

For Official Use

NEA/RWM/IGSC(2003)4



Organisation de Coopération et de Développement Economiques
Organisation for Economic Co-operation and Development

28-May-2003

English - Or. English

**NUCLEAR ENERGY AGENCY
RADIOACTIVE WASTE MANAGEMENT COMMITTEE**

**NEA/RWM/IGSC(2003)4
For Official Use**

Integration Group for the Safety Case (IGSC)

WORKSHOP PROCEEDINGS ON:

ENGINEERED BARRIER SYSTEMS (EBS) IN THE CONTEXT OF THE ENTIRE SAFETY CASE

**Held in Oxford, United Kingdom
on 25-27 September 2002**

In co-operation with the European Commission and hosted by United Kingdom Nirex Limited

JT00145158

Document complet disponible sur OLIS dans son format d'origine
Complete document available on OLIS in its original format

English - Or. English

Radioactive Waste Management

**Engineered Barrier Systems (EBS)
in the Context of the Entire Safety Case**

**Workshop Proceedings
Oxford, United Kingdom
25-27 September 2002**

**In co-operation with the
European Commission
and hosted by
United Kingdom Nirex Limited**

© OECD 2003

NUCLEAR ENERGY AGENCY
ORGANISATION FOR ECONOMIC CO-OPERATION AND DEVELOPMENT

ORGANISATION FOR ECONOMIC CO-OPERATION AND DEVELOPMENT

Pursuant to Article 1 of the Convention signed in Paris on 14th December 1960, and which came into force on 30th September 1961, the Organisation for Economic Co-operation and Development (OECD) shall promote policies designed:

- to achieve the highest sustainable economic growth and employment and a rising standard of living in Member countries, while maintaining financial stability, and thus to contribute to the development of the world economy;
- to contribute to sound economic expansion in Member as well as non-member countries in the process of economic development; and
- to contribute to the expansion of world trade on a multilateral, non-discriminatory basis in accordance with international obligations.

The original Member countries of the OECD are Austria, Belgium, Canada, Denmark, France, Germany, Greece, Iceland, Ireland, Italy, Luxembourg, the Netherlands, Norway, Portugal, Spain, Sweden, Switzerland, Turkey, the United Kingdom and the United States. The following countries became Members subsequently through accession at the dates indicated hereafter: Japan (28th April 1964), Finland (28th January 1969), Australia (7th June 1971), New Zealand (29th May 1973), Mexico (18th May 1994), the Czech Republic (21st December 1995), Hungary (7th May 1996), Poland (22nd November 1996), Korea (12th December 1996) and the Slovak Republic (14 December 2000). The Commission of the European Communities takes part in the work of the OECD (Article 13 of the OECD Convention).

NUCLEAR ENERGY AGENCY

The OECD Nuclear Energy Agency (NEA) was established on 1st February 1958 under the name of the OEEC European Nuclear Energy Agency. It received its present designation on 20th April 1972, when Japan became its first non-European full Member. NEA membership today consists of 28 OECD Member countries: Australia, Austria, Belgium, Canada, Czech Republic, Denmark, Finland, France, Germany, Greece, Hungary, Iceland, Ireland, Italy, Japan, Luxembourg, Mexico, the Netherlands, Norway, Portugal, Republic of Korea, Slovak Republic, Spain, Sweden, Switzerland, Turkey, the United Kingdom and the United States. The Commission of the European Communities also takes part in the work of the Agency.

The mission of the NEA is:

- to assist its Member countries in maintaining and further developing, through international co-operation, the scientific, technological and legal bases required for a safe, environmentally friendly and economical use of nuclear energy for peaceful purposes, as well as
- to provide authoritative assessments and to forge common understandings on key issues, as input to government decisions on nuclear energy policy and to broader OECD policy analyses in areas such as energy and sustainable development.

Specific areas of competence of the NEA include safety and regulation of nuclear activities, radioactive waste management, radiological protection, nuclear science, economic and technical analyses of the nuclear fuel cycle, nuclear law and liability, and public information. The NEA Data Bank provides nuclear data and computer program services for participating countries.

In these and related tasks, the NEA works in close collaboration with the International Atomic Energy Agency in Vienna, with which it has a Co-operation Agreement, as well as with other international organisations in the nuclear field.

© OECD 2003

Permission to reproduce a portion of this work for non-commercial purposes or classroom use should be obtained through the Centre français d'exploitation du droit de copie (CCF), 20, rue des Grands-Augustins, 75006 Paris, France, Tel. (33-1) 44 07 47 70, Fax (33-1) 46 34 67 19, for every country except the United States. In the United States permission should be obtained through the Copyright Clearance Center, Customer Service, (508)750-8400, 222 Rosewood Drive, Danvers, MA 01923, USA, or CCC Online: <http://www.copyright.com/>. All other applications for permission to reproduce or translate all or part of this book should be made to OECD Publications, 2, rue André-Pascal, 75775 Paris Cedex 16, France.

EXECUTIVE SUMMARY

Repositories for the disposal of radioactive waste generally rely on a multi-barrier system to isolate the waste from the biosphere. This multi-barrier principle creates an overall system robustness that enhances confidence that the waste will be successfully contained.

The multi-barrier system typically comprises the natural (geological) barrier provided by the repository host rock and its surroundings, and an engineered barrier system (EBS). Ensuring that an EBS will perform its desired functions requires integration of site-characterisation data, data on waste properties, data on engineering properties of potential barrier materials, *in situ* and laboratory testing, and modelling.

In 2002, the Integration Group for the Safety Case (IGSC) of the Nuclear Energy Agency (NEA) wished to reassess the need for a project to develop a greater understanding of how to achieve the necessary integration for the successful design, construction, testing, modelling and performance assessment of engineered barrier systems. To this end a workshop was held under the joint auspices of the EC and the NEA, hosted by United Kingdom Nirex Limited (Nirex), at Keble College, Oxford on 25-27 September 2002. The workshop was attended by 40 delegates representing 15 countries and the NEA-EC sponsors. The workshop was intended to provide a status report on engineered barrier systems in various national programmes, to establish the value to member countries of a project on EBS and, if supported, to define the project's scope, timetable and *modus operandi*. In particular, the workshop was to consider the need to reduce the number of subsequent workshops, as compared with a previous proposal for a project on EBS. This report summarises the joint NEA-EC workshop entitled "Engineered Barrier Systems in the Context of the Entire Safety Case".

It was agreed that there was strong support amongst the many countries represented for continued international co-operation between the NEA and the EC on the NEA project on EBS, and that it was important to present as an overall outcome an account of how EBS design is developed, justified and implemented using state-of-the-art knowledge. It was also agreed that the project would be best served by a sequence of further workshops as follows:

Workshop 1	Design Requirements and Constraints.
Workshop 2	Process Issues: <ul style="list-style-type: none"> • Thermal management and analysis. • Alteration of non-metallic barriers and evolution of solution chemistry. • Radionuclide release and transport.
Workshop 3	Role of Performance Assessment and Process Models.
Workshop 4	Design Confirmation and Demonstration.

This sequence of workshops will lead the NEA-EC EBS project through an optimisation cycle of the type discussed at the workshop.

Acknowledgements

On behalf of all participants, the NEA wishes to express its gratitude to United Kingdom Nirex Limited, which hosted the workshop in Oxford, as well as to the EC for its co-operation in this joint EC/NEA project.

Special thanks are also due to:

- The members of the Workshop Programme Committee¹ who structured and conducted the workshop.
- David Bennett, Galson Sciences Limited (United Kingdom) who helped the Secretariat and the programme committee in drafting the workshop synthesis.
- The working group chairpersons and rapporteurs who led and summarised the debates that took place in the five working groups.
- The speakers for their interesting and stimulating presentations and all participants for their active and constructive contribution.

¹. Members of the committee were: Jesus Alonso (ENRESA, Spain), Richard Beauheim (SNL, USDOE-WIPP, USA), Alan Hooper (UK Nirex Limited, UK), Bob MacKinnon (SNL, US DOE-YMP, USA), Henning von Maravic (EC), Frédéric Plas (Andra, France), Patrik Sellin (SKB, Sweden), Oïvind Töverud (SKI, Sweden), Frank Wong (US DOE-YMP, USA), Hiroyuki Umeki (NUMO, Japan) and Sylvie Voinis (OECD, NEA, France).

TABLE OF CONTENTS

EXECUTIVE SUMMARY	5
1. INTRODUCTION	9
2. WORKSHOP OBJECTIVES AND AGENDA	13
3. EBS FUNCTION, DESIGN, CHARACTERISATION AND ASSESSMENT	15
EBS Function, Design and Characterisation.....	15
EBS Modelling and Performance Assessment	18
4. WORKING GROUP SESSIONS	21
Working Group A: Design Criteria and Construction	21
Working Group B: Thermo-Hydro-Mechanical (THM) Processes	22
Working Group C: Geochemical Processes.....	24
Working Group D: Radionuclide Release and Migration	26
5. WORKSHOP CONCLUSIONS	31
Technical Issues.....	31
Programmatic Issues.....	33
REFERENCES	35
<i>Appendix A: WORKSHOP AGENDA.....</i>	<i>37</i>
<i>Appendix B: PAPERS PRESENTED TO THE WORKSHOP</i>	<i>41</i>
Managing Design Requirements for a Repository in Crystalline Rock.....	43
Managing Design Requirements of the French HLLW programme in clay media	45
Closure Concept for the Morsleben LLW Repository for Radioactive Waste Design of Drift Seals in a Former Salt Mine.....	53
CROP – A Project for Comparative Description of National Concepts for Disposal of Radioactive Waste	67
The Role of the EBS in Demonstrating Post-Closure Safety of the Proposed Yucca Mountain Repository	83
Engineered Barriers System Modelling and Performance Assessment in SAFIR 2.....	95

EBS Modelling and Performance Assessment from H12: Results, Conclusions and Future Priorities.....	101
On-Going Activities of the EC Project “BENIPA” Current Status, Key Issues and Achievements.....	117
<i>Appendix C:</i> Remit and Composition of Working Groups	131
Working Groups Remit	133
Working Groups Composition	143
<i>Appendix D:</i> List of Participants	145

List of Figures

Figure 1.	The development process for the Finnish disposal system	14
Figure 2.	One of the current French design options for the disposal of vitrified high-level waste, including a bentonite buffer.....	15
Figure 3.	Example of a model of water saturation in the excavation-disturbed zone (EDZ) from the EC CROP Project.....	16
Figure 4.	The current conceptual design for the EBS at the proposed Yucca Mountain repository	17
Figure 5.	Example grid from a deterministic model of radionuclide transport in the near-field developed as part of the EC BENIPA Project.....	18
Figure 6.	Steps in the development of a disposal system design	20

List of Tables

Table 1.	Geochemical issues considered by Working Group C	23
Table 2.	“Internal” and “External” Components of the EBS25	25
Table 3.	Geochemical and radionuclide transport issues relevant to the Internal EBS Components.....	26
Table 4.	Processes influencing mass transport in the External EBS Components	27
Table 5.	Common issues to be considered at future workshops	28
Table 6.	Aims of proposed future EBS project workshops.....	32

INTRODUCTION

Repositories for disposal of radioactive waste generally rely on a multi-barrier system to isolate the waste from the biosphere. This multi-barrier principle creates an overall system robustness that enhances confidence that the waste will be successfully contained. The multi-barrier system typically comprises the natural (geological) barrier provided by the repository host rock and its surroundings, and an engineered barrier system (EBS).

An EBS may itself comprise a variety of components, such as the waste form, waste canisters, buffer, backfill, seals, and plugs. The general purpose of an EBS is to prevent and/or delay the release of radionuclides from the waste to the repository host rock, at least during the first several hundred years after repository closure when the fission-product content is high, and where they might be mobilised by natural groundwater flow. In many disposal concepts, the EBS, operating under stable and favourable geosphere conditions, is designed to contain most of the radionuclides for much longer periods.

The specific role that an EBS is designed to play in a particular waste disposal concept is dependent on the conditions that are expected (or considered possible) to occur over the period of regulatory interest, and the anticipated performance of the natural geological barrier. To be effective, an EBS must be tailored to the specific environment in which it is to function. Consideration must be given to factors such as the heat that will be produced by the waste, the pH and redox conditions that are expected, the expected groundwater flux, the local groundwater chemistry, possible interactions among different materials in the waste and EBS, the mechanical behaviour of the host rock after repository closure, and the evolution of conditions over time. Ensuring that an EBS will perform its desired functions requires an integration, often iterative, of site characterisation data, data on waste properties, data on engineering properties of potential barrier materials, “*in situ* and laboratory testing”, and modelling.

In 2002, the Integration Group for the Safety Case (IGSC) of the Nuclear Energy Agency (NEA) wished to assess the need for a project to develop a greater understanding of how to achieve the necessary integration for successful design, construction, testing, modelling, and performance assessment of engineered barrier systems.

To this end a workshop was held under the joint auspices of the EC and the NEA, hosted by United Kingdom Nirex Limited (Nirex), at Keble College, Oxford on 25-27 September 2002. The workshop was attended by 40 delegates representing 15 countries and the EC/NEA sponsors. It was intended to provide a status report on engineered barrier systems in various national programmes, to establish the value to member countries of a project on the EBS and, if supported, to define its outline scope, timetable and *modus operandi*. In particular, the workshop was to consider the need to reduce the number of subsequent workshops, as compared with a previous proposal for a project on the EBS. This report summarises the joint NEA-EC workshop entitled “Engineered Barrier Systems in the Context of the Entire Safety Case”.

EBS performance can be considered according to four main themes:

- Engineering design perspective, e.g., how can a component be (re-)engineered to improve performance or ease of modelling?
- Characterisation perspective, e.g., how can properties of the EBS and the conditions under which it must function be measured or otherwise characterised?
- Modelling perspective, e.g., how well can the relevant processes be modelled?
- Performance assessment perspective, e.g., how can the performance of the EBS and/or its components be evaluated under a wide range of conditions?

These themes formed the basis for the discussions at the workshop, which was intended to promote interaction and collaboration among experts responsible for engineering design, characterisation, modelling, and performance assessment of engineered barrier systems. The workshop also examined interactions between the EBS and the near-field host rock as well as radionuclide releases from the near-field to the far-field.

In organising the workshop, the IGSC intended to develop a greater understanding of how to achieve the integration needed for successful design, construction, testing, modelling, and performance assessment of engineered barrier systems, and to clarify the role that an EBS can play in the overall safety case for a repository. A safety case is a collection of arguments, at a given stage of repository development, in support of the long-term safety of the repository. A safety case includes the quantitative results derived from performance assessment modelling, but also considers aspects of barrier performance that are difficult to quantify but can qualitatively be shown to enhance the robustness of the system.

To set the context for the Oxford workshop, the EC provided support for the production of a state-of-the-art report based on responses to an NEA questionnaire on the EBS. The state-of-the-art report thus developed (NEA-EC 2003) is an important early product from the EBS project. To evaluate progress during the EBS project, it is intended to develop a further state-of-the-art report at the end of the project, in 2006.

Recognising the diversity in engineered barrier systems in various national programmes, as shown by the recent state-of-the-art report (NEA-EC 2003), the project is seeking to share knowledge and experience about the integration of EBS functions, engineering design, characterisation, modelling and performance evaluation in order to understand and document the state of the art, and to identify the key areas of uncertainty that need to be addressed. Specific objectives are to:

- Understand the relationship between the functions to be served by the EBS and its design in different repository contexts.
- Compare different methods of characterising EBS properties.
- Compare different approaches to modelling of the EBS.
- Compare different means of evaluating EBS performance.
- Compare different engineering approaches to similar problems.
- Compare techniques for evaluating, characterising, and modelling interactions between the EBS and near-field host rock.

This report is structured as follows:

- Section 2 summarises the objectives and components of the workshop.
- Section 3 summarises the presentations and discussions on the opening day of the workshop, regarding the function, design, characterisation and assessment of the EBS.
- Section 4 summarises results from four working group sessions, which were held during the second and third days of the workshop.
- Section 5 presents the overall conclusions from the workshop.
- Section 6 provides a list of references.

WORKSHOP OBJECTIVES AND AGENDA

The workshop Agenda is contained in Appendix A. The workshop began with welcoming addresses from Sylvie Voinis (NEA), Henning von Maravic (EC) and Alan Hooper (Nirex). Hiroyuki Umeki (NUMO) then described the background to the NEA IGSC-EBS Project (Section 1), and the specific objectives of the first workshop as follows:

- To consider a balanced range of waste management options and disposal concepts, and to consider a range of repository host rock media.
- To focus on the state-of-the-art regarding EBS design, characterisation, implementation, understanding and assessment, in order to obtain a general picture of the status of each national waste management programme.
- To design the outlines of a programme for the IGSC-EBS Project and, more specifically, to arrive at an appropriate number of subsequent workshops.

David Bennett (GSL) then summarised the responses from the organisations participating in the IGSC-EBS Project to the NEA's EBS questionnaire (see Section 5.1 and NEA-EC 2003). The first day of the workshop then continued with presentations (see Appendix B) on two main themes:

- (i) EBS function, design and characterisation.
- (ii) EBS modelling and performance assessment.

The second day and part of the morning on the third day were devoted to working group sessions. Four working groups (see Appendix C) were convened to consider the following topics:

- Working Group A: Design Criteria and Construction.
- Working Group B: Thermo-Hydro-Mechanical (THM) Processes.
- Working Group C: Geochemical Processes.
- Working Group D: Radionuclide Release and Migration.

The objectives of each working group were to identify relevant issues that it might be practical to address within an international project, and to develop proposals for subsequent workshops to address key issues.

The third day of the workshop continued with a plenary session, at which the results of the working groups were presented to the full range of participants. This was followed by a meeting of the Project Steering Committee, at which the future organisation of the IGSC-EBS Project was discussed. A final plenary session was held to discuss the outcomes of the workshop, which were summarised by Alan Hooper and David Bennett.

EBS FUNCTION, DESIGN, CHARACTERISATION AND ASSESSMENT

The following sections summarise the contents and main conclusions of the papers presented to the workshop on the first day. The papers themselves are contained in Appendix B.

EBS Function, Design and Characterisation

Timo Äikäs (POSIVA) described the Finnish experience and the various types of constraints and requirements that can affect the design of a repository situated in crystalline rock. An iterative scheme for repository development, or “optimisation cycle”, was presented (Figure 1). The scheme depicted in Figure 1 is a development of earlier schemes (e.g., Bennett *et al.* 1998; JNC 2000; POSIVA 2000), enhanced to place greater emphasis on the role of demonstration experiments. The concept of “requirements management” was described. It was emphasised that systematic consideration of requirements can help to:

- Improve disposal system understanding.
- Increase and maintain transparency, traceability and clarity regarding:
 - The treatment of a comprehensive set of requirements.
 - The justification of requirements.
 - The verification of requirements.
 - Design change control.
- Enhance stakeholder dialogue.
- Identify research needs and integrate different disciplines.
- Prioritise technical developments on significant system components.
- Recognise “available design space” and identify room for optimisation.

The need for the production of clear documentation was also emphasised in order that that future generations operating the repository and after its closure understand what was originally intended in terms of repository design and performance.

Frederic Plas (Andra) summarised French regulatory constraints on radioactive waste disposal, particularly those constraints relevant to the EBS, and then described Andra’s current design concepts for a repository in clay host rocks (e.g., Figure 2). Results from Andra’s first safety assessment, which have been documented in the “Dossier Argile 2001”, were presented, and general conclusions and perspectives discussed. It was emphasised that the EBS components have a primary role in waste containment during operational phase and during the post-closure phase until from 1 000 (e.g. vitrified waste) to 10 000 years (case of spent fuel) although the fabrication defects according to the large amount of waste packages need to be taken into account in the safety analysis. The choice of practical conditions for the retrievability of the waste packages may provide a significant additional constraint on repository and EBS designs. It was also suggested that simpler designs might help to minimise interactions between EBS materials, and that potentially significant remaining uncertainties

are associated with the properties of the excavation-disturbed zone (EDZ) and with gas generation in long-lived Type B or Intermediate-Level Wastes (ILW).

Figure 1. The development process for the Finnish disposal system (after Äikäs *et al.* Appendix B)

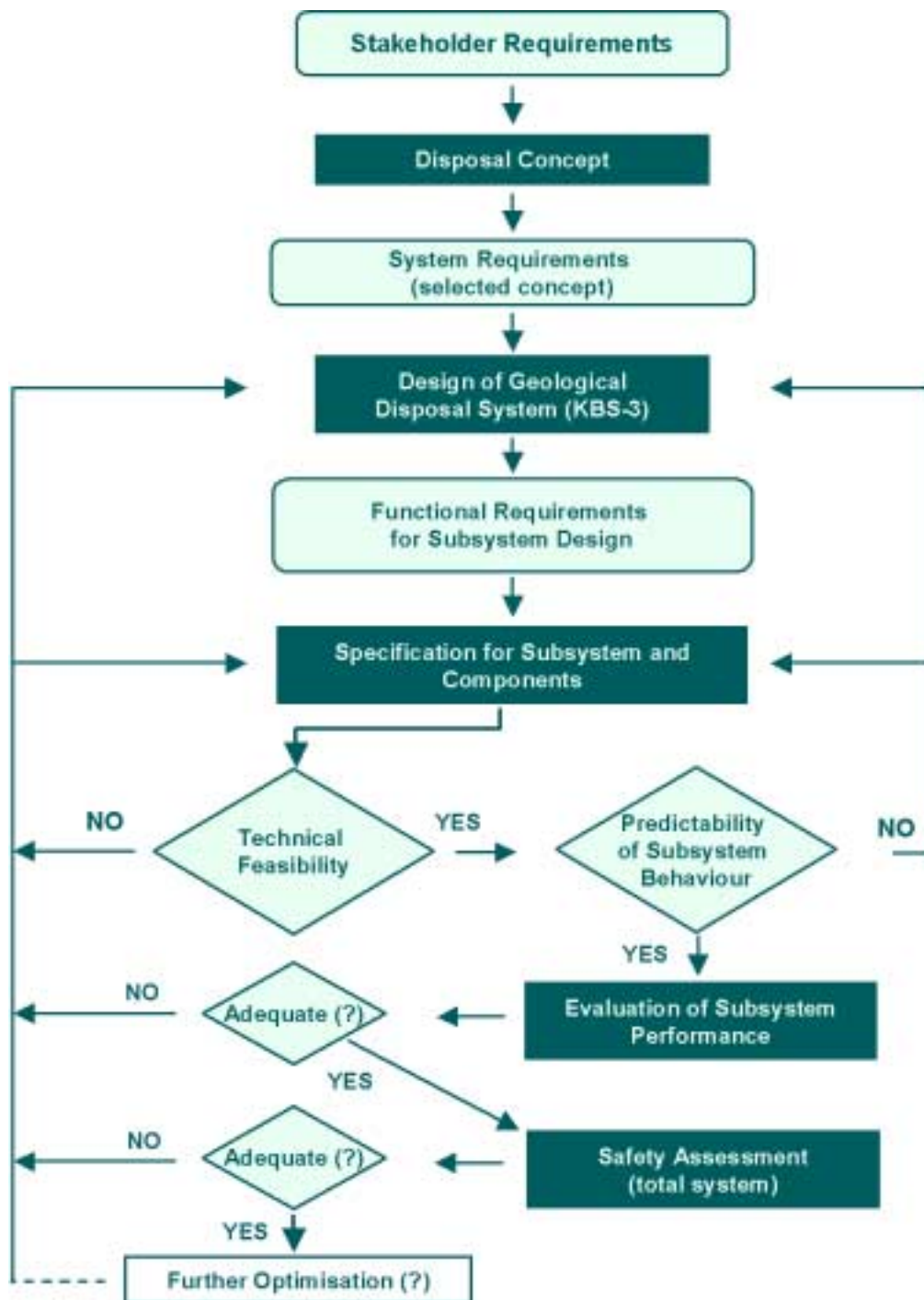
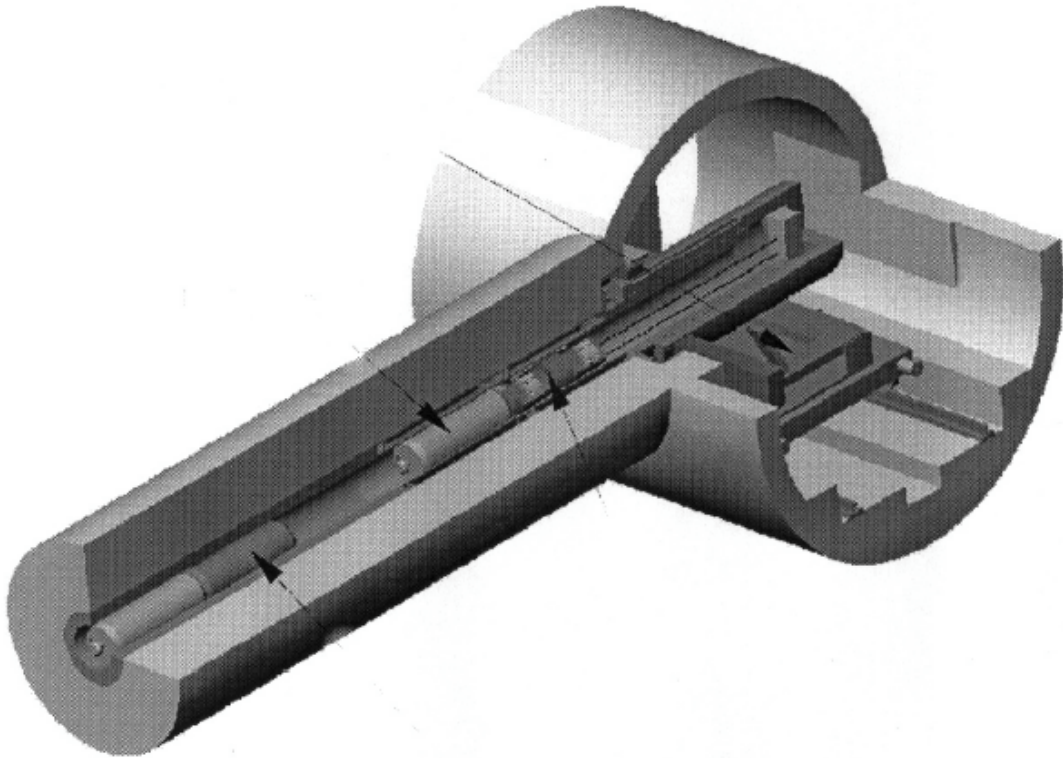

Figure 2. **One of the current French design options for the disposal of vitrified high-level waste, including a bentonite buffer (after Plas *et al.* Appendix B)**



The importance of demonstration experiments to developing a successful and convincing safety case was again highlighted, as was the need for progressive improvement in understanding system behaviour, which enables otherwise overly conservative design requirements to be relaxed (optimised).

Nina Müller-Hoeppe (DBE) and Ralph Mauke (BFS) presented a paper that discussed EBS design requirements for a repository in a salt host rock. They noted that design of the Morsleben drift seals necessitated a comprehensive analysis of site-specific information, an extensive investigation of the properties of the salt-concrete EBS material, and consideration of information from long-term safety assessment. These considerations lead to a simple and robust design for the drift seals and a practicable approach for demonstrating compliance with relevant requirements. Development of the EBS concept for the Morsleben facility is scheduled to be completed in 2003, and this will be followed by initiation of a licensing procedure.

Roland Pusch (Geodevelopment AB) presented a summary of the EC Cluster Repository Project (CROP). CROP is considering aspects of repository design and construction, the instrumentation of Underground Research Laboratory (URL) experiments, and the testing of theoretical models. In particular, the CROP Project is focusing on the buffer, backfill and seals, and their interaction with the EDZ. An example of some of the modelling work performed during the CROP project is illustrated in Figure 3. The presentation identified several technical issues where potentially significant uncertainties remain including the properties of the EDZ. In the discussion

following the paper it was agreed that the IGSC-EBS Project is broader in scope than the EC CROP Project, as the former involves a wider range of countries and disposal concepts, and also because it is considering the full range of engineered barriers. It was agreed that because of its nature and scope, it is both possible and appropriate for the IGSC-EBS Project to take a more strategic view than individual EC research projects. The NEA and EC projects are complementary and it was agreed that it would be beneficial to ensure efficient transfer of information between them.

Figure 3. **Example of a model of water saturation in the excavation-disturbed zone (EDZ) from the EC CROP Project (after Pusch and Svemar Appendix B)**

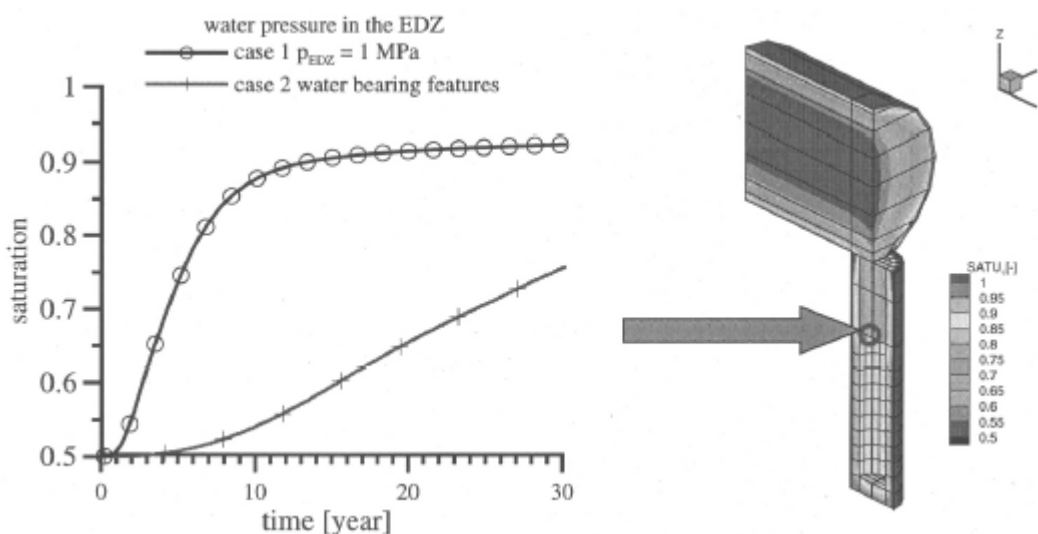

Following the presentations in this section of the workshop, discussions amongst the workshop participants centred on the requirement for, and nature of, the iterative process described in the Finnish paper, and on the need for the requirements of the EBS to be clearly identified and for constraints on EBS design to be clearly and traceably documented.

EBS Modelling and Performance Assessment

Robert MacKinnon (SNL) described the role of the EBS in demonstrating post-closure safety of the proposed Yucca Mountain repository. The paper encompassed key repository design assumptions and requirements, an overview of the proposed Yucca Mountain repository and EBS (Figure 4), discussion of EBS processes and models, and the approach to the post-closure safety case. The Yucca Mountain EBS is designed to provide defence in depth and operational flexibility, particularly with regard to the emplacement of various heat-generating wastes streams. Like several other national programmes, the Yucca Mountain Project is taking an iterative approach to design. It was emphasised that a disposal programme needs to be sufficiently mature and to have conducted several iterations in order that modelling tools are sufficiently developed to inform design choices meaningfully.

Jean-Paul Boyazis (Ondraf/Niras) and Xavier Sillen (SCK•CEN) described the approaches taken in the recent Belgian SAFIR 2 state-of-the-art report concerning technical and scientific aspects of high-level waste (HLW) and ILW disposal in poorly indurated clays. For a repository in a clay host rock, such as the Boom Clay, the contribution of the EBS to the overall performance of the disposal system is minor when considering the normal evolution scenario.

Figure 4. **The current conceptual design for the EBS at the proposed Yucca Mountain repository (after MacKinnon Appendix B)**

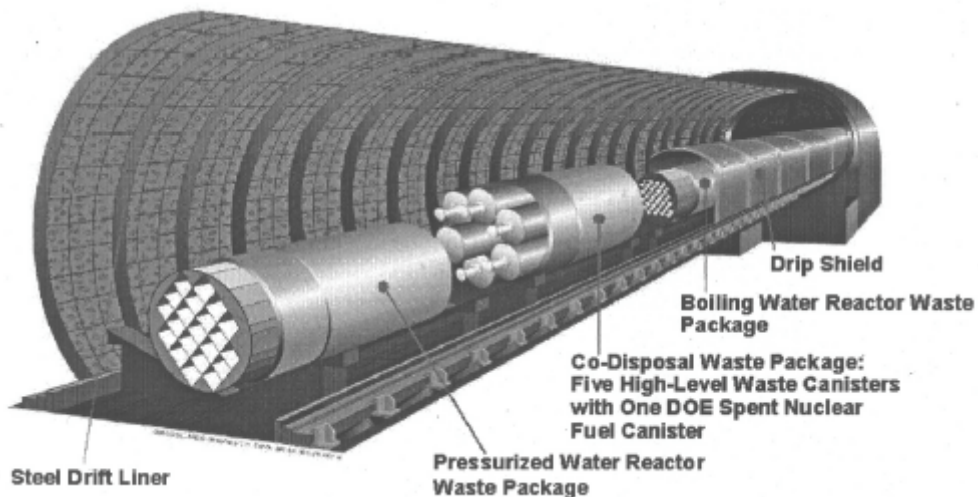

This is because the radionuclide travel time in the buffer (the EBS component that hinders radionuclide migration most efficiently) is much shorter than in the host rock. However, the properties of the EBS can be of paramount importance to the overall safety of the repository in altered evolution scenarios in which the host rock barrier is breached, such as those involving poor repository sealing or human intrusion. For such scenarios, key issues relate to the hydraulic / mechanical properties of the buffer, the waste form dissolution rate and the canister lifetime. The EBS also plays an important role during the operational phase. The main conclusions from SAFIR 2 include increased confidence in the suitability of the Belgian Boom Clay to act as an effective barrier to radionuclide migration. In the post-SAFIR 2 era, the Belgian programme is working to derive a new EBS design by more systematically linking barrier design to safety functions, and by tailoring EBS design to the properties and characteristics of the host rock.

Hiroyuki Umeki (NUMO) described results and conclusions from the EBS modelling and performance assessment studies that supported the recent Japanese H12 report (JNC 2000). H12 evaluated the long-term safety of a Japanese repository concept at the generic stage using integrated performance assessment methods. In the H12 evaluation, considerable emphasis was placed on the performance of the near-field. In future stages of the Japanese programme, the engineered barriers will be optimised, site-specific geological features will be characterised, and understanding of safety-relevant phenomena will continue to be enhanced in order to allow more realistic modelling. It is also intended to create closer links between repository design, site characterisation and performance assessment, to conduct a range of technical studies on the EBS, and to further enhance performance assessment methods to account for spatial heterogeneity, groundwater flow through the EDZ, and the geometric complexity and effects of multiple radionuclide sources within the repository.

Jesus Alonso (ENRESA) described activities within the EC BENIPA (Bentonite in Integrated Performance Assessment) project. Activities within the BENIPA project include:

- Documenting the functions of bentonite buffer materials envisaged for repositories sited in clay and fractured granite host rocks, and defining reference cases for detailed modelling assessment. The reference cases being considered are based on the FEBEX experiment and the conceptual disposal system in the Boom Clay at Mol in Belgium.
- A review of features, events and processes (FEPs) that can influence bentonite buffer behaviour, and collation of reference data for use in for detailed modelling assessment.
- Evaluation and application of process-level and performance assessment models to analyse buffer performance. A wide range of detailed calculations is being performed to evaluate a variety of Thermo-Hydro-Mechanical-Chemical (THMC) processes (Figure 5).
- The conduct of sensitivity and optimisation analyses.

Figure 5. **Example grid from a deterministic model of radionuclide transport in the near-field developed as part of the EC BENIPA Project (after Alonso *et al.* Appendix B)**

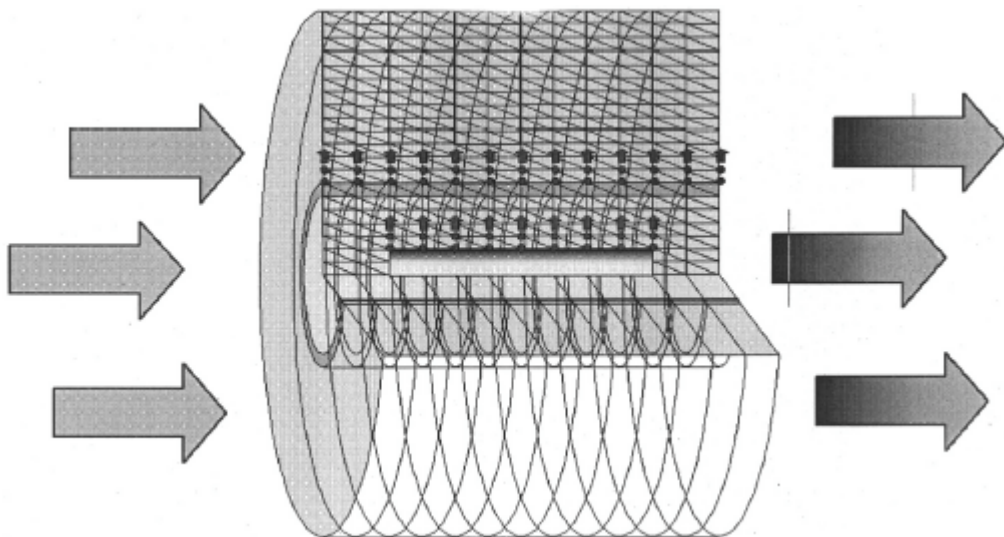

WORKING GROUP SESSIONS

The following sections summarise the results of the discussions by the four working groups. The remit and membership of the working groups are detailed in Appendix C.

Working Group A: Design Criteria and Construction

The EBS comprises a variety of components, including the waste form itself, waste canisters, backfill, seals and plugs. The general purpose of an EBS is the containment and long-term minimisation/retardation of radionuclide releases. The specific role that an EBS is designed to play in a particular waste disposal concept is dependent on the design and on the site-specific conditions. This role may be defined in the design criteria.

The group considered a number of topics related to design criteria and construction, and developed proposals for two subsequent workshops to address some of the issues identified. The workshops would draw on a mix of specialists from engineering, EBS characterisation, and process modelling and safety assessment. The potential objectives and contents of each proposed workshop are described in the following sections.

Design Requirements and Constraints

The group noted that the development of an EBS design proceeds from societal and stakeholder requirements, to system requirements, to a design concept, to a detailed design and, thus, to practical decisions on implementation (Figure 6). These requirements are influenced by constraints such as site characteristics, existing waste packages, mining technology, national waste inventory, and operational safety.

It was, therefore, proposed to have a workshop on the topic of design requirements and constraints with the following objectives:

- State the design requirements for various facilities and identify their basis, including the evolution of these requirements.
- Promote common understanding of the requirements, and of methods for linking between societal and stakeholder requirements to detailed design concepts and decisions.
- Share ideas and experiences on working with challenging requirements and constraints.
- Better understand the basis for differences in national EBS designs.

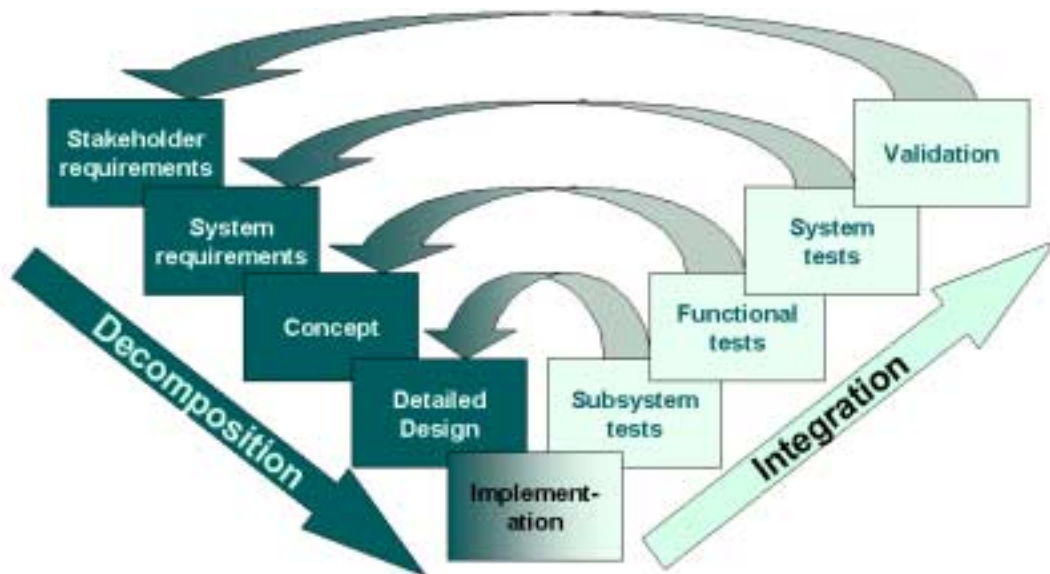
Figure 6. Steps in the development of a disposal system design (after Äikäs *et al.* Appendix B)

Qualification / Reliability of EBS

The EBS operates on a long time scale. It also has to perform in a range of conditions, during manufacture, emplacement, operation, monitoring, and the transient and long-term post-closure phases. Establishing the reliability of the EBS under these conditions, or “qualifying” its performance (which has a legal meaning in some national programmes) is a challenging task. Such qualification requires identifying and understanding the main processes and parameters that affect disposal system performance and, since this requires knowledge of the behaviour of the host rock, qualification is a site-specific issue.

The group, therefore, proposed a workshop on the topic of the qualification or reliability of the EBS with the following objectives to:

- Exchange ideas and experience on methods to qualify or build confidence in EBS performance requirements (e.g., theoretical studies, modelling, accelerated testing, URL/prototype tests, natural and man-made analogues, *in situ* monitoring).
- Promote international co-operation and understanding of common methods for qualification in a regulatory environment.

Working Group B: Thermo-Hydro-Mechanical (THM) Processes

Host rock excavation, construction of an EBS, and the operation of a repository cause changes in the stress regime and the hydraulic conditions in the surrounding rock. The closure and sealing of the repository also affect the hydro-mechanical evolution of the system. Furthermore, the emplacement of heat-generating wastes modifies the temperature of the disposal system and this affects the thermo-hydro-mechanical-chemical evolution of the system through a range of coupled processes. Medium-term (100s years) and long-term (1 000s years) changes in environmental conditions and alterations in the properties of the EBS materials and the surrounding rock may also influence the performance of the disposal system.

One difficulty the working group had was limiting its attention to THM processes only, since it was recognised that proper investigation of THM effects could only be achieved by consideration of chemical processes, and changes in chemical properties could, in turn, only be confidently resolved by consideration of THM processes.

The performance and design of an EBS are not dependent solely on the undisturbed ambient conditions and the initial properties of the EBS materials and repository host rock, but depend on how those conditions and properties change as a result of repository construction, operation and waste emplacement. These repository-induced influences evolve in a complicated manner that depends on the type of waste, host rock formation, and EBS design. The manner in which the properties and THMC conditions in the EBS and host rock are affected is further dependent on factors such as the rock excavation methods used, the duration of operations prior to closure, the heterogeneities and discontinuities in the host rock, the engineering measures taken to maintain excavation stability and reduce water inflows, the chemical and mechanical properties of the materials used for backfilling and sealing, and the thermal load to which the rock is subjected.

To help focus its discussion, Group B first reviewed the definition of the near-field environment. For the purposes of the group's discussion, and consistent with the IGSC-EBS Project definition, the near-field environment was considered to include the EBS and that portion of the rock mass in which there would occur significant change (temporary or permanent) in THMC properties. These changes would arise from mining, heat transfer, mechanical deformations and stresses, and mass-transfer exchange between underground facilities and the surrounding host rock, including fluid mobilisation, degassing, phase changes, weathering of minerals, precipitation of new phases, and introduction of biological organisms.

To characterise the near-field environment it may be necessary to consider a range of coupled processes, including the couplings between thermal, hydrological, mechanical, and chemical processes, as well as possible associated impacts from biological and radiological processes. For example, heat from the waste can cause thermal gradients, which induce mechanical stresses and deformations, which can mobilise water, which can subsequently dissolve minerals. Gas generation, due to biodegradation of organic materials in the waste, can lead to two-phase flow conditions in the buffer and induce additional water movement, mechanical stresses, and chemical processes.

The group concluded that all of the key processes described above need to be considered in order to establish appropriate design requirements for the EBS, and to evaluate the performance of the EBS and the repository in a safety case. The group also considered that some of the key processes need to be better understood. The group felt that modelling of coupled processes, experiments and field (URL) measurements are essential for the development of a better understanding of the key processes, and for devising sensible and technically-defensible design criteria based on scientific understanding rather than arbitrary assumptions.

The group developed proposals for workshops on five topics:

1. Thermal management and analysis.
2. Upscaling and extrapolation.
3. EBS scenarios (including consideration of fabrication and operational errors).
4. Retrievability and monitoring.
5. Gas in repository systems.

Of the range of topics considered, the group considered that developing a better understanding of thermal loading and management is a priority for establishing appropriate design requirements. The treatment of uncertainties, arising from upscaling in space and extrapolation over time of processes and properties, was also considered to be an important issue that needs to be addressed. The objectives of the proposed workshops on thermal management and analysis, and on upscaling and extrapolation are summarised below.

Thermal Management and Analysis

The objective of a workshop on thermal management and analysis would be to evaluate existing data, models, and safety considerations and consider maximum temperature limits for the EBS and the near-field. Key issues and questions to address would include:

- What THMC processes need to be considered?
- How do you model relevant THMC processes and what analyses are needed?
- How can uncertainty and evolution of properties be considered?
- What data and experiments are needed to better characterise THMC processes?
- Is there a need to specify thermal design constraints or limits? If so, should they be specified in terms of temperature, power density or some other measure, and at what level might such constraints be established?

Upscaling and Extrapolation

The objective of a workshop on THMC upscaling and extrapolation would be to identify remaining uncertainties and explore approaches to their resolution. Key issues and questions to address would include:

- How do you design “scaled” experiments to account for processes at large scales and/or long time frames?
- How do you scale-up laboratory and field properties to account for natural variability?
- How do you account for long-term evolution of properties?

Working Group C: Geochemical Processes

Group C focused on identifying suitable topics within the area of geochemistry for further development under the IGSC-EBS Project.

The group began with a brainstorming session to identify important geochemical issues. These issues were then gathered into areas that could sensibly be considered during a workshop. The potential workshops thus identified were then evaluated in terms of their relevance to the range of radioactive waste management programmes represented within the IGSC-EBS Project, and in terms of their potential to promote meaningful international co-operation.

The list of issues identified by the group is presented in Table 1. It is recognised that the list contained in Table 1 is neither comprehensive, nor are the items independent.

The group considered the potential benefits of international workshops in the areas of corrosion, solution chemistry, the alteration of non-metallic engineered barriers, and nuclear criticality. The group concluded that it should recommend a single workshop that encompassed both solution chemistry and the alteration of non-metallic engineered barriers. The rationale for such a workshop is described in the following section.

Table 1. **Geochemical issues considered by Working Group C**

Issue	Notes
Establishment of the geochemical environment	The chemical environment of the near-field will evolve after repository closure and influence radionuclide release and disposal system performance.
Corrosion	Corrosion of metal containers/canisters may determine the containment period, but may also have an effect on the geochemical environment.
Solution chemistry	The chemistry of the water in the near-field will have a significant effect on all geochemical processes. Important parameters include, pH, redox conditions, ionic strength and the concentrations of inorganic and organic ligands.
Thermal evolution	Elevated temperatures and thermal gradients will influence the chemistry of waters in the near-field and the behaviour of EBS materials.
Alteration of EBS materials	The chemical degradation of buffer and backfill materials over repository time scales will influence disposal system performance.
Corrosion product effects	Canister corrosion products may become abundant in the near-field for many repository concepts.
Buffer erosion	Low ionic-strength (dilute) waters may have a physical effect on clay-based EBS materials.
Colloid formation	Degradation of EBS barriers may lead to colloid generation.
Microbes	It is almost impossible to exclude microbial activity in the repository.
Additives	The secondary effects of components that are added to EBS materials to enhance repository performance are uncertain.

Solution Chemistry and the Alteration of Non-metallic Engineered Barriers

Solution Chemistry

In order to evaluate the potential for radionuclide transport away from a waste repository and to assess the long-term performance of the EBS and the disposal system, it is essential to understand the composition and chemistry of waters in the repository. Information about relevant processes that affect water compositions and chemistry can be gathered from field and laboratory experiments, thermodynamic databases, scientific models and expert judgement. This information may be used to develop a model of solution chemistry. Ideally, such a model would feature all of the significant processes and their couplings, and would account for the temporal and spatial evolution of relevant components.

The group considered that the treatment of solution chemistry would be a good topic for a NEA workshop for the following reasons:

- Solution chemistry will affect EBS performance as well as radionuclide transport and disposal system performance.
- Safety assessment models of solution chemistry are often over-simplified.
- Solution chemistry is relevant to all national waste disposal concepts.
- It may be difficult to make conservative assumptions regarding the many coupled processes that affect, or are affected by, solution chemistry.

Alteration of Non-metallic Barriers

Most repository concepts include engineered barriers that are expected to function effectively over very long periods. Inevitably, the properties of these barriers will change (degrade) with time. One of the main drivers for degradation is chemical alteration as a result of interactions with repository waters. There is, thus, a strong coupling between the solution chemistry topics discussed above and barrier alteration.

The group felt that the alteration of long-term barriers other than waste containers (e.g., buffer, backfill) would be a good topic for a NEA workshop for the following reasons:

- Such barriers are typically required to function effectively over very long periods.
- Barrier alteration will affect radionuclide transport as well as barrier performance.
- Although canister/container/overpack corrosion is one of the most important processes in a repository because it usually determines the duration of the initial isolation period, the group decided that corrosion would not be a suitable topic for a workshop under the IGSC-EBS Project. This conclusion was reached because a wide variety of materials is used in the different national programmes, because the important corrosion processes vary amongst the different materials, and because other international projects are actively considering corrosion processes

Working Group D: Radionuclide Release and Migration

The aim of discussions within Group D was to arrive at recommendations on how the IGSC-EBS Project should make further consideration of issues related to radionuclide migration.

The discussions focused largely on radionuclide retention within the EBS and the near-field. The group recognised, however, that the materials of the EBS and the near-field also contribute to the safety of disposal systems by isolating the waste form.

The group noted that the EBS and the near-field currently receive more attention than was previously the case, possibly because the materials of the EBS and conditions within the near-field are better known than in the far-field.

The group was of the opinion that the IGSC-EBS Project would be best served by combining future consideration of geochemistry with radionuclide transport, and instead drawing a distinction between geochemical and radionuclide transport processes within the “internal” components of the

EBS and the “external” components of the EBS (Table 2). It was suggested that there were many common elements that needed to be considered when investigating the evolving geochemistry of the near-field and radionuclide transport.

Table 2. “Internal” and “External” Components of the EBS

Internal Components	External Components
Waste form	Buffer
Waste package	Backfill
	EDZ
	Seals
	Liners and ground support
	Open spaces

The group discussed whether or not it was appropriate to include the waste form as a component of the EBS. It was noted that both spent fuel and HLW can contribute significantly to disposal system safety because their properties are such that the rate of radionuclide release is limited by extremely slow dissolution. Most participants agreed, therefore, that it was appropriate to consider the waste form to be part of the EBS.

It was judged appropriate to make the distinction between the internal and external components of the EBS because of the considerable differences between the potentially significant processes that occur within the two zones. Potentially significant processes within the internal components of the EBS include corrosion, radiolysis and radionuclide dissolution. Potentially significant processes within the external components of the EBS include diffusion, advection/dispersion and sorption.

The internal EBS components can be considered as a source term for the analysis of radionuclide transport within the external EBS components.

Internal EBS Components

The group was of the opinion that the internal EBS components have, in recent years, gradually become more significant to safety assessment of various waste management concepts. This increased emphasis on the internal EBS components has resulted because:

- The internal EBS components are reasonably well defined, at least at the beginning of the assessment period.
- Understanding of the chemical processes affecting the waste form and waste package has improved.
- Enhanced computer modelling capabilities have been developed, which make it possible to conduct much more detailed analyses of the long-term evolution of the near-field.

The group felt that it is important to take account of such gradual shifts in safety assessment strategy when planning the future NEA workshops within the IGSC-EBS Project and therefore recommended the internal EBS components should form the subject of a workshop session.

Table 3 provides an overview of the issues that the group suggested should be part of a workshop session on the internal EBS components.

Table 3. **Geochemical and radionuclide transport issues relevant to the Internal EBS Components**

Priority	Issue
1	Waste form degradation and inventory
2	Evolution of conditions inside package (Chemical, Thermal, Mechanical, Hydrological)
3	Radionuclide chemistry inside package (sorption and solubility)
4	Waste package degradation
5	Radiolysis
6	Gas generation
7	Cladding degradation
8	Radionuclide release from waste package
9	Miscellaneous (e.g., criticality)
10	External conditions (e.g., groundwater chemistry)

The purpose of such a workshop session would not be to address detailed issues, as these would be more appropriately addressed in other contexts (e.g., within individual R&D projects) but, rather, to discuss how developments in the different areas might affect the performance assessment strategy.

An integrated consideration of in-package processes could also strengthen existing safety functions in performance assessments or lead to the identification of new ones. In-turn, this could enhance confidence in specific applications of the multi-barrier principle by highlighting additional redundancy within the EBS.

External EBS Components

Table 4 shows the group's appreciation of the relative importance of various processes in the assessment of the external EBS components. In Table 4, issues that the group suggested were significant to consider are shown by a +, while issues that the group suggested were of minor significance are marked with a -.

Analysis of radionuclide transport within the EBS components is, to a large extent, dependent on a sufficiently-detailed analysis of groundwater advection (flow). Flow is of importance in all components except the buffer and plugs, which are typically designed to have extremely low permeabilities. The plugs, however, may still be key in determining flows, as they have a potentially significant role to play in preventing the formation of preferential pathways through backfilled deposition tunnels.

Table 4. Processes influencing mass transport in the External EBS Components

		<i>Processes Influencing Mass Transport</i>			
		Advection	Retardation	Diffusion	Colloids
External EBS Components	Buffer	-	+	+	-
	Backfill	+	-	+	+
	EDZ	+	-	+	+
	Seals	-	+/-	+	-
	Liners and ground support	+	-	+	+
	Open spaces	+	-	+	+

Key: + = significant to consider; - = of minor importance.

Radionuclide retardation in the buffer is important to safety in many repository concepts. The relative importance depends on, for example, the thickness of the buffer and the expected lifetime of the canister. The group was of the opinion that radionuclide retardation in the other parts of the EBS system is, in principle, more difficult to rely upon and probably less significant.

The group considered that it is important to consider the effects of diffusion in all the parts of the near-field subsystem and especially in components such as the buffer where it is the only significant transport mechanism.

In most spent fuel and HLW disposal concepts, the buffer is designed to play a significant role in preventing the release of radionuclides in colloidal form by filtration. In contrast, the transport of gas through the buffer has to be considered. With the possible exception of seals, it is necessary to consider both colloid and gas transport through other parts of the disposal system.

The group discussed the potential for radionuclide release and transport calculations to assist in optimising repository design. The group concluded that results from radionuclide release and transport calculations could be used as an input to studies aimed at optimising the design and layout of the repository and the EBS. The group noted that in order to do this, the radionuclide release and transport calculations are likely to need to be supported by a detailed model of flows around the repository, so that significant flowpaths could be identified. The group noted that the importance of results from radionuclide release and transport calculations to optimisation studies would also depend on the relative significance of the far-field in the performance of the disposal system under consideration.

The group concluded that the IGSC-EBS Project should ideally focus on the exchange of information and ideas related to various principles of implementing an EBS. The group suggested that strategic considerations are easily forgotten and that detailed technical issues probably receive more

attention than is really justified. The group considered that detailed considerations about technical issues might best be resolved in other fora.

The group concluded that the topic of radionuclide release and transport would form a sensible basis for an international workshop and that it might be beneficial for the workshop to be divided so that one part would consider the internal EBS components and that a second would consider the external EBS components.

Finally the group developed a preliminary list of common issues for consideration at all future workshops within the IGSC-EBS Project (Table 5).

Table 5. **Common issues to be considered at future workshops**

Common Issues
Confidence Building
Model Simplification
Performance Assessment Modelling Strategy
Conservatism / Realism
Extrapolation over Long Time Periods
Safety Allocation
New Safety FEPs
Treatment of Evolving Conditions
Alternative Scenarios
Performance Assessment Feedback into Design Optimisation
Uncertainty/Variability/Heterogeneity

WORKSHOP CONCLUSIONS

Technical Issues

The following conclusions can be drawn from the responses to the NEA questionnaire on the EBS and the discussions at the workshop.

There is good agreement on the definition of the EBS and on its primary role: the containment and long-term minimisation/retardation of radionuclide releases. All of the radioactive management programmes include an EBS giving multiple barriers to radionuclide migration, and providing reserves of performance greater than required for compliance with safety criteria (e.g., dose or risk limits). Although the EBS plays a significant role in providing the required level of disposal system performance, there are few specific regulatory requirements of the EBS that go beyond the requirement for a robust system of multiple barriers.

There is generally good consistency amongst national EBS designs for spent fuel and HLW disposal, but less for ILW:

- For spent fuel, the main components are UO₂, mixed uranium and plutonium oxides (MOX), and other waste matrices, steel or copper-iron containers, copper, steel or Ni-alloy overpacks, and bentonite or bentonite-based buffers.
- For HLW, the main components of the EBS are a borosilicate glass matrix, steel containers / overpacks, and bentonite or bentonite-based buffers.
- For ILW, the main components of the EBS include a wide variety of waste matrices, (e.g. concrete-conditioned wastes), steel or concrete containers, and a wide variety of backfill materials, (e.g. concrete, bentonite-based materials, salt-concrete).

The greater variation in the ILW disposal concepts reflects the greater number of ILW waste streams and the wide range of different disposal sites considered in the survey.

The main functions of EBS components can be summarised as follows:

- The waste matrix is designed to provide a stable waste form that is resistant to leaching and gives slow rates of radionuclide release for the long-term (10 000 – 150 000 years).
- The container/overpack is designed to facilitate waste handling, emplacement and retrievability, and to provide containment for ~ 500 – 1 000 years or longer.
- The buffer/backfill is designed to stabilise the repository excavations and the thermo-hydro-mechanical conditions, and to provide low permeabilities and diffusivities, and long-term retardation.
- The other EBS components are designed to prevent releases via tunnels and shafts and to prevent access to the repository.

Many FEPs can influence the EBS, depending on the particular waste types and site characteristics. Potentially important FEPs include:

- Thermo-hydro-mechanical and chemical (THMC) evolution
- climate change.
- Glass dissolution/waste leaching rates.
- Container corrosion rates, container defects.
- Buffer re-saturation, swelling, and long-term alteration.
- Radionuclide transport in the buffer.
- Gas generation in container and transport through the buffer / backfill.

The need for monitoring of the repository during the active control phase is recognised in most programmes, but monitoring plans are generally in an early phase of development. Some programmes are considering monitoring phases in excess of fifty years.

Many programmes are actively involved in experiments in Underground Research Laboratories (URLs). This is an area of extensive international collaboration and there are clear links between URL experiments, laboratory experiments, process modelling and data gathering. Some programmes include URL experiments in an iterative process of performance assessment and design refinement. It is not clear, however, that URL experiments build stakeholder confidence (e.g., through demonstration).

Peer review is an important positive process that enhances confidence and should be an active part of the on-going design and assessment process. Issues identified through peer reviews in different countries include the need for:

- Demonstration of technical feasibility.
- Further R&D on particular topics.
- Balance between EBS and natural barriers.
- Consideration of uncertainties in expected performance.

Remaining design uncertainties relate mainly to issues of how to link EBS design and emplacement methods to disposal system performance. Key characterisation uncertainties include the THMC properties of buffer and backfill materials and the evolution of those properties, the effect of gas generation, the determination of parameter values for safety analysis, and the release and uptake mechanisms of ¹⁴C.

Research models are intended to justify, or demonstrate, the scientific and technical basis for simplified performance assessment models. Performance assessment models are used to develop an assessment of overall system performance for comparison with safety standards and other requirements. Uncertainties in disposal system performance can be accounted for using conservative assumptions, probabilistic techniques, deterministic sensitivity studies, and “what if?” calculations.

Performance assessment uncertainties often relate to the determination of parameter values that are representative of the large spatial scales and long time scales of interest to radioactive waste

disposal (e.g., long-term metal corrosion and glass dissolution rates, large-scale radionuclide dispersion coefficients). Other relevant performance assessment uncertainties include parameter values for thermodynamic data, geochemistry and radionuclide retardation, long-term buffer stability and spatial heterogeneity.

Lessons learnt from performance assessments include:

- Adopt a methodical, systematic and fully documented approach to repository design and optimisation.
- Simple designs and models are easier to implement and verify.
- Integrate EBS design and performance assessment activities within iterative optimisation cycles.
- Ensure, and demonstrate, design feasibility.
- Continue to build confidence in performance assessment.
- Focus on the most important issues (e.g., through the use of risk-informed approaches).

Performance assessments also suggest that EBS systems are very effective in containing radioactive wastes.

Programmatic Issues

On the third day of the workshop, it was agreed that there was strong support amongst the many countries represented for a continued international project on the EBS and that it was important to present as an overall outcome an account of how EBS design is developed, justified and implemented using state-of-the-art knowledge.

The Committee considered the format of the future programme and decided that the IGSC-EBS Project would be best served by a sequence of further workshops. It was also decided that, given the status of the different national radioactive waste management programmes, a timeframe of no more than a further four years should be envisaged for the overall duration of the project.

Given the workshop format and recommended duration of the project, the Committee concluded that a sequence of four workshops would be practicable, as follows:

Workshop 1	Design Requirements and Constraints (see Section 4.1.1).
Workshop 2	Process Issues: <ul style="list-style-type: none"> – Thermal management and analysis (see Section 4.2.1). – Alteration of non-metallic barriers and evolution of solution chemistry (see Section 4.3.1). – Radionuclide release and transport (see Section 4.4).
Workshop 3	Role of Performance Assessment and Process Models.
Workshop 4	Design Confirmation and Demonstration (see Section 4.1.2).

This sequence of workshops will lead the IGSC-EBS Project through an optimisation cycle of the type discussed at the workshop (e.g., Figure 1). The aims of the proposed workshops are summarised in Table 6.

Table 6. Aims of Proposed Future EBS Project Workshops

Workshop Topic		Workshop Aims
1	Design Requirements and Constraints	<ul style="list-style-type: none"> • To state the design requirements for various facilities and identify their basis, including the evolution of these requirements. • To promote common understanding of the requirements, and of methods for linking between societal and stakeholder requirements to detailed design concepts and decisions. • To share ideas and experiences on working with challenging requirements and constraints. • To better understand the basis for differences in national EBS designs.
2	Process Issues	<ul style="list-style-type: none"> • To share ideas and experiences on the consideration of key scientific and technical issues, and to identify their implications for both performance assessment (and ultimately the safety case) and EBS design.
3	Role of Performance Assessment and Process Models	<ul style="list-style-type: none"> • To consider how performance assessment and process models can be used to i) inform the choice of appropriate designs, e.g., through the consideration of design alternatives; and ii) to identify key design and research and development priorities. • To demonstrate the use of models in the approach to design optimisation for deep geological disposal. • To consider the development of guidelines on the level of detail required in modelling to ensure appropriate input to EBS design and optimisation.
4	Design Confirmation and Demonstration	<ul style="list-style-type: none"> • To examine methods for demonstrating that design requirements have been met in a regulatory environment, and considering the practicalities of implementing design concepts. • To consider a range of confidence-building methods, including theoretical studies, modelling, accelerated testing, URL/prototype tests, natural/man-made analogues and <i>in-situ</i> monitoring.

At the end, the idea of repeating the exercise that was done for the establishment of the state-of-the art report at the end of the project was agreed as a good means of measuring progress.

REFERENCES

Bennett, D.G., Papenguth, H.W., Chu, M.S.Y., Galson, D.A., Duerden, S.L. and Matthews, M. (1998) *International Workshop on the Uses of Backfill in Nuclear Waste Repositories*, Carlsbad, New Mexico, USA, May 1998. US Department of Energy / Environment Agency R&D Technical Report P178. Bristol: Environment Agency.

NEA-EC (2003) *Engineered Barrier Systems and the Safety of Deep Geological Repositories, State-of-the-art Report*, EUR 19964 EN.; Paris 2003 , ISBN 92-64-18498-8

JNC (2000) *H12: Project to Establish the Scientific and Technical Basis for HLW Disposal in Japan, Supporting Report 2*, JNC TN1410 2000-003.

POSIVA (2000) *Disposal of Spent Fuel in Olkiluoto Bedrock, Programme for Research Development and Technical Design for the Pre-Construction Phase*. Posiva Oy Report No. 2000-14, Helsinki, Finland.

APPENDIX A

WORKSHOP AGENDA

DAY 1 Wednesday 25 September 2002**PLENARY SESSION**

09:00 Welcome Addresses, Sylvie Voinis (NEA), Henning von Maravic (EC), Alan Hooper (Nirex)

09:20 Introduction: Scope and Objectives of the Workshop, and Explanation of the IGSC-EBS Project, Hiroyuki Umeki (NUMO)

09:45 Compilation of Answers to the NEA Questionnaire. David Bennett, (GSL)

10:10 Coffee break

10:30 SESSION I: EBS FUNCTION, DESIGN, AND CHARACTERISATION

Chairperson: Hiroyuki Umeki (NUMO), Rapporteur: David Bennett (GSL)

10:30 Managing Design Requirements in Crystalline Rock, Timo Äikäs (POSIVA)

11:00 Managing Design Requirements in Clay Media, Frederic Plas (Andra)

11:30 Design Requirements Salt Media, Closure Concept for the Morsleben LLW Repository – Design of Drift Seals in a Former Salt Mine, Nina Müller-Hoeppe (DBE), Ralf Mauke (BFS)

12:00 Modelling Issues on the CROP Project, Roland Pusch (GEODEVELOPMENT AB)

12:30 Lunch break

14:00 SESSION II: EBS MODELLING AND PERFORMANCE ASSESSMENT

Chairperson: Patrik Sellin (SKB), Rapporteur: David Bennett (GSL)

14:00 The Role of the EBS in Demonstrating Post-Closure Safety of the Proposed Yucca Mountain Repository, Robert J. MacKinnon (SNL), Frank M. Wong and Abraham Van Luik (USDOE)

14:30 EBS Modelling and Performance Assessment in SAFIR 2: Approaches, Conclusions and Forthcoming Work, Xavier Sillen and dJan Marivoet (SCK•CEN), Jean-Paul Boyazis, Philippe Lalieux, Peter De Preter and Johan Bel (ONDRAF/NIRAS)

15:00 EBS Modelling and Performance Assessment from H12: Results, Conclusions and Future Priorities, Hiroyuki Umeki and Hiroyoshi Ueda (NUMO), Masao Shiotsuki (JNC)

16:00 On-Going Activities of the EC Project BENIPA, Jesus Alonso (ENRESA)

16:30 Conclusion, Discussion, Introduction to Working Groups Sessions, Patrik Sellin (SKB), David Bennett (GSL).

17:30 End of Day 1

DAY 2 Thursday 26 September 2002

WORKING GROUP SESSIONS

- 09:00 - 10:30 Parallel Working Groups Sessions
10:30 - 11:00 Coffee break
11:00 - 12:30 Parallel Working Groups Sessions (cont'd)
12:30 - 14:00 Lunch break
14:00 - 15:30 Parallel Working Groups Sessions (cont'd)
15:30 - 16:00 Coffee break
16:00 - 17:30 Parallel Working Groups Sessions (cont'd)
17:30 End of Day 2

DAY 3 Friday 27 SEPTEMBER 2002

CONTINUATION OF WORKING GROUP SESSIONS

- 08:30 - 10:30 Parallel Working Groups Sessions (cont'd)
10:30 Coffee break
11:00 ROUND-UP PLENARY SESSION
 Chairperson: Alan Hooper (Nirex), Rapporteur: David Bennett (GSL)
11:00 - 12:30 Reports from Working Groups A, B, C and D
12:30 - 14:00 Lunch break
14:00 Synthesis of the Workshop and Recommendations for Further Actions
14:30 Final Discussion and Closing of the Round-up Plenary Session
15:00 End of the Workshop

APPENDIX B

PAPERS PRESENTED TO THE WORKSHOP

MANAGING DESIGN REQUIREMENTS FOR A REPOSITORY IN CRYSTALLINE ROCK

Timo Äikäs
Posiva Oy, Finland

Posiva is preparing the geological disposal of spent nuclear fuel generated in Finland. The Olkiluoto site in Eurajoki in Western Finland was selected for disposal in 2001 based on site selection research programme carried out since 1983. The disposal concept as a reference in planning the geological disposal and in decision making has been the KBS-3 type design. This concept comprises a system of natural and engineered barriers. The characteristics of the system are long-lived copper-iron canister and the bentonite buffer which surrounds the canister. These packages are placed in deposition rooms at sufficient depth in crystalline bedrock. Deposition rooms and access routes are backfilled with suitable material to make possible the favourable conditions in the geosphere to return as much as possible to the those before the construction the repository.

What are the system requirements of a disposal system? What shall the system fulfil, how well, how much and when? The answer is that the system shall isolate the waste from organic environment and retard the transport of radionuclides towards the biosphere This shall be possible even in the distant future so that radioactive waste does not appear in unacceptable quantities in the environment. The requirements on isolation and retardation are based in Finland (and also elsewhere) on laws and/or other statutes and internationally recognised recommendations. Very common are also requirements on tendency towards redundancy when designing the solution for disposal system. These “top” requirements on the system are basically similar in spite of the geological environment.

KBS-3 or any other disposal system can be divided in sub-systems and components. The functions these shall fulfil are very much the same in all systems designed so far. It can be simplified that canister and buffer as sub-systems, for example, have to fulfil very similar requirements practically in all host rocks where groundwater is present. Due to the different geological environments and processes prevailing (or anticipated) the design solutions only become different.

Requirements basically integrate the work of safety and performance assessments, characterisation of geological environment and engineering. Safety requirements and assessments tell and evaluate what the system shall fulfil but they do not say in detail how and with which level of confidence the requirements shall be fulfilled. Performance assessment in principle should give answers to “how well”, what is adequate. The properties and processes in the geological environment are the basis for developing functional requirements for sub-systems and components, as well as, effective design base. Engineering will design the solutions for engineered barriers and verifies these against the requirements. The verification of the design solution cannot, however, be always be straightforward testing but have to be sometimes based on indirect scientific evidence like seeking confidence in corrosion resistance of copper canister. This process is iterative and can also be used effectively for optimisation of the disposal system.

Management of requirements is a process in which the requirements are defined “top down”, starting from legislation and other stakeholder needs like owners’ needs. These needs establish the uppermost hierarchy of requirements which is difficult to change. The needs are transformed to precise requirements to define what the system shall do. Functional requirements of sub-systems and components are developed against the upper hierarchy requirements, which describe basically their barrier function. In the management system each lower level requirement, as well as, design basis can be traced to other requirements. This linking provides traceability throughout the work. Missing requirements, contradictory or unclear requirements etc. call for research activities. Each design solution developed has to be assessed as regards to ability to predict its behaviour as part of the disposal system. If the prediction is not possible the design solution is not feasible. In the Figure 1 an intergrated work process for developing a disposal system is presented.

Figure 1. Development process for disposal system

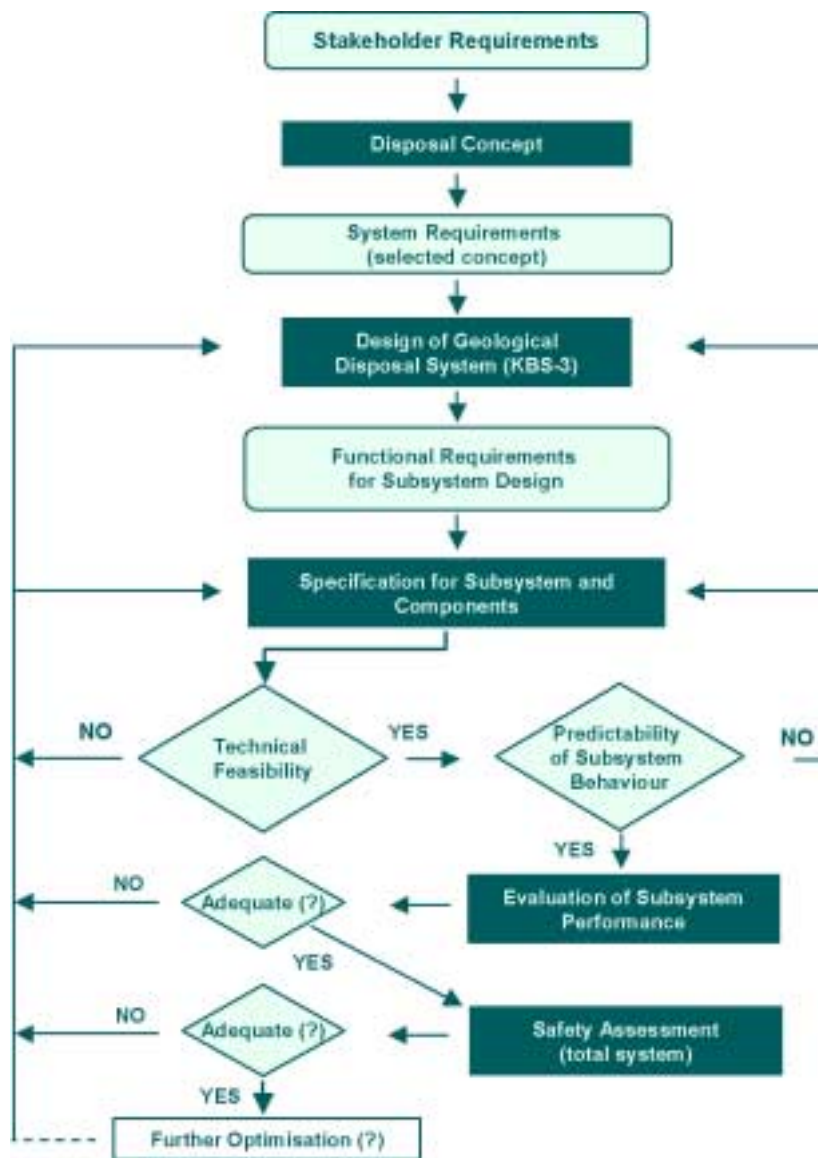

MANAGING DESIGN REQUIREMENTS OF THE FRENCH HLLW PROGRAMME IN CLAY MEDIA

Jean-Michel Hoorelbeke, Stefan Mayer and Frédéric Plas
Andra, France

1. Introduction

Design requirements of the man made components of the repository, including the Engineered Barrier System (EBS) are established based on a list of considerations. Where applicable, these design requirements address general and EBS specific regulatory considerations, in an effort to provide technologically feasible and economically viable solutions. They take into account the interactions between the construction and operation of the EBS and the natural environment. They respond to the specific attributes of waste types. They evolve taking into consideration lessons learnt from prior safety assessments, peer review comments and regulatory authority requirements and recommendations.

Managing design requirements is assisted by the compilation of a set of comprehensive Specifications of Functional and Technical Requirements (SFTR). These are issued taking into account all possible sources of requirements and constraints imposed on the design, construction, operation, and long term safety of a repository. They include both specific input data as well as requirements that are translated into prescriptions for the design. The SFTR are established based on current knowledge and uncertainties.

Managing design requirements is an iterative process, which must also take into account the potential evolution of knowledge, design options, regulatory or other “high-level” requirements, and construction and operation procedures. For example, reducing uncertainty about the dissolution model and rate of vitrified waste may allow to relax design requirements on waste package (WP) lifetime. A sensitivity analysis identifying those parameters most important to performance may focus attention on associated design requirements. Requiring the implementation of an observation program during repository operation adds complexity, which may translate into additional modeling needs and design requirements. Using construction and operation procedures that minimize any negative impact on natural barrier performance may allow to relax those design requirements intended to compensate for such an impact. Any such evolution having an implication on design requirements is tracked in the SFTR.

Among other things, the SFTR thus represent an important link between design requirements and scientific understanding, operational and long term safety considerations, and performance assessment. An initial understanding of processes and parameters important to design is gained from the phenomenological analysis of specific aspects of the repository and their evolution with time. The resulting estimates of temperature, pressure, etc., evolutions contribute to the first set of design requirements. As design choices are developed and known to some detail, related process models may

yield more accurate predictions of parameter evolutions, which may translate into modifications of design specifications.

The French program on geological disposal is carried out in the framework of the 1991 Act on long term waste management. A repository architecture has been designed to assess the feasibility of geological disposal by 2005. The separation into different zones, each dedicated to a specific waste category, the centralized access shafts and tunnels, and the modular structure of each zone are shown in Figure 1. It is noted that this preliminary architecture, while responding to specified design requirements, is not necessarily optimized taking into account all technical and economical considerations. Consequently, it does not anticipate the final solutions that might be industrialised if construction of such a facility is decided in the future.

Figure 1. Overall architecture of HLW disposal concept (not to scale)

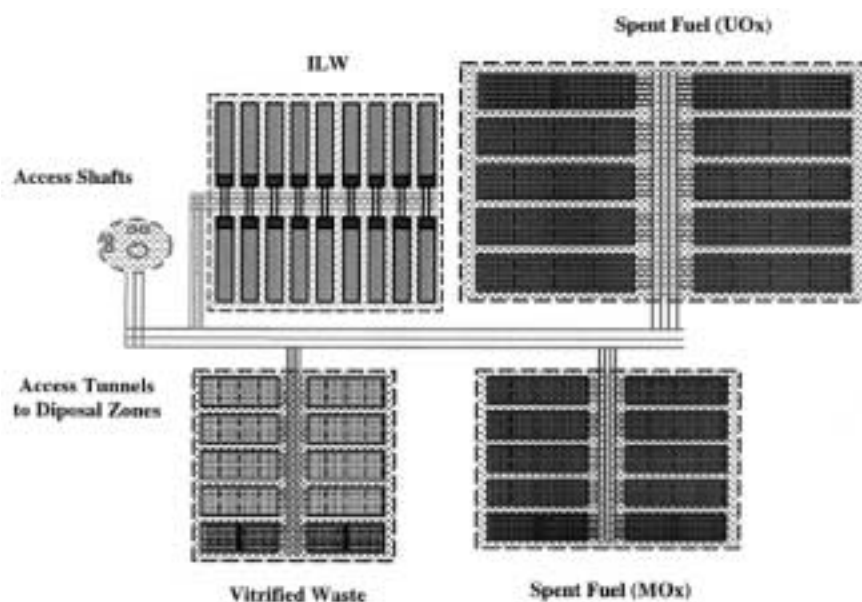

2. Regulatory implications on design requirements

The French basic safety rule recommends selecting a site having favorable characteristics, such as long term geologic stability, low permeability, favorable geochemistry and the mechanical stability allowing construction of and operation in EBS. Recently, the need to take into account reversibility and the associated observation needs has also been reemphasized.

The rule provides for an iterative approach between knowledge acquisition, design evolution and safety analysis. This allows for a gradual development and refinement of a list of requirements in the SFTR and of the performance evaluation of the components of the disposal system developed to fulfill these requirements.

The rule also requires making an overall safety case, demonstrating that dose remains below 0.25 mSv/yr in normal evolution during a 10^4 year period, using a multiple barrier concept. This general legal requirement constrains the EBS design to such options whose evolution (degradation, corrosion...) and interaction with the waste and natural environment can be reasonably modeled. At

greater time scales, dose estimates are to be provided and compared to a 0.25 mSv/yr reference value. The emphasis is shifted on demonstrating the performance of the geosphere, which must be capable by itself to meet with the radioprotection objective, taking into account the EBS tunnel and shaft sealing.

All legal, regulatory and governmental requirements were analysed and their implication on specific design requirements considered while developing the SFTR. Some of the general requirements (e.g. dose limit) do not have specific implications on the design requirements, but are translated into the latter after an iterative process of designing, evaluating overall performance, and finding the need for specific design modifications.

3. Design requirements, program criteria and method to choose

Design requirements evolve both gradually - for example as new knowledge is gained or as the implications of, say, operational constraints are better understood – and substantially – for example following a program review focused on making major design choices. In preparation of the 2005 feasibility report, Andra made design choices in 2002, aiming to focus ongoing studies on a design that respects four guiding principles: simplicity, robustness, reversibility and efficiency.

A systematic method to choose viable design concepts based on these guiding principles was used. The simplicity of candidate design options was evaluated considering, among other things, ease of construction, operation, safety, and sealing. Their robustness was evaluated within the context of current knowledge on THMC evolution and considering potential accidents during operational phase (fire, dropping WP during transport, criticality) and post closure (criticality, human intrusion). Reversibility was evaluated considering the flexibility of operational choices, including retrieval of WPs, the ability to observe (monitor) and enhance knowledge, and the ease of implementing knowledge-based management decisions. Efficiency was measured combining the overall repository performance, preservation of natural barrier properties, footprint and estimated cost.

An example of a design concept respecting these criteria for the disposal of vitrified waste is shown in Figure 2. Design requirements related to the emplacement operation and to the reversible waste management suggest the use of a guide tube. Control of a diffusive transport environment suggests the use of a swelling clay based buffer zone surrounding the guide tube. Design requirements related to limiting temperatures to sub-boiling levels suggest the use of spacings between WPs.

Figure 2. Design concept – Disposal cell for vitrified waste

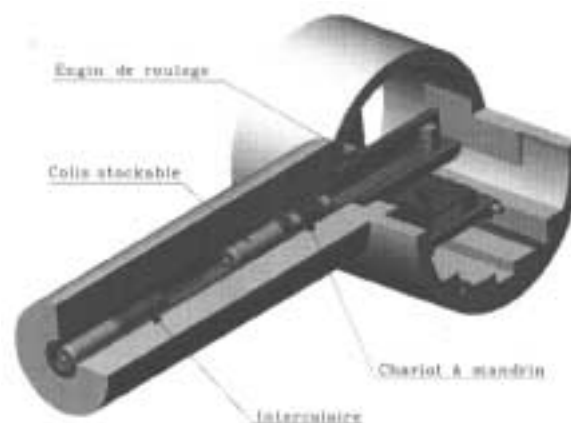

4. Design requirements and site specific considerations

The design of the EBS is driven by the needs mainly to minimize impact on the favorable barrier properties of the clay host rock and waste packaging, to restore and/or alleviate the detrimental impact of the EDZ, and to control the evolution of environmental conditions in the near field.

The “Meuse/Haute Marne” clay site currently studied for a potential HLLW repository (see Figure 3) offers favorable conditions for radionuclide (RN) containment. The site has been geologically stable for a period on the order of 10^8 yrs, with no significant seismic activity and an absence of major faults. The undisturbed, reducing clay environment has low permeability without any known or anticipated preferential transport paths, suggesting a diffusion dominated transport mode with high sorption. These favorable properties translate into a transport time scale on the order of 10^5 yrs across a vertical layer thickness of 50 m at 500 m depth.

Figure 3. Localisation and Geological data of the “Meuse / Haute Marne” site

a) Geological map of the Parisian Basin with the “Meuse/Haute Marne” clay site (URL location in red)

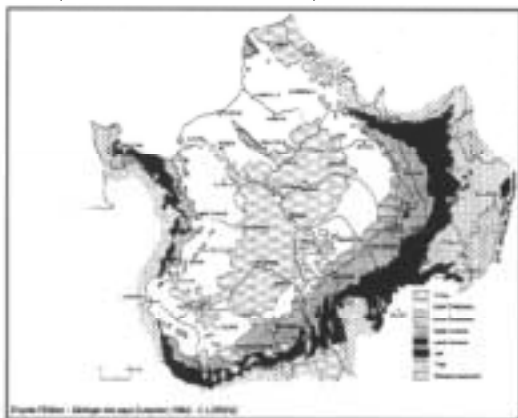

b) Geological 3D diagram of the “Meuse/Haute Marne” clay site (URL location in red)

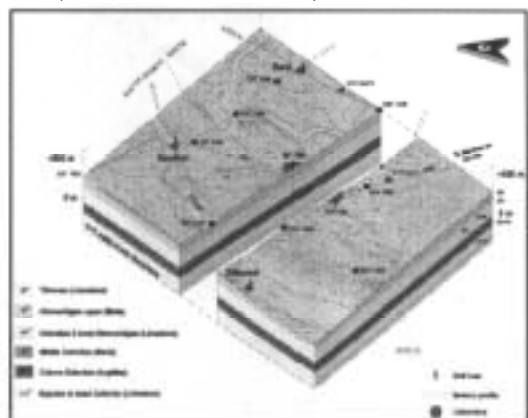

c) Geological cross sections of the “Meuse/Haute Marne” site

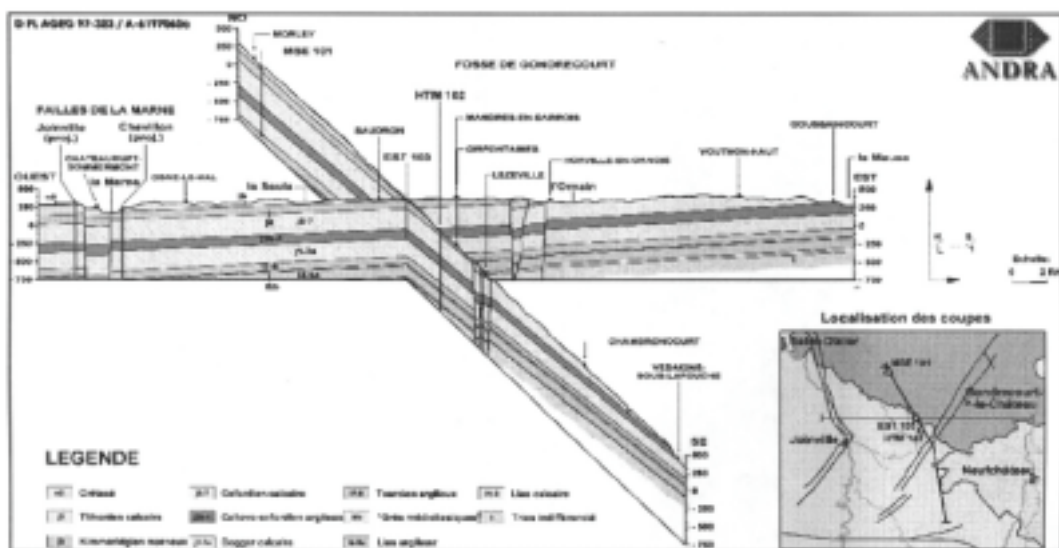

Design requirements are developed to maintain diffusive transport properties around WPs and to prevent the development of a convective transfer zone through disposal and access tunnels and/or the EDZ. As formalised in the SFTR, design is to allow for a construction method that minimises the EDZ. Before backfilling and sealing: a) the role of the tunnel support is to prevent convergence of the clay host rock exceeding its plastic deformation limits, in order to prevent further growth of the EDZ, and b) seal areas are to withstand the lithostatic pressure, in order to prevent long-term convergence of the host rock and the potential creation of an advective transport mode. To alleviate the influence of the EDZ on the near-field transport properties, a swelling clay based buffer can be designed around respectively the C-waste and the spent fuel disposal packages.

5. Implications of waste (incl. Spent fuel) properties on the design requirements

A significant variety of HLLW types (incl. spent fuel) must be taken into account in the feasibility study. To assist repository design, these were inventoried and categorised. Three main categories are distinguished: B-type waste (ILW, mostly technological, compacted, and effluent by product waste, for example hulls and end-pieces; 8 major types are identified), C-type waste (various vitrified waste types ; 5 major types are identified), and spent fuel (uranium oxide and mixed uranium and plutonium oxide).

To allow for some flexibility in handling future evolutions of the inventory intended for the repository, the architecture is partitioned into four distinct zones separated by a specified minimum distance (see Figure 1). Each zone is dedicated to a waste category. Within each zone, waste is disposed into separate modules, to reduce the potential consequences of an intrusive event. Specific design requirements are developed for each of these zones, and possibly for some of the modules, taking into account the interaction between the waste considered, the EBS design and materials used, near-field, and the need to demonstrate a safety case based on the evolution within each zone.

Design requirements are influenced by WP dimensions, waste form, inventory, surface radiation levels, heat generation, gas generation, and chemistry. The SFTR contains dedicated sections for each of the main waste types, to account for this range of waste type properties and to translate specific needs into waste-specific design requirements. For example, spent fuel generates the most significant thermal phase, and design requirements take into account the implications on near-field properties. Figure 4 illustrates the design concept currently considered. Allowable WP density is computed to respect the design requirement of sub-boiling temperatures in the disposal zone. The emplacement of several waste packages in a single disposal cell, separated by an adequate spacing, is also considered.

Figure 4. Design concept – Disposal cell for spent fuel

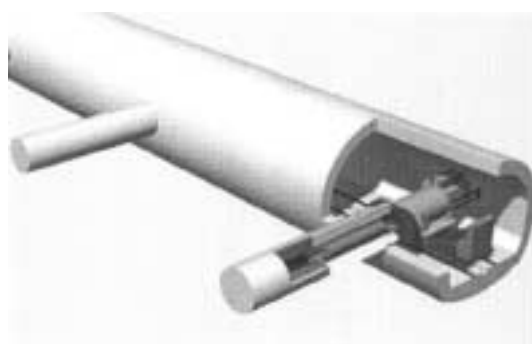

Some of the B-type waste (ILW) generate hydrogen through hydrolysis processes. Disposal cell design requirements thus include adequate ventilation and other fire and explosion safety features. Disposal package container design requirements include a gas permeability that is sufficiently high to prevent internal pressure build up. The release of hydrogen from waste may be accompanied by gaseous RN release, and design requirements include corresponding containment and radiation protection measures.

6. Design requirements and the demonstration of the safety case

Demonstrating the safety case requires, among other things, that chemical and physical processes are well understood and that models are supported by sufficient evidence. Such evidence (experimental results) is usually available for ambient environmental conditions and, to a lesser extent, for a number of disturbed conditions (increased temperature, ...). Outside of such a defensible range, the modeler is required to deal with an increase in uncertainty. The EBS design is required to contribute to the safety case by, among other things, contributing to a control of the environmental parameters. Corresponding design requirements are thus driven by a need to compensate for limited scientific knowledge.

The SFTR includes all such “limit of knowledge” design requirements. For example, because the evolution of clay properties and geochemistry are not well understood at above boiling conditions, the overall repository architecture and emplacement in tunnels is optimised to ensure sub-boiling temperatures. A number of physical and chemical properties are not well understood at temperatures above 50 to 80°C. For instance, there is a lack of knowledge on waste dissolution and radionuclide sorption properties at elevated temperatures. Due to the very long thermal periods for spent fuel (see Figure 5), design requirements, constrained by the need to demonstrate release and transport properties, dictate that WPs and their overpack prevent any release prior to on the order of 10⁰000 years. These requirements may evolve if relevant physical and chemical processes are better understood at elevated temperatures.

Figure 5. Evolution of temperatures near UOx and MOx spent fuel waste packages

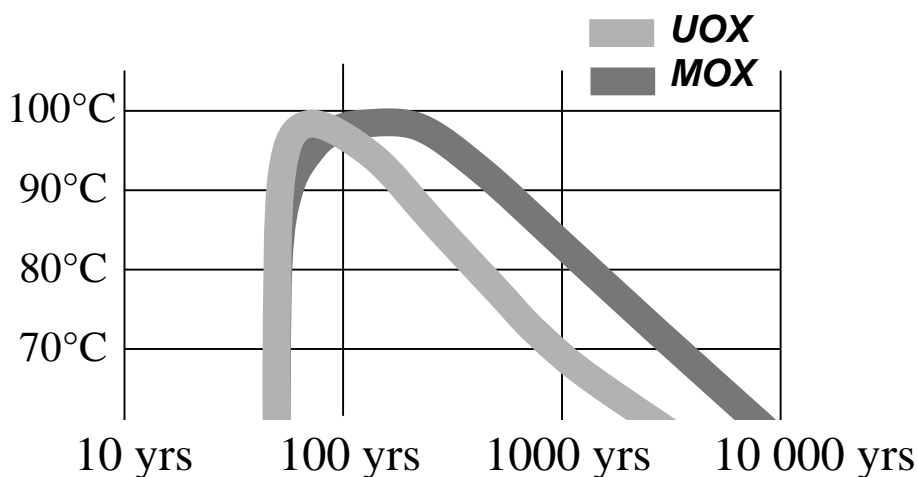

Design requirements for vitrified waste are also strongly influenced by the temperature evolution at the waste form, in the EBS and in the near-field. The waste form release rate increases with temperature. Therefore, the WP design is required to prevent any release for on the order of 10^3 years, a period which allows for adequate cooling of the waste and a corresponding reduction in release rates.

7. Conclusion

Managing design requirements is an iterative process, taking into account the current status as well as managing the evolution of scientific knowledge, understanding of long-term safety, regulatory or other high-level requirements, design, and construction and operation procedures. It has strong ties with two knowledge and data management systems: as pertaining to scientific knowledge and modeling results, on one hand, and to repository configuration and design options, on the other.

The set of SFTR are understood as a working tool within the iterative process between evolving knowledge and evolving design options. They also represent a list of criteria that will serve to evaluate the compliance of repository design and construction with all requirements. As such, they are one of several tools to evaluate the operational and long term safety of the repository.

CLOSURE CONCEPT FOR THE MORSLEBEN LLW REPOSITORY FOR RADIOACTIVE WASTE DESIGN OF DRIFT SEALS IN A FORMER SALT MINE

Ralf Mauke, Jürgen Wollrath

Federal Office for Radiation Protection (BfS, Germany)

Nina Müller-Hoeppe

Deutsche Gesellschaft zum Bau und Betrieb von Endlagern für Abfallstoffe (DBE, Germany)

1. Introduction

The rock salt and potash mine Bartensleben was selected in 1970 to serve as a repository for low- and intermediate-level radioactive waste (LILW). Located close to the village of Morsleben approximately 100 km east of Hanover the facility was named “Morsleben Repository for Radioactive Waste (Endlager für radioaktive Abfälle Morsleben – ERAM)”. It was designed, constructed and commissioned between 1972–78. Following studies and the successful demonstration of the disposal technologies used, the operating licence was granted in 1981. The disposal of waste was terminated on September 28, 1998. The license for operating the repository originates from the former German Democratic Republic and does not include the license for the closure of the repository. Therefore, according to the Atomic Energy Act (Atomgesetz, AtG) a license application for the closure of the repository has to be prepared by the Federal Office for Radiation Protection (BfS) who became the responsible operator of the repository after the reunification of Germany in 1990. Presently, BfS plans a closure concept, which matches the long-term performance requirements. It comprises backfilling and sealing of the underground excavations with salt concretes. In the closure concept drift seals as components of an engineered barrier system (EBS) play an important role to guarantee the long-term safety of the repository.

2. Local geology

The ERAM is located in the structure of the Aller valley zone, named after the small river Aller, covering an area of approximately 50 km². Tectonically it is a fault structure, due to extension tectonics, which separates the Lappwald block and the Weferlinger Triassic block. Into the fault zone Permian evaporate strata intruded and accumulated to a plug forming the now existing salt structure. The top of the salt leaching surface is at 140 m below mean sea level and the thickness of the salt body varies between 380 m and 500 m.

The evaporate rocks belong to the Upper Permian Zechstein strata which had been developed in the Central European Basin over an area of more than 700 000 km². The total salt volume amounts to 153 000 km³. The Zechstein is subdivided into different cycles of salt accumulation. Each cycle starts with terrigenous, generally clayey deposits (e.g. “salt clays”) overlain by carbonatic and sulfate (anhydrite) rocks followed by a sequence represented by rock salt and in places, by potash salt, capped

by thin rock salt and anhydrite layers. In the ERAM layers of the Staßfurt- (z2), Leine- (z3), and Aller-cycle (z4) are present. The older salt layers were found by exploratory drillings.

The salt body is characterised by an intensive folding of the layers and a high amount of anhydrite rocks, such as the main anhydrite (“Hauptanhydrit”) of the Leine-formation (z3HA). The stiff anhydrite layers, broken into blocks during the flow of the plastic salt strata stabilise the salt structure internally and lead to low convergence of mine excavations. Another feature of the deposit is the occurrence of potash seams which mainly are carnallite and kiseritic hartsalz. In general, the evaporite layers and the tectonic elements, such as folds, follow the border of the structure.

The salt leaching surface forms a more or less flat plane at a depth of approximately 140 m below mean sea level. The leaching surface displays a certain relief with depressions in some places with a proved maximum of approximately 175 m below mean sea level. The overlying cap rock has a very low hydraulic conductivity and isolates the salt structure from the aquifer system in the overlying upper Cretaceous rocks. The aquifer is overlain by unconsolidated or semi-consolidated glacial sediments. In addition, the surface cover is provided mostly by Quaternary sediments.

Figure 1. Local geology of the ERAM. Cross-section perpendicular to the Aller valley

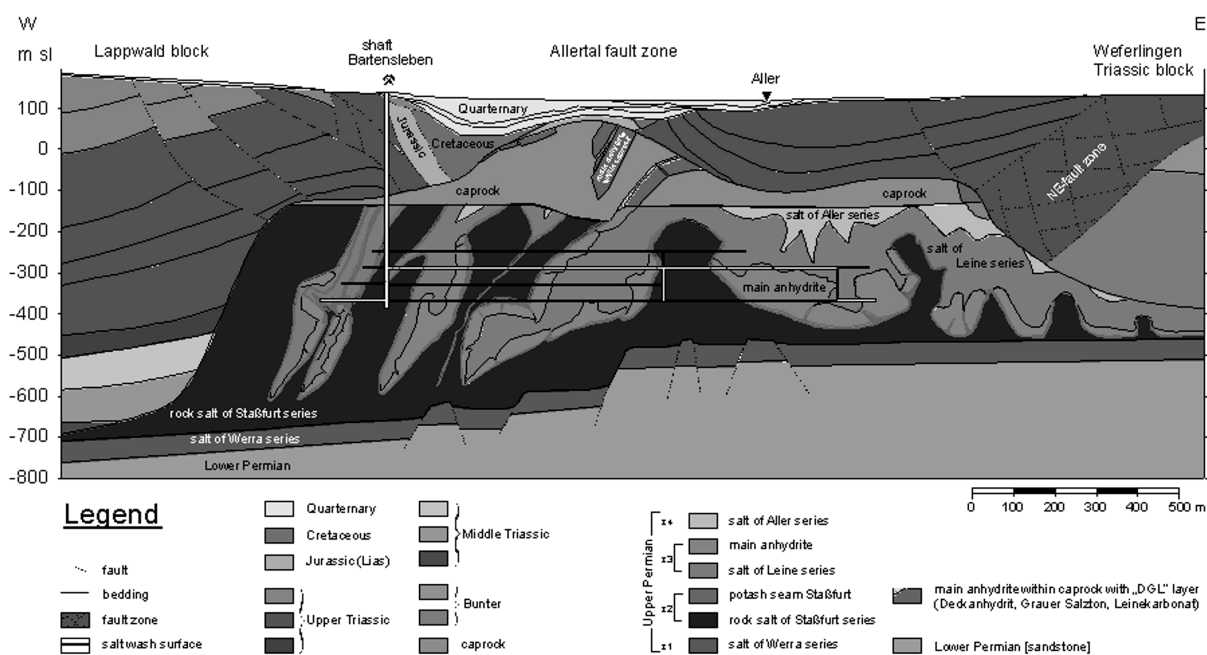

3. Mining conditions and radioactive inventory

The ERAM is a twin-mine consisting of the concessions Marie and Bartensleben. It is 5.6 km long and has a maximum width of 1.4 km. There are two access routes to the underground excavations. The shaft "Bartensleben" is the main shaft used for men ride and material transport. The auxiliary shaft Marie is located approximately 1.6 km to the north-west. The shafts provide access to a widespread system of drifts, cavities and blind shafts between 320 m and 630 m below the ground surface. The 525 m deep Bartensleben shaft connects four main levels at depths of 326 m, 426 m, 466 m and 506 m below ground surface and the 520 m deep Marie shaft connects two main levels.

Prior to waste disposal rock salt and potash mining went on at the site for several decades. Thus, most of the mining openings are a result of salt production activities. The cavities made by chamber working have dimensions up to 100 m in length, in a few cases up to 200 m, and 30 m in width and in height. An important difference between the mining fields is that Bartensleben produced much more rock salt (approx. 5 million m³) in relation to potash salt (approx. 0.7 million m³), whereas in the Marie mine the exploited volume of potash salt (1.4 million m³) is much higher than the volume of the produced rock salt (0.7 million m³). Including shafts, drifts and infrastructure rooms the overall volume of the cavities amounts to more than 8 million m³ (Figure 2), of which more than 2 million m³ have been backfilled mainly using crushed salt.

Figure 2. Overview of the underground structure and mining fields

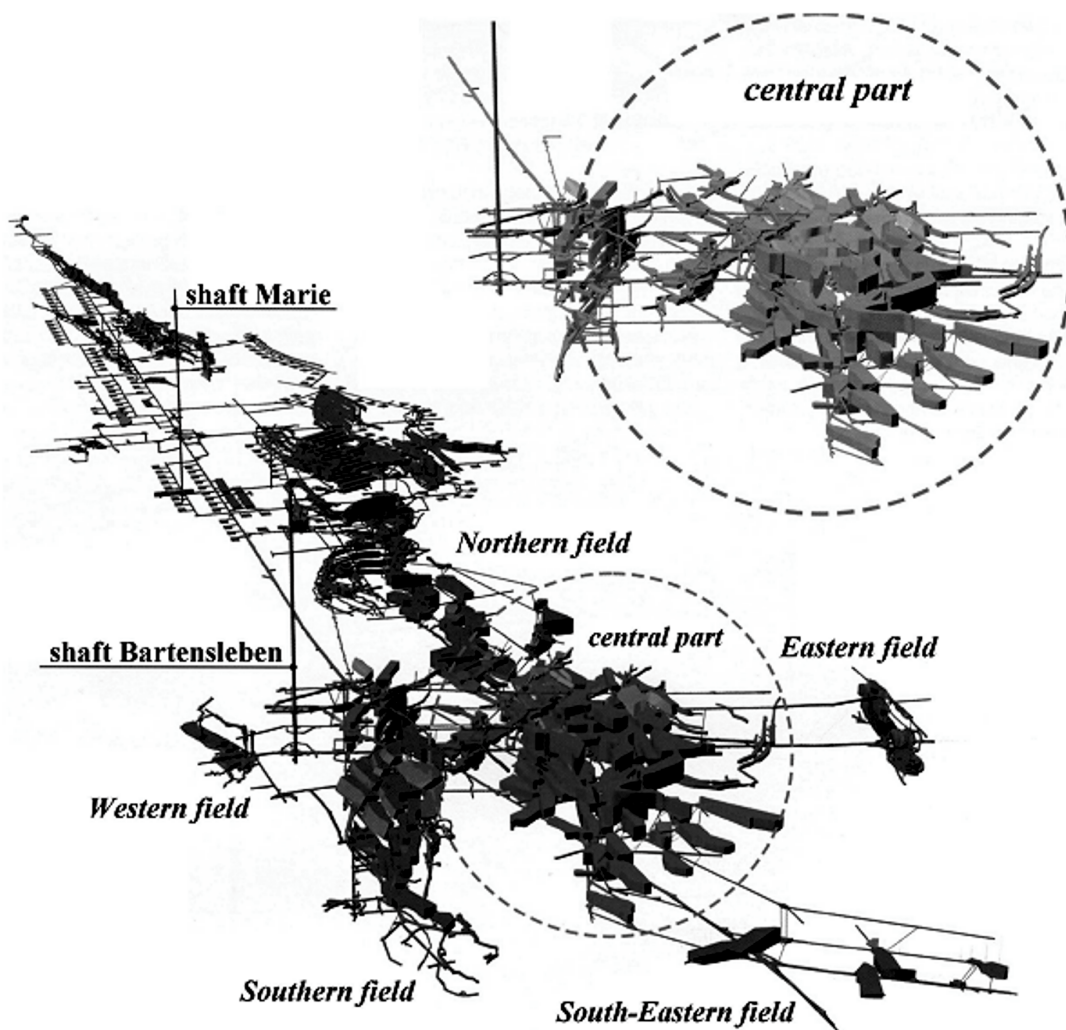

The disposal rooms are located in the periphery of the Bartensleben claim, above all in the western, southern and eastern fields, Figure 2. Very low amounts of waste are emplaced in the central part and the northern field. The waste is stored on the 4th level and the 5a sublevel. The activity of the waste and its volume is given in Table 1.

Table 1. Volume and activities of disposed waste

Disposal area	Waste volume [m ³]	Activities [Bq]
Western field	18 637	2.3·10 ¹³
Southern field	10 119	8.2·10 ¹³
Eastern field	6 139	1.1·10 ¹³
Northern field/central part	1 858	4.1·10 ¹²

The waste originated from the operation of nuclear power plants, decommissioning and applications of radioisotopes in research, industry, and medicine. Solids and liquids as well as sealed sources were disposed of. Drum piling and dumping, as well as stacking of drums and cylindrical concrete containers were used as disposal technologies for solid waste. The liquids, mixed underground with hydraulic binders, were pumped into the storage cavities and solidified there. Altogether, a volume of about 36 800 m³ has been disposed of (approx. 28 500 m³ solids and 8 300 m³ liquids).

4. Potential pathways of fluids

Concerning the safety of a repository for radioactive waste the investigation of salt solutions as well as the detection of potential pathways is essential because brines are an effective leaching agent and have to be considered as the major transport medium of mobilised radioactive substances. Moreover, the brines may act as a corrosive medium of the binding agent of the concrete and may cause corrosion of metals. Under anaerobic conditions, the latter process results in a generation of hydrogen.

Figure 3. Host rock, mine openings and potential pathway of fluids

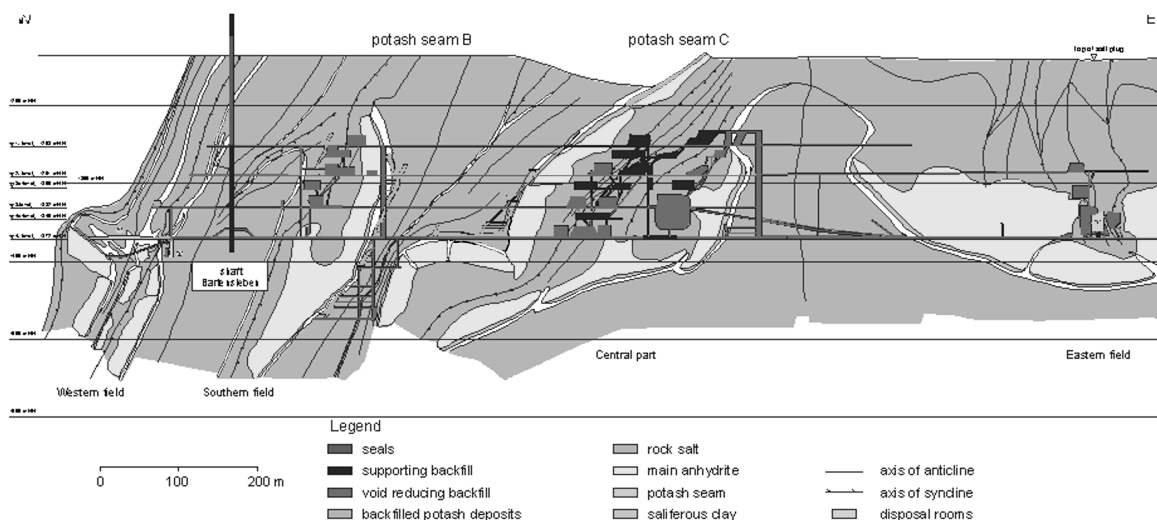

With regard to repository closure it is necessary to distinguish between closed reservoirs of brines trapped in rocks and inflows connected to the groundwater system. The precise investigation of active brine occurrences as well as of potential pathways is important with respect to brine inflows

during the post-closure phase and the outflow of contaminated solutions. Besides the shafts potential pathways may occur along potash seams and enclaves of competent rock with a tendency to brittle failure, e.g. anhydrite blocks.

Recently active brine inflows into the mine openings have been low. Thus, one location is situated far from the disposal areas in the Marie mine and has an inflow rate of about 10 m³/a. A dropping location with an inflow rate of about 1 m³/a is situated on the first level of the central part of the Bartensleben mine. The chemical composition of the NaCl-saturated, Mg-rich solutions have been nearly constant and prove a contact with potash salts.

Concerning potential pathways special attention has to be paid to the main anhydrite (z3HA) and the overlain potash seam C. These geological units connect the cap rock to the excavation disturbed zone of the mine openings of the central part and may act as future pathways for fluids (Figure 3).

5. Closure concept and long-term safety objectives

The “Safety Criteria for the Disposal of Radioactive Waste in a Mine” qualitatively specify measures to be taken in order to agree with the long-term safety objectives of disposal. The long-term safety objectives regarded in general mainly focus on radiological safety. i.e.:

- protecting the biosphere against harmful effects of radionuclide release;
- avoiding criticality.

In the case of the ERAM, however, due to the large void volume classical conventional long-term safety objectives such as:

- limiting ground surface subsidence;
- protecting groundwater against release of conventional pollutants.

have to be considered additionally [1]. The safety assessments distinguish two main groups of scenarios [2]. In the first group of scenarios no fluid inflow into the mine openings does occur (dry repository condition) whereas in the second group of scenarios fluids enter the mine openings and may get into contact with the radioactive waste (wet repository condition).

The closure concept, which is presently being evaluated by the licensing authority, relies on a comprehensive backfilling of all mine openings (extensive backfill closure concept). The mine openings are backfilled with salt concretes to stabilise the underground structure, to limit leaching processes in case of unsaturated brine inflow and to seal the disposal areas.

According to safety measures agreed upon internationally, the multi-barrier concept is included in the closure concept, i.e. safety is not considered to be guaranteed only by one barrier, i.e. the geological formation. In general a multi-barrier system may include the waste form, the packaging as well as backfilling and sealing measures. By this means, the waste will be isolated by a system of parallel or interlocking natural and technical barriers.

In the case of the ERAM tight shaft seals are planned as to limit the volumetric flow rate of brine passing the shafts to a negligible extent. Besides the comprehensive backfill important components of the closure concept, however, the drift seals separate the disposal areas (eastern, western and southern field) from the residual mine openings and the potential pathways to the

groundwater system existing there, e.g. the main anhydrite (z3HA) and potash seam C in the central part of the Bartensleben mine. One remarkable safety relevant property of the ERAM is the intact geological rock salt barrier surrounding the disposal areas, whose long-term integrity has already been shown. For this reason the access drifts are the relevant potential pathways for radionuclide release from the disposal areas and, thus, the drift seals are an engineered barrier of major importance.

5.1 *Plan of backfilling*

When planning the closure concept every excavation was assigned to one of four backfilling categories [3]. Most important is category I including cavities requiring a qualified sealing (drift seal), which will isolate the disposal areas. These excavations must be backfilled to 100% with backfill material of high quality, e.g. salt concrete M2. The composition of salt concrete M2 is 16.4 wt.% cement and fly ash, 13.4 wt.% water and 53.8 wt.% crushed salt. Category II includes openings that must be backfilled by more than 95% for stability reasons. The requirement of category III is an average backfill volume of 65% per mining field. The void-filling shall reduce leaching processes in the case of the inflow of unsaturated brines. Category IV includes mostly inaccessible excavations in carnallite layers. A backfill volume of more than 90% shall be reached, but can hardly be verified. For this reason only a degree of the backfilling of 50% is considered for the long-term safety analysis. The required quality of backfill material in category II – IV is less than in category I. The composition of salt concrete M3 applied in backfill category II-IV is 9.9 wt.% cement, 23.0 wt.% fly ash, 12.6 wt.% water and 54.5 wt.% crushed salt.

5.2 *Position of drift seals*

Figure 4. **Position of drift seals (left) and access counterhead potash seam B (right)**

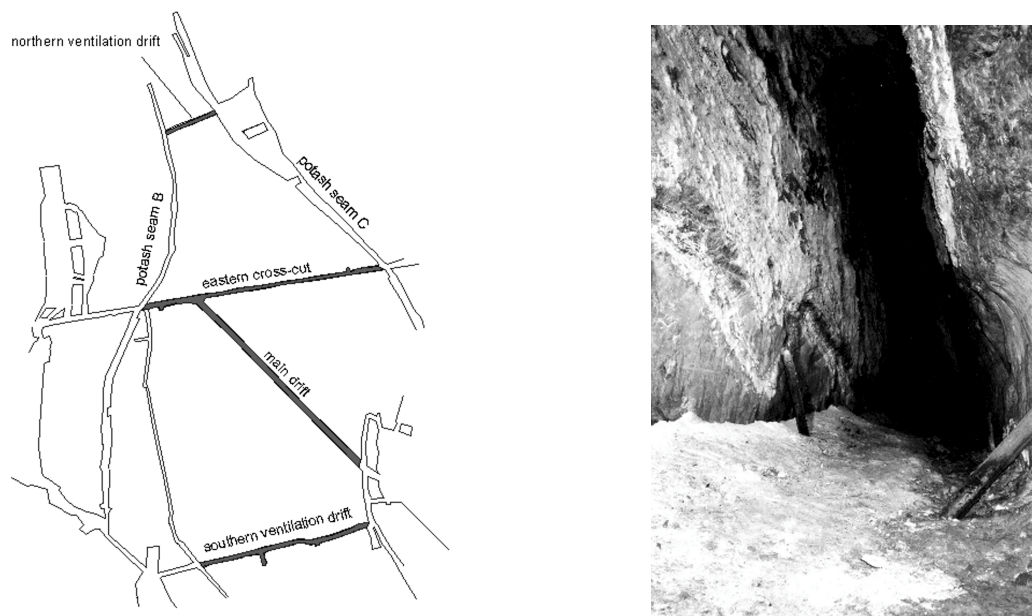

The closure concept requires the erection of 26 drift seals at different levels in the Bartensleben mine. As they separate the disposal areas from the residual mine the positions of the drift seals are defined by the geometric structure of the mine as well as by geological conditions. High

quality sealing of large cavities has to be avoided due to technical problems and a large excavation disturbed zone (EDZ). Additionally, the drift seals have to be placed in rock salt to avoid leaching processes. Fig.4 shows the drift seal placed between potash seams B (southern field, disposal area) and C (central part, potential pathway) separating the southern field from the central part. The drift seal in the northern ventilation drift on the 2nd level is the most severe location, as the thickness of the intact rock salt layer between potash seams B and C is only about 25 m. Thus, the drift seal's length is short. In addition, potash seams B and C were excavated extensively in the past, Figure 4. For this reason access to the drift seal's position is complicated.

6. Drift seals

Basic requirements on the drift seals arise from the long-term safety analysis [4], [5] as well as from restricted length and limited access. To assure agreement with the radiological long-term safety objectives the hydraulic resistance of the drift seals appears to be the crucial property. Restricted length of drift seals leads to a design, providing the drift seals serve as both seal and abutment to achieve a maximum of hydraulic resistance. Due to limited access the construction has to be simple.

Regarding the hydraulic resistance the drift seals consist of three main elements, the sealing body, the contact zone between sealing body and surrounding rock salt and the excavation disturbed zone (EDZ). Laboratory experiments indicate that the salt concrete will attain an initial permeability of at least 10^{-18} m^2 and in the design of the drift seals this value has become the main requirement. Brine migration through the seals might degrade their hydraulic behaviour due to chemical reactions, however. This could not be avoided because no material has been known that is chemically stable to all possible brines getting into contact with the seals. The chemical constitution of the brine depends on its flow path and could not be pre-determined due to the geometrical complexity of the mine and the salt structure.

Laboratory experiments and model calculations indicate that the hydraulic conductivity of a seal will increase depending on the amount and chemical constitution of the brine migrating through it. Penetration of the seals starts when a significant hydraulic gradient has established between the disposal areas and the remaining part of the mine. Due to the initially low permeability of the seals model calculations based on laboratory experiments show that in the worst case constitution of the brine they will keep their function for at least some 5 000 years [6] after having got in contact with that brine. The degradation of the drift seals has been taken into account in the safety analysis and has been shown to be tolerable.

6.1 Design of drift seals

Every drift seal consists of segments, each of them 25 ± 5 m long, of which several may be arranged one behind the other in order to meet the requirements. At minimum a drift seal consists of one segment, e.g. the drift seal in the northern ventilation drift (Figure 4). The length of segments is restricted to reduce the impact from geological movements as well as restraint stresses due to the heat of hydration (Figure 5). To assess the influence of geological movements the dimensions of small anhydrite blocks in the ERAM were looked upon a site specific natural analogue.

Figure 5. Schematic overview of a segment of drift seal

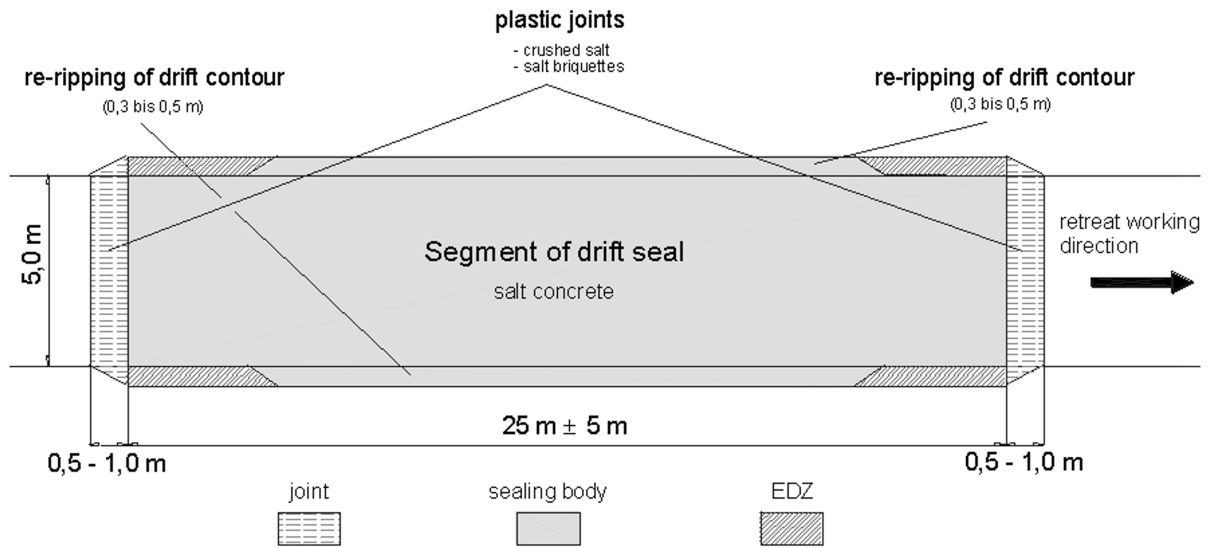
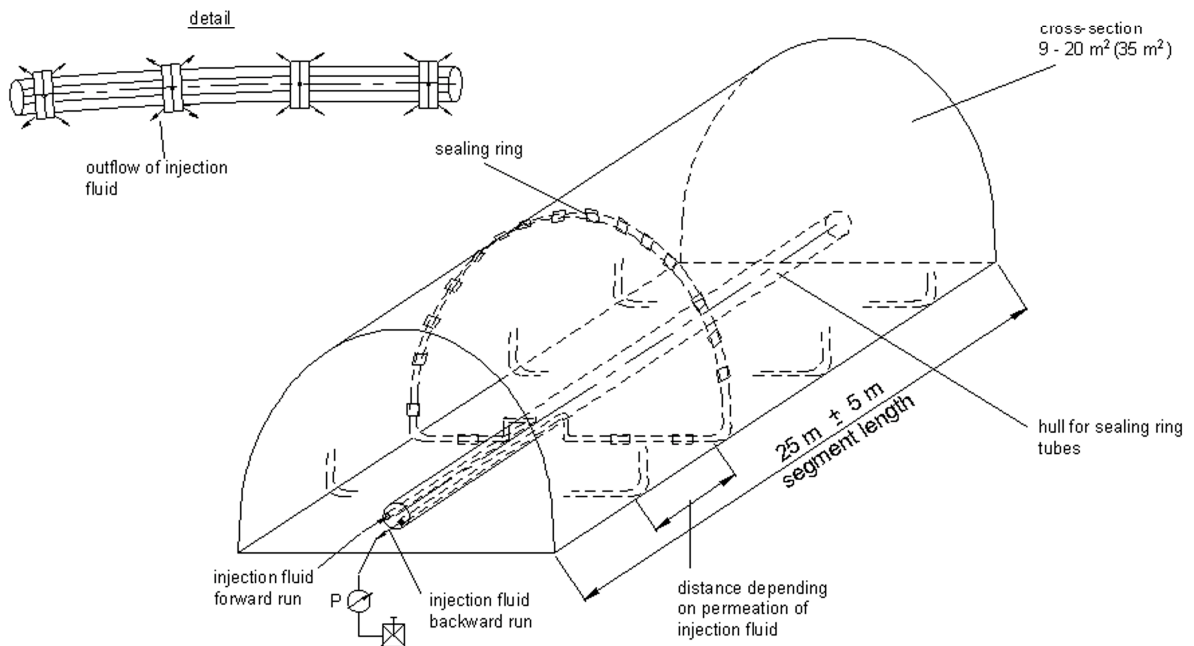

Figure 6. Basic layout of drift seal and detail



The segments are separated from each other by plastic joints containing salt material, e.g. salt briquettes or crushed salt (Figure 5). Prior to the construction of the segments the EDZ along the drift wall will be removed. After the construction of the sealing body cement grout is injected into the contact zone between the sealing body and the surrounding rocks using sealing rings connected to the

pump (forward/backward run) by a hull for sealing ring tubes, which will be over-drilled after having completed the injection process (Figure 6). The borehole itself is backfilled by salt concrete M2 afterwards. Thus, each segment is provided with a ring seal and is pre-stressed sufficiently to withstand the load of future fluid pressure. The whole structure serves as a seal and as an abutment leading to a maximum of hydraulic resistance in case of restricted length. By this force-transferring design relative sliding between the sealing body and the surrounding rocks is excluded and the tightness of the contact zone is guaranteed.

6.2 Sealing body material

As already mentioned above the salt concrete M2 contains fly ash as a relevant ingredient. Fly ash particles are spherical and most of them are smaller in size than cement particles. This characteristic property allows the fresh concrete to have a good flowability/workability, which is of major importance due to restricted access to the drift seal's position. The concrete is used in the sense of a mass concrete. Consequently, special attention has to be paid to hydration heat during the construction phase to avoid crack evolution. A maximum adiabatic temperature rise of 47.7°C was measured experimentally.

Figure 7. Failure and dilatancy bound of salt concrete M2 in comparison with rock salt

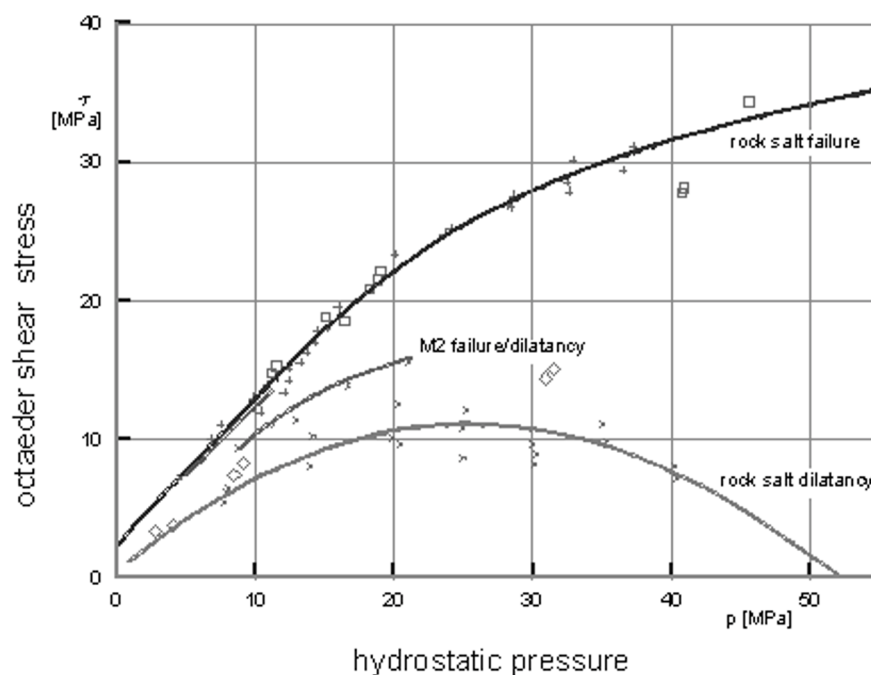

Dilatancy bounds of the salt concrete M2 were determined by laboratory tests to serve as a criterion for assessing crack evolution due to mechanical and restraint stresses. Dilatancy bounds of salt concrete M2 are given in Figure 7 in comparison to the failure bound and dilatancy bound of rock salt. The dilatancy bounds of salt concrete M2 exceed the dilatancy bound of rock salt, however, they were found to be strain rate dependent. Strain rates investigated up to now are 10^{-5} s^{-1} and 10^{-6} s^{-1} . In

contrast to rock salt the dilatancy bound and the failure bound of salt concrete M2 are nearly identical. Additional data of relevant material properties of salt concrete M2 are given in Tab.2, whereas permeability to gas is varying with the confining pressure (Figure 8). Permeability to brine was not determined experimentally, because the limits of the measuring equipment were exceeded. However, from the limits of the measuring equipment it was calculated that the permeability to brine is less than $3 \cdot 10^{-23} \text{ m}^2 - 6 \cdot 10^{-24} \text{ m}^2$.

Figure 8. Salt concrete M2. Permeability results from laboratory tests

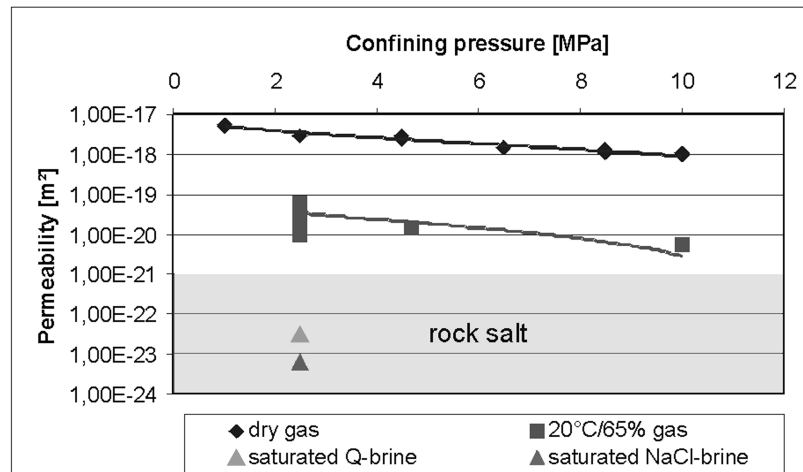

Table 2. Material properties of salt concrete M2 samples at different ages ≥ 28 d

Material properties	Range
Density [kg/m^3]	1 966 – 1 997
Uniaxial compression strength [MPa]	21.2 – 39.7
Uniaxial tensile strength [MPa]	2.04 – 3.03
Young's modulus [MPa]	11 700 – 23 900
Permeability to gas [m^2] (dried 20°C/65% rel. humidity)	$5.4 \cdot 10^{-18} - 5.3 \cdot 10^{-21}$
Permeability to brine [m^2]	$< 3 \cdot 10^{-23} - 6 \cdot 10^{-24}$
Threshold pressure [MPa] (brine saturated)	> 7

Because of crushed salt being the main ingredient of salt concrete M2 its deformation behaviour is much closer to the behaviour of rock salt than conventional concrete or conventional concrete mixed with saturated salt brine instead of water.

6.3 Proof of safety for drift seals

The permeability limit of 10^{-18} m^2 on average may be exceeded because of two reasons:

- mechanical failure and crack evolution;
- insufficient hydraulic resistance of the sealing body, the contact zone or the EDZ.

Mechanical stability and integrity (limitation of crack evolution) have to be proved during the construction phase as well as under dry and wet repository conditions in the long term. The interaction of the sealing body, contact zone and EDZ must be considered because of strong coupling.

Hydraulic resistance, however is of importance only under wet repository conditions. When proving sufficient hydraulic resistance the sealing body, the contact zone and the EDZ could be treated separately.

The safety of drift seals is shown by numerical calculations relying on the following load cases and safety evidence criteria.

6.3.1. *Proof of mechanical stability and integrity*

First, the stability and integrity of the drift seals under thermo-mechanical loading has to be proved the necessary condition for hydraulic resistance.

6.3.1.1. Kinematic stability of rigid body (sealing body)

The relevant load case arises under wet repository conditions. In this case the pressure difference along the seal results from the assumption of a brine column reaching up to the ground surface at one side of the drift seal and the dry emplacement area with usual air pressure at the opposite side. Rigid body resistance of the drift seals is governed by admissible shear stresses in the contact zone. The lower bound of admissible shear stress in the contact zone is the minimum normal stress multiplied by a common coefficient of friction. (> 0.3). The minimum normal stress is equal to the rock pressure after injection taking into account a relaxation phase.

6.3.1.2. Integrity of the sealing body

Concerning the integrity of the sealing body, i.e. limitation of crack evolution inside the sealing body, different load cases have to be considered. During the construction phase the temperature gradient due to hydration heat between the interior of the sealing body and the boundary has to be limited. At present a maximum temperature gradient of 20 K is admitted. Additionally, during the construction phase the sequence of injection and the injection pressure have to be chosen carefully. Site specific injection tests are necessary. Under dry repository conditions the relevant load case arises under maximum rock pressure. Integrity is proved by evaluating the local stress state inside the sealing body and using the dilatancy bound of salt concrete M2 as a safety evidence criterion. A further load case to be regarded is the combination of maximum fluid pressure at one side of the drift seal and the minimum normal stress (rock pressure) leading to the most unfavourable deviatoric stress state inside the sealing body. Again, the local stress state resulting from this load case is compared to the dilatancy bound of salt concrete M2.

6.3.1.3. Integrity of contact zone

Due to crack evolution in the contact zone the most unfavourable load case is the combination of maximum fluid pressure at one side of the drift seal and minimum normal stress (rock pressure) at the contact zone. The stresses induced by this load case have to be evaluated and the

minimum stress component at the contact zone is compared to fluid pressure, i.e. the fluid criterion $\sigma_1 > p_{\text{fluid}}$ is applied to prove safety.

6.3.2. Proof of hydraulic resistance of drift seals

After having shown the mechanical stability and integrity of drift seal the proof of sufficient hydraulic resistance has to be performed next step. As a first approach the proof will separately be carried out for the sealing body, the contact zone and the EDZ. In case of the sealing body and the contact zone the initial hydraulic resistance and the increasing permeability due to corrosion processes (long-term stability) have to be regarded. In the EDZ no corrosion will take place. As a permeability of 10^{-18} m^2 is required on average, a higher permeability of the EDZ may be compensated by a lower permeability of the sealing body taking into account the volumetric flow rate of the whole system. In a first approach, however, the three elements of the drift seal are considered separately.

6.3.2.1. Limitation of flow rate migrating through sealing body

This load case assumes maximum brine pressure at one side of the drift seal and usual air pressure at the opposite side resulting in the maximum hydraulic gradient possible. An initial permeability $k < 10^{-18} \text{ m}^2$ leads to a release of radionuclide that is sufficiently low. In addition long-term stability has been proven as corrosion due to NaCl or MgCl_2 saturated brines migrating through the seals proceeds sufficiently slowly during the required time period. As laboratory tests showed that the permeability of salt concrete M2 fulfils the requirement $k \leq 10^{-18} \text{ m}^2$ (Table 2, Figure 8) the required limited flow rate migrating through the sealing body and consequently sufficient long-term stability can be proved.

6.3.2.2. Limitation of flow rate migrating through the contact zone

The relevant load case for the contact zone is identical to that of the sealing body. Evidently, the same requirement of $k \leq 10^{-18} \text{ m}^2$ is the safety evidence criterion for the contact zone. According to German technical regulations in civil engineering [7] investigations on comparable structures are necessary for assessing the hydraulic resistance of contact zones. To gain a reliable data basis in situ tests are planned in the Asse salt mine investigating the contact zone of a 10-year old salt concrete seal by permeability tests, hydraulic fracturing and ultrasonic fault analysis. Additionally, mechanical and hydraulic properties of core samples from the Asse seal and the contact zone will be examined by laboratory tests, to get a better knowledge on the quality of salt concrete achieved in situ and its adhesion to the salt rock contour. If it finally turns out that the required permeability of 10^{-18} m^2 is achieved *in situ*, the corrosion process in the contact zone is sufficiently slow and long-term stability of the contact zone is guaranteed during the required time period.

6.3.2.3 Limitation of flow rate migrating through the EDZ

The relevant load case for the EDZ assumes maximum brine pressure at one side of the drift seal and usual air pressure at the opposite side resulting in the maximum hydraulic gradient. Due to the position of the drift seals saturated brine is assumed and therefore the long-term stability of the EDZ is automatically given. Thus, the only requirement concerning the EDZ is the limitation of permeability to $k \leq 10^{-18} \text{ m}^2$. In the ERAM permeability measurements in trimmed drifts showed values of $5 \cdot 10^{-17} \text{ m}^2 - 1 \cdot 10^{-20} \text{ m}^2$. The EDZ of the up to 70-year-old drifts will be removed before building the drift

seals. Thus, in the case of the EDZ a permeability of 10^{-18} m^2 on average seems to be obtainable. In the case of the EDZ permeability exceeds the limit value slightly. This can be compensated by a lower permeability of the sealing body because there is no danger of corrosion processes in the EDZ.

7. Summary and Conclusion

In this paper the basis of drift seals conception is given including a comprehensive analysis of the site specific situation and an overview of the closure concept. The requirements on drift seals and backfill respectively sealing material rely on inputs from long-term safety analysis. These aspects altogether lead to a simple and robust design of drift seals associated with a plausible way of proving the drift seals' compliance with the requirements.

Presently, the termination of concept planning is scheduled in 2003 followed by the begin of the licensing procedure.

References

- [1] Preuss J., Eilers G., Mauke, R. *et al.* (2002): Post Closure Safety of the Morsleben Repository, WM'02 Conference, February 24-28, 2002, Tucson, AZ, USA.
- [2] Preuss J., Müller-Hoeppe N., Schimpf C. (2000): The Interaction of the Evidence of Post closure Safety and Requirements to Backfill Materials for the Morsleben Repository, Proc. DISTEC 2000, September 4-6, 2000, Berlin, Germany.
- [3] Köster R., Maiwald-Rietmann H.U., Laske, D. (2002): Development of backfill materials in an underground salt repository, 6. Int. Workshop on Design and Construction of Final Repositories – Backfilling in Radioactive Waste Disposal, March 11-13, 2002, Brussels, Belgium.
- [4] Resele G., Oswald S., Wollrath J. *et al.* (2000): Morsleben nuclear waste repository – probabilistic safety assessment for the concept of extensive backfill, Proc. DISTEC 2000, September 4-6, 2000, Berlin, Germany.
- [5] Boese B.; Strock R.; Brenner, J. *et al.* (2000): Closure of the final repository of Morsleben according to the pore reservoir concept and the sealing concept and model calculations for the long-term safety, Proc. DISTEC 2000, September 4-6, 2000, Berlin, Germany.
- [6] Ranft M., Wollrath J., (2002): Time Scales in the Long-Term Safety Assessment of the Morsleben Repository, Germany, OECD/NEA Workshop on Handling of Time Scales in Assessing Post Closure Safety, April 16-18, 2002, Paris, France.
- [7] DAfStb (1996): Betonbau beim Umgang mit wassergefährdenden Stoffen, DAfStb-Richtlinie, Germany.

CROP – A PROJECT FOR COMPARATIVE DESCRIPTION OF NATIONAL CONCEPTS FOR DISPOSAL OF RADIOACTIVE WASTE

Roland Pusch
Geodevelopment AB, Sweden

Christer Svemar
SKB, Sweden

1. Scope

Nine partners representing Sweden (SKB), Belgium (SCK-CEN), Finland (POSIVA), France (Andra), Germany (GRS), Switzerland (NAGRA), Spain (ENRESA), Canada (OPG), and the US (DOECBFO) participate in the EC-supported project CROP, which is the synonym for Cluster Repository Project and aims at describing the various repository concepts for identifying similarities and differences. The ambition is to assist designers and modelers in the development of the respective concepts.

Design, construction and instrumentation of underground laboratories (URLs) and forthcoming repositories as well as modeling the engineered performance of national repository concepts in crystalline rock, salt and clay are defined and compared. The depth of location of the repositories is different – 250 to 1000 m – and also the design: the multibarrier philosophy is proposed for disposal in all types of rock but for salt the geological medium is considered to be the major barrier. The minimum time for effective isolation of the waste differs among national programs (E4 to E6 years) and so is the effort of modeling physical and chemical degradation of the engineered barrier system (EBS), which consists of canisters, embedding buffer and backfill, and plugs. CROP is focusing on the buffer and backfill and shaft, tunnel and borehole seals including plugs.

The temperature in the near-field is a most important factor for the repository performance. It will be in the interval 90-110°C for crystalline rock and clay, and up to 200°C for salt in the close vicinity of the waste according to the concepts, attenuating with increased distance from it. The heat and temperature gradient affects the groundwater flow and rock strain and thereby the evolution of the EBS in the first few hundred years and they are determinants of the chemical stability and hence required dimensions of the engineered barriers. Both the short- and long-term performance of the EBS are significantly affected by the groundwater chemistry.

2. Design (WP1)

2.1 Location

Structure, hydrology and geochemistry, rock stress conditions and seismicity, are technical factors that affect the site selection. In principle, crystalline rock, salt and clay shale show similar structural patterns with major discontinuities dividing the rock mass into large blocks that contain less important discontinuities of different size. They have different properties in the three geological media with respect to mechanical and hydraulic behaviour. Only major discontinuities – fracture zones in granite and claystone and clay shale and weak, water-bearing zones like clay seams in salt – are determinants of the location and orientation of repositories. They may be equally frequent in all rock types and need to be identified by geological mapping, deep borings and geophysical investigations for working out structural, geohydrological and geochemical models [1,2]. Plastic clay shows a different structure by being more homogeneous.

The principal stresses and their mutual ratios determine the mechanical stability of the near-field rock and hence have an impact on the location of a repository. This is exemplified by the conditions in the central part of the Canadian shield where spalling and local rock failure occur at excavation deeper than about 300 m. Figure 1 shows examples of the interaction of a repository and typical crystalline and salt rock structures. Tectonically induced shearing takes place primarily along major weaknesses, and differences in piezometric conditions in those in crystalline and brittle clay cause groundwater flow in the system, leaving the rock matrix more or less with stagnant water.

Figure 1. Schematic picture of underground research facilities interacting with typical systems of discontinuities. Left: Fracture zones in granite controlling large-scale groundwater flow and deformation (Stripa URL). Right: Asse salt anticline with large internal discontinuities influencing large-scale strain

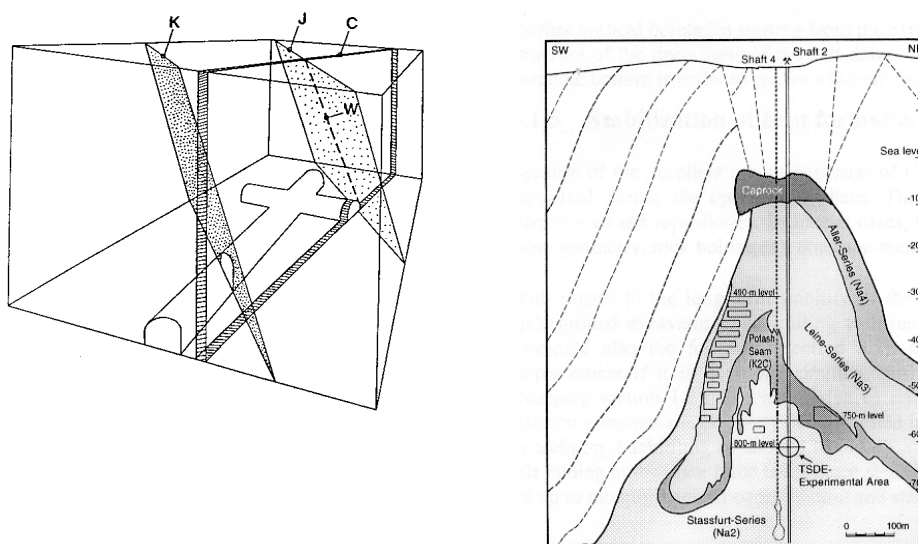

2.2 *Geometry and layout*

The amount of waste, spent fuel and reprocessed waste, and their distribution in the repositories determine the heat evolution and hence the selected repository geometry, i.e. the spacing of tunnels and deposition holes. Waste disposal is planned to be made in different ways in the concepts depending on the rock stability and behaviour as well as on cost. Large rooms with many canisters embedded in clay buffer or crushed salt is an option for crystalline rock and salt, respectively. Long sub-horizontal tunnels with rows of axially centered and oriented canisters is proposed for crystalline rock and claystone or plastic clay (NAGRA, ENRESA, OPG, SCK-CEN), and vertical deposition holes bored perpendicularly from the floor of horizontal tunnels with one or several buffer-embedded canisters in the holes is a candidate concept for SKB (KBS-3), POSIVA and Andra in crystalline rock. The shape and size of the holes and tunnels are selected on the basis of stability estimates and on the required dimensions of EBS components.

2.3 *Rock stability*

The stress/strain properties of the rock control the stability of the near-field rock. They are scale-dependent and related to the rock structure. For good granite and gneiss the unconfined compressive strength of core samples is in the interval 150 to 300 MPa but the volume-dependent frequency of discontinuities in the matrix significantly affects the bulk strength and deformation moduli of the rock mass. For claystone and plastic clay the corresponding values are much lower, which means that due respect has to be paid to the size and orientation of deposition holes and tunnels for avoiding unstable conditions. Creep is of very limited importance for crystalline rock but may be of significance for clay. In clays large strain may lead to failure and permanently enhanced hydraulic conductivity. For plastic clay and salt, creep is of primary importance because it has the beneficial function to cause convergence of rooms and drifts and perfect homogeneity of the repository rock.

Figure 2 illustrates the general features of some repository concepts. For the case of deposition holes bored from TBM tunnels at 500 m depth, the floor around the deposition holes may be in a critical stress situation (Figures 3a and b). Even if macroscopic failure does not take place comprehensive fine-fissuring may occur close to the holes yielding “excavation-disturbance” and an increase in hydraulic conductivity [3].

Figure 2. **Examples of repository concepts**

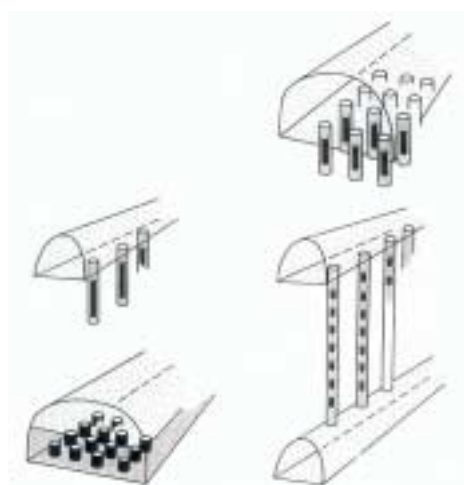

Figure 3a. Geometry of KBS-3 case used in stress calculation (Figure 3b)

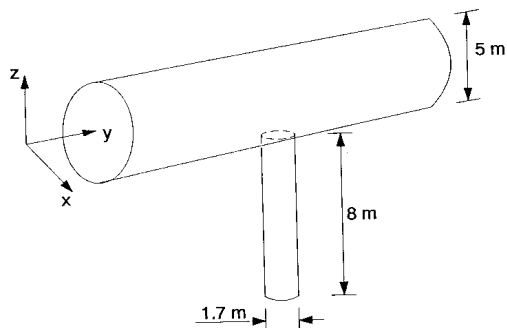
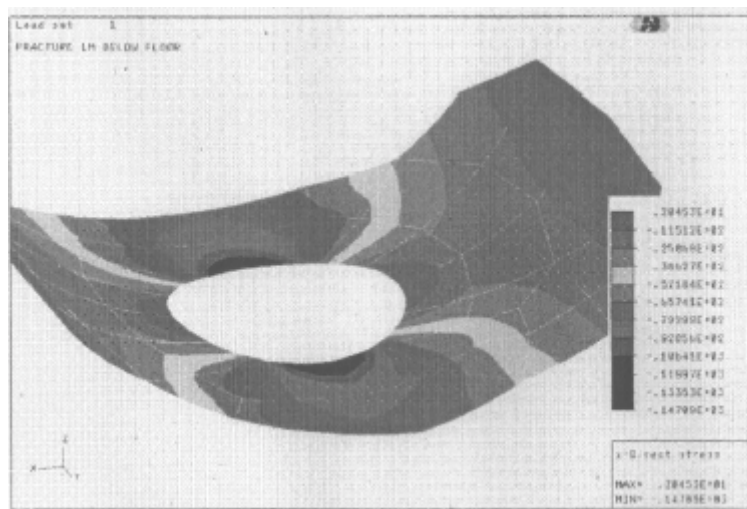

Figure 3b. Predicted critical stress conditions in the tunnel floor at the junction of a deposition hole [3]. The rock stresses are: the major principal stress 30 MPa horizontal and perpendicular to the tunnel, the intermediate stress (15 MPa) horizontal and parallel to the tunnel, and the minor stress (10 MPa) vertical. Acoustic emission technique shows the same pattern



2.4 Water flow through repository rock

Groundwater flow is the major radionuclide transport mechanism in crystalline rock and clay shale in which it takes place in interacting fracture zones of different size and extension in the far-field and in systems of discrete fractures in the near-field [4]. The rock matrix between major water-bearing features has a low hydraulic conductivity, and plays a minor role except where fracturing has been induced like close to tunnels, shafts and large holes where it can be considered as a “porous medium” in flow calculations. In plastic clay diffusion is the dominant transport mechanism. In salt in WIPP, brine flow can occur from intersected porous zones in the salt. Figure 4 shows an example of

calculated “channel” flow in two intersecting fracture zones, which represents a major flow and radionuclide transport principle.

Figure 4. **Example of predicted concentration plots during the transient stage of release of contaminants. After 245 years the distribution is uniform in the “pipe” and in the fracture zones [4]**

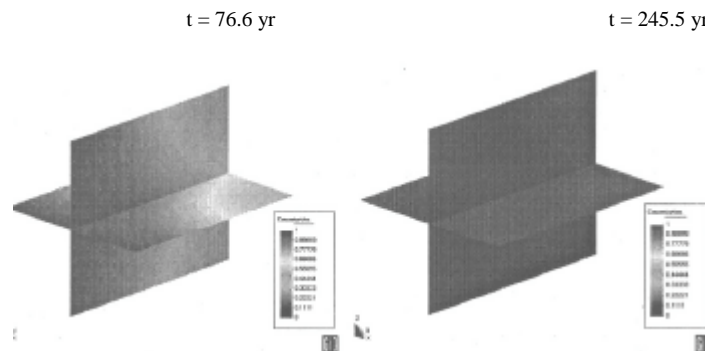

3. Construction

3.1 EDZ

The technique for excavation of tunnels and long deposition holes, which will have a length of 300-400 m according to several concepts, changes the properties of the rock close to the openings. The excavation-disturbed zone (EDZ), which results both from overstressing as illustrated by Figure 3 and from the disintegration induced by the cutting operation, forms a conductive annulus around deposition holes and tunnels in all geological media. It has a higher hydraulic conductivity than the virgin rock and has an extension that depends on the stress situation in the rock and the brittleness as well as on the excavation method. Blasting causes strong disturbance and a continuous EDZ that may be many thousand times more permeable than that of undisturbed rock and that extends 1-2 m below the floor and a few decimetres from the walls and roof. Tunnel boring causes disturbance to a depth of only a few centimeters.

The different rheological performance means that EDZ in crystalline rock maintains its conductivity for long times while it tends to self-seal with time in clay and ultimately becomes perfectly tight in salt. A continuous EDZ means that it serves as a major water transport pathway in the repository unless it is cut off by constructing tight plugs that extends into the surrounding rock with grouting of the rock/plug contact. The issue of identifying, characterizing and sealing of the EDZ is the first of the major safety-related issues identified in the project.

3.2 EBS

Man-made, i.e. engineered barriers, are used in all concepts for creating a tight and physically and chemically stable isolation of the waste containers, that are usually termed canisters. The canisters make up a primary barrier and are surrounded by a second barrier of crushed host rock,

clay (buffer) or cement. Tunnels and shafts are sealed with crushed host rock, clay-based backfills and plugs.

Canisters can be very corrosion-resistant, like SKB's iron/copper containers, or of limited chemical stability as exemplified by steel canisters. They have different length/diameter ratios, which has an impact on their strength, deformability and weight. The chemical interaction between buffer and metal is also different and can lead to cation exchange and precipitation, which may alter the rheological properties of the buffer.

Buffers and backfills are of different types. For salt, crushed salt and salt blocks will be used for backfilling and sealing, and for crystalline rock and clay, smectitic clay is a primary candidate. Prefabricated dense smectitic clay blocks with a dry density of up to 2000 kg/m^3 and of handable size, like the ones used by ENRESA in the Febex project, can be prepared in large amounts using ordinary compaction facilities, but also very big blocks can be prepared for isolating canisters of the KBS-3 type (Figure 5). NAGRA's concept of placing canisters in a row in long tunnels (holes) implies that they rest on a foundation of highly compacted clay blocks while the rest of the space is filled with very dense pellets of the same smectite clay blown in or "augered". Uptake of water from the rock will lead to expansion of the clay components in all the concepts and ultimately to an equilibrium state with the canisters embedded by homogeneous, practically impermeable clay.

Figure 5. Ring-shaped block for surrounding a canister (Clay Technology AB). Weight about 2 tons, diameter 1.75 m and height 0.4 m. The block was made by uniaxial compaction under 100 MPa pressure



The ultimately water-saturated smectitic clay materials have a hydraulic conductivity that is illustrated by Figure 6. For saturation with salt water the conductivity is almost the same as for fresh water when the density exceeds about 1900 kg/m^3 but for lower densities strongly brackish and salt water give a significantly higher conductivity and lower swelling pressure. A very important fact is that smectite clay treated with Ca and natural Ca bentonites do not have a stable physical form at lower densities than about 1600 kg/m^3 because of the poor gel formation potential. Their hydraulic conductivity is much higher than that of Na smectite.

The expandability of smectites is of fundamental importance for their self-sealing potential and for establishing a tight contact with canisters and surrounding rock. This potential is very high for smectite clay at common densities for the buffer, i.e. 1900-2000 kg/m³, and is appreciable for clays in Na form even at densities lower than about 1600 kg/m³, below which Ca smectite does not exhibit any swelling pressure at all.

Figure 6. **Hydraulic conductivity of Na-smectite clay [1]. The lower curve is for saturation and percolation with low-electrolyte water. The upper curve is for ocean salinity**

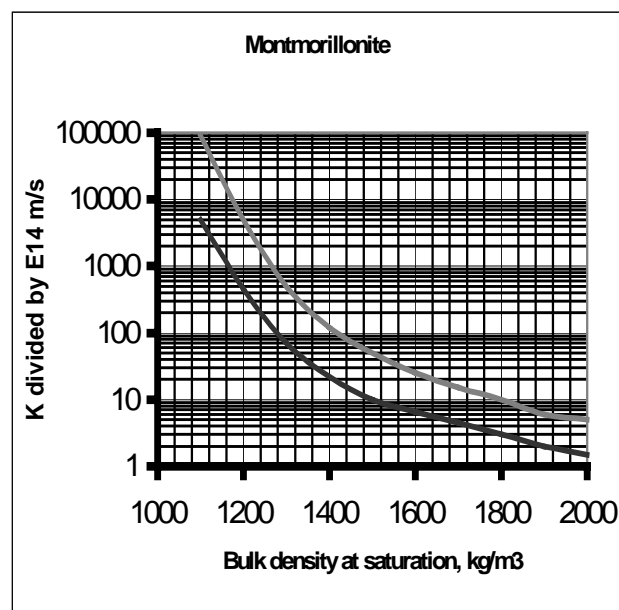

Cementitious seals and concrete are options for Andra's concept intended for crystalline rock and clay sediments, and for SCK-CEN's repository in clayey sediments. According to the latter concept the repository tunnels are concrete-lined with the canisters contained in a continuous steel tube, which is surrounded by a masonry of highly compacted sector-shaped clay blocks.

Tunnels from which deposition holes will be bored according to the SKB and POSIVA concepts are planned to be backfilled with smectitic soil that is moved in and compacted layerwise to form a slope. The smectite component of the backfill has a rather low density even though the backfill is dense and the conductivity is therefore much higher than that of the buffer. The swelling pressure is low but can be raised sufficiently much to provide support to tunnel roofs. The properties of the backfill material are of importance since poor homogeneity and insufficient density may turn it into a major hydraulic flow conductor and cause significant expansion and softening of the upper part of the buffer in the deposition holes.

3.3 *Plugs*

The importance of tight *plugs* in drifts and shafts is realised in all concepts and has been in focus for some of them. One example is the American WIPP repository in salt (Figure 7). Tests have

been made and several large-scale experiments are running today or being prepared in URLs. Still, the matter has not been very deeply examined and is the second major safety-related issue identified in the project.

Figure 7. **Proposed plug construction of the licensed US WIPP repository for low- and medium level radioactive waste (US DOE)**

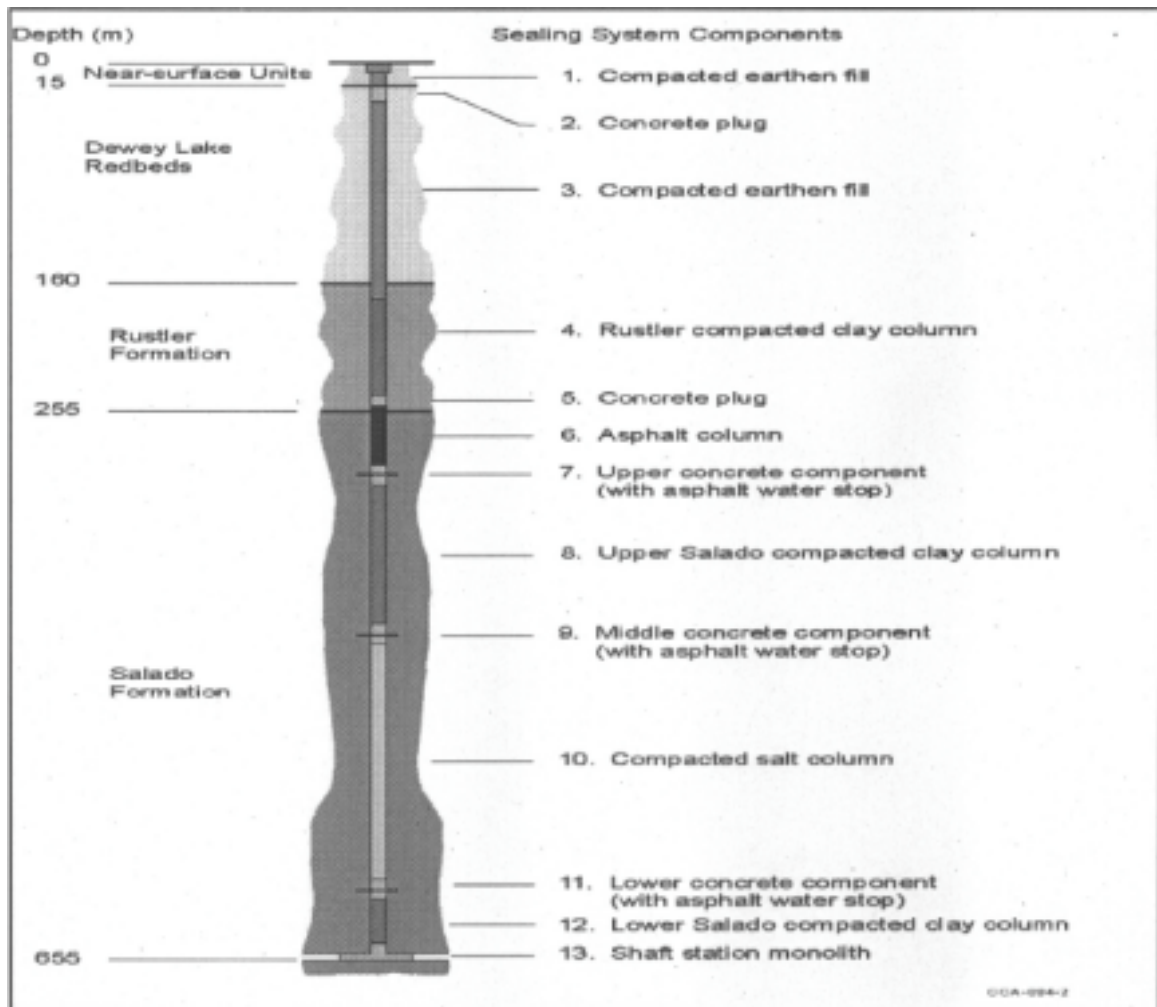

Temporary and permanent plugs will be required in tunnels and shafts. Temporary bulkheads will be required if application of canisters or backfills has to be stopped for a longer period of time and they will also be needed when individual tunnels have been filled so that tight confinement of the backfill must be obtained. Plugs have to be placed in strategic positions with respect to water inflow as well as to practical aspects, like the need for creating temporary and permanent separation of transport and deposition tunnels. In SKB's underground laboratory at AEspoe a concrete plug, extending into recesses in the confining rock and equipped with bentonite O-ring seals, has been constructed. Simpler plugs for temporary isolation may well be made by shotcrete while plugs for very long duty may have to be constructed by masonries of highly compacted clay blocks.

Rock sealing by grouting may be required as complement to plugs and also where strong water inflow occurs in the tunnels and holes in the construction phase for avoiding problems when emplacing buffer and canisters and applying tunnel backfill. Such inflow is related to the presence of

major water-bearing discontinuities in the rock, which therefore need to be identified before rock excavation can be made in the construction phase. Pre-grouting parallel to blasting or TBM excavation may be required and temporary drainage arranged by placing discharge pipes in the deposition holes and at the bottom of tunnels in the backfilling phase.

4. Experimental procedures and instruments

4.1 Experiments

A major purpose of constructing the URLs and performing experiments in them is to find out how well one can predict the location and properties of practically important rock structural features – particularly strongly water-bearing rock fracture zones and mechanically weak rock – and to test techniques for waste application, and also to investigate the performance of EBS systems. This has comprised application of rock characterisation methods based on geophysics and geohydrology and experiments for simulating real conditions for evolution of the EBS.

A typical scenario in all the URLs has been to bring full-sized canisters into deposition holes or tunnels with buffer or backfill separating them from the surrounding rock and to record strain and change in the physical constitution of the buffer caused by temperature gradients and water inflow from the rock. The evolution of the EBS to reach a homogeneous state is just the initial phase followed by a hydrothermal period and later by a very long period with normal temperature. Naturally, only the first phase can be studied because of the slow processes involved but it is of importance also to the long-term performance since permanent chemical and mineralogical changes may take place in it. Figure 8 illustrates the distribution of water content and temperature in the clay surrounding a heater in the Stripa URL [1].

Figure 8. **Temperature-driven redistribution of the original water content (10 %) of clay surrounding a 600 W heater after a few months in tight rock (BMT, Stripa Project), [1]**

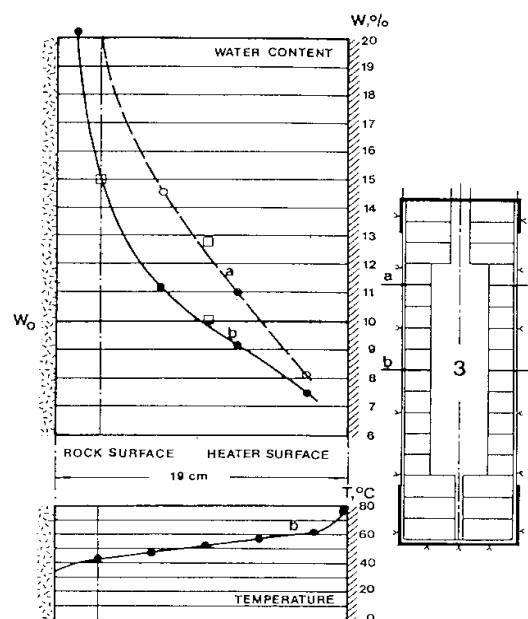

4.2 Selection and application of instruments

Processes of major interest for assessing the performance of near-field rock, buffers and backfills are 1) temperature evolution, 2) hydration of buffers and backfills, 3) development of swelling pressure, 4) displacements (canister movements), 5) development and extent of EDZ (clay), 6) chemical changes (mineralogy and porewater), 7) biological changes. They are referred to as THMCB processes.

Recording of the temperature evolution in the canister-embedding buffer of clay and salt is rather trivial and has been performed in all geological media by use of well operating instrumentation of corrosion-protected thermocouples or fibre optics and advanced data acquisition systems. Recording of water uptake has been made in SKB's, ENRESA's, AECL's and NAGRA's field experiments using psychrometers and electrical resistance technique. Swelling pressure and water pressure have been measured by use of Gloetzl and vibrating string techniques in all geological media and displacements have been measured by applying extensometers and electronic gauges. Chemical changes in the porewater of clay have been successfully measured in experiments where clay constitutes the host rock (SCK-CEN), while measurement of changes in canister-embedding clay in current experiments (SKB) have not been successful. Biological processes have not been studied in EBS *in situ*.

As a whole, the instrumentation used in the various URLs appears to work satisfactorily although several important processes cannot be recorded like chemical and mineralogical changes of the buffer clay in the course of the hydrothermal EBS tests. At this time such changes, which are expected, cannot be identified and quantified until excavation takes place.

5. Conceptual and theoretical modelling (WP3)

5.1 THMCB modelling

THMCB modelling of EBS has been considered in all URLs with emphasis on HM and THM behaviour. The basis for selection and development of the numerical tools is a simplified conceptual model like the one for the KBS-3-related Prototype Repository project at AEspoe URL. The simplified model of the EBS components are those shown in Figure 9.

Figure 9. Interacting EBS components of a KBS-3 deposition hole

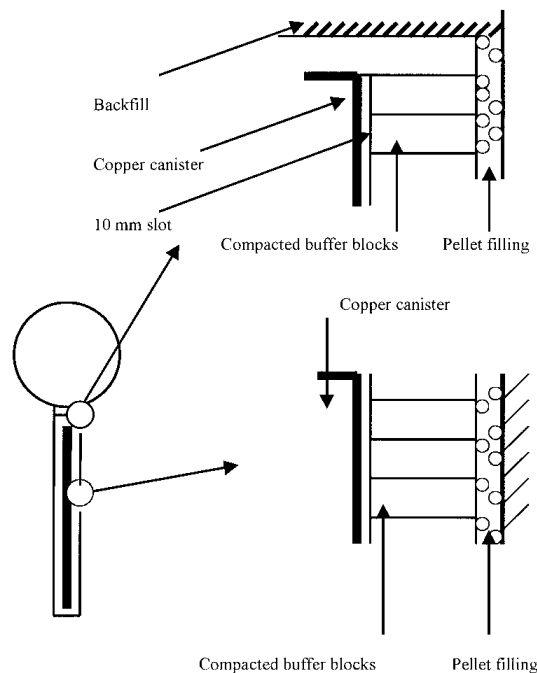

The evolution of the KBS-3 buffer and in principle all clay buffers in the clay and crystalline rock concepts involves:

- Redistribution of initial porewater generated by the thermal gradient across the buffer.
- Homogenisation and subsequent consolidation of the pellet fill under the swelling pressure exerted by the hydrating and expanding dense blocks.
- Uptake of water from the rock and backfill leading to hydration of the buffer.
- Expansion of the uppermost part of the buffer which displaces the overlying backfill.
- Consolidation and shearing of the buffer caused by the canister load.
- Alteration of the porewater chemistry and associated changes in buffer properties.
- Dissolution and alteration of minerals and precipitation of chemical compounds.

In the first phase the heat conductivity of the inner, drying part of the buffer decreases while the wetting of outer parts make them more heat-conductive. This causes a steep temperature gradient that has chemical effect since silicate minerals in the buffer close to the heater will give off silica that migrates towards the rock and precipitates in the outer part of the buffer. The silicification causes some cementation and brittleness of the clay. Desiccation and vapour attack will cause similar effects close to the canisters. The chemical processes involved in the EBS evolution are not yet fully understood and represent the third major safety-related issue evolving in the project.

Development of theoretical models for the evolution of clay-based EBS is focused on the initial phase of maturation, i.e. the development of temperature and, coupled to it, redistribution of the initial porewater content in the buffer and backfill, as well as on uptake of water from the rock. For this purpose several theoretical approaches have been made, like the five models that are being applied in SKB's Prototype Repository project at AEspoe URL for crystalline rock [5]. A major problem for the modelers is to define the hydraulic boundaries of the buffer clay: the rock around the deposition holes gives off water through discrete fractures with a largely unknown hydraulic transport capacity, the matter being complicated by the incompletely known conductivity of the shallow boring-disturbed zone (EDZ). Figure 10, which shows the water saturation rate according to a model worked out by the German BGR organisation, demonstrates the impact of water pressure in the near-field rock.

Figure 10. **Water saturation versus time for the case of continuously pressurised EDZ in KBS-3 deposition hole by 1 MPa, and the case with virtually no pressure and water uptake through 2 water-bearing fractures (Calculation by Lutz Liedtke, BGR), [6]**

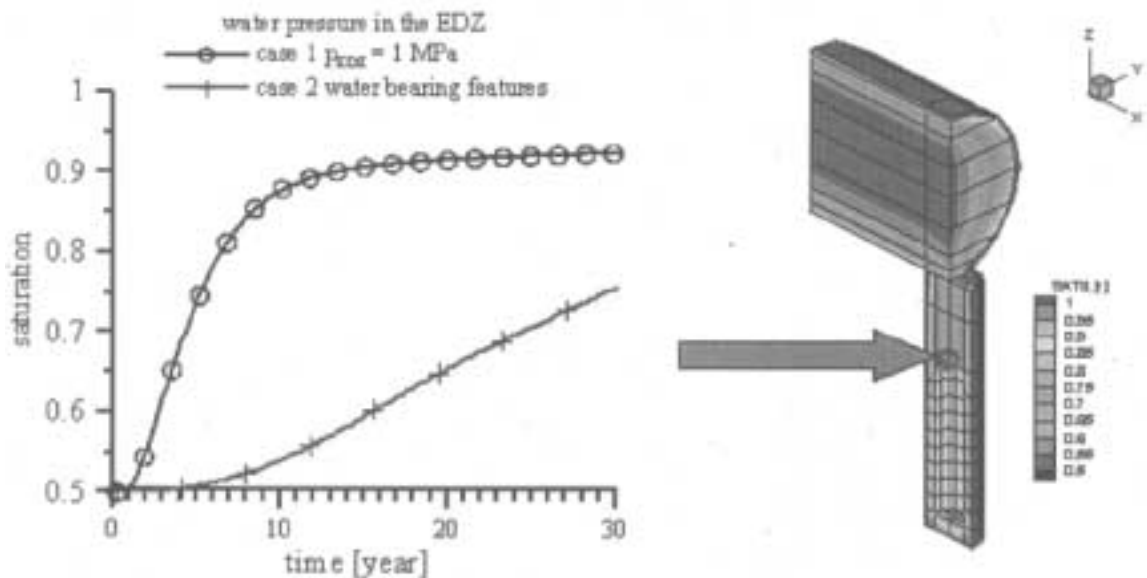

The difficulty in taking the rock constitution into consideration when predicting the saturation rate of the buffer clay is illustrated by Figure 11 which shows the porewater pressure situation after 4 years in a calculation for the KBS-3 concept using the ABAQUS code [7]. One concludes that very significant suction still persists in the rock and buffer if water is assumed to enter through fracture-free rock matrix and even where there is just one sub-horizontal water-bearing fracture. The problem of correct assessment of the role of the EDZ is definitely a key question for crystalline rock and clay shale.

Figure 11. Porewater pressure (kPa) in the rock after 4 years. Without fracture (left) and with fracture in the right picture [7]. Very significant suction persists in both cases

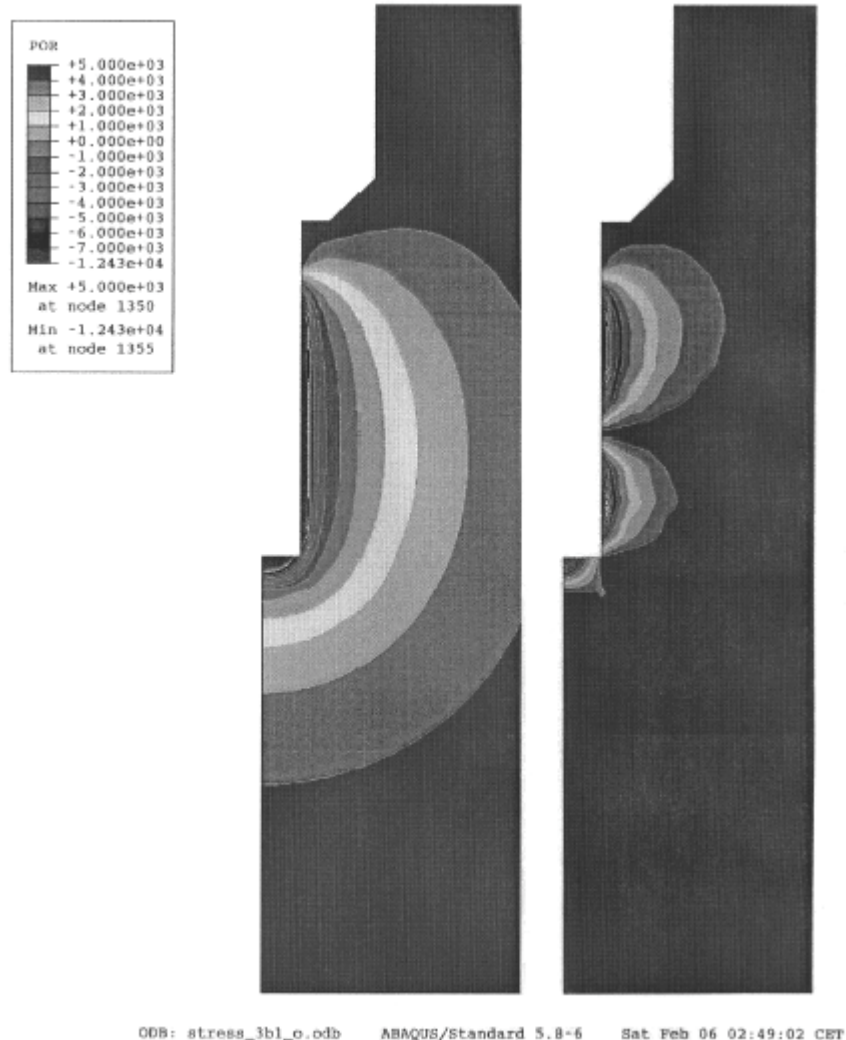

5.2 Creep modelling of rock (TM)

While the geometrical boundaries of deposition holes and tunnels can be taken as fixed in crystalline rock they undergo transient movement in clay and salt. The process is termed creep and has the nature of stochastic heat-assisted slip across energy barriers where the mechanical stresses are sufficiently high – usually more than 1/3 of the shear strength determined by conventional quick testing. This matter has been thoroughly investigated for the salt URLs WIPP and ASSE, which has led to empirically derived models for predicting long-term creep in salt. Purely thermodynamical models can not be used for any host rock since there is a scale-dependence: larger volumes mean that larger discontinuities with different stress/strain behaviour become involved. Also, there is a critical strain, meaning that the continuity of the rock mass is lost when the strain is sufficiently large: blocks will not be in full contact and may fall into tunnels and holes. Furthermore, bulk creep is affected by local discontinuities like clay seams and variation in salt composition (i.a. halite/sylvite).

The WIPP model considers the impact of local discontinuities like clay seams. GRS's model for ASSE is derived from basic thermodynamical creep theory but is essentially empirical. Both serve as practical tools for estimating the rate of convergence for a limited period of time.

GRS uses the following formula for steady state (secondary) creep rate [8]:

$$\epsilon_s = A \cdot \exp\left(\frac{-Q}{RT}\right) \cdot \left(\frac{\sigma}{\sigma^*}\right)^n$$

A = constant (s^{-1})

$n= 5$

Q = activation energy in $J \cdot mol^{-1}$

σ^* = (reference stress) 1 MPa;

R = universal gas constant: $8.314 J \cdot mole^{-1} K^{-1}$

The URLs in salt have offered very good opportunities to measure creep for predicting the time to obtain total convergence of rooms, tunnels and holes, the process being illustrated by Figure 12.

Figure 12. **Schematic illustration of convergence of a drift in the WIPP repository**
[Leif Eriksson]

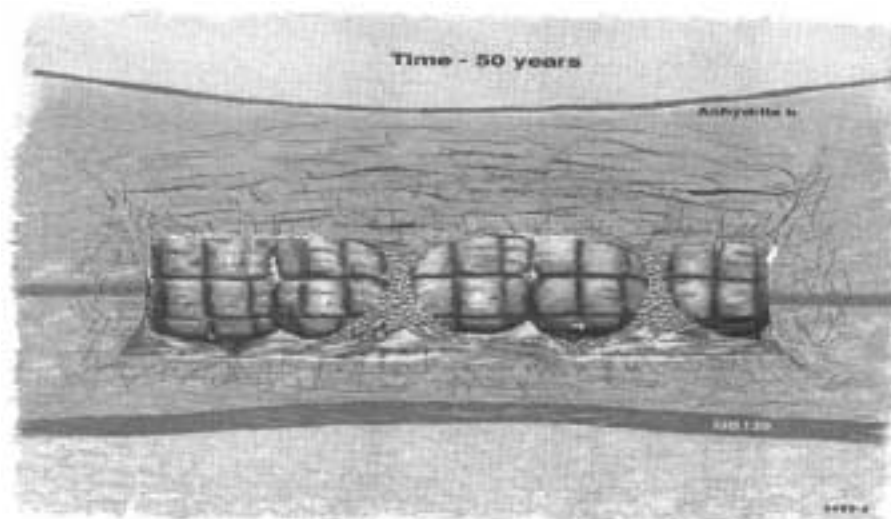

5.3 Creep modelling of clay barriers (TM)

A question that has been raised frequently is the risk of creep-induced sinking of heavy canisters in clay buffer. A few of the theoretical models worked out comprise components that take creep under constant volume conditions and creep involved in (secondary) consolidation into account. They are empirical and do not allow for extrapolation over thousands of years. Hence, a fourth safety-related issue has been identified in the project.

5.4 *Theoretical modeling, TCB*

Conceptual models for chemical processes in buffer clay have been worked out for the respective repository concepts and transformed to simple theoretical form and included in some of the theoretical EBS models. However, the understanding of the mechanisms leading to changes in the pore-water chemistry of buffer clay, including dissolution and precipitation phenomena, is far from complete. A higher priority should consequently be put on increased understanding of the chemistry for extrapolation of the chemical evolution in the EBS over long periods than on refinement of THM models to precisely predict the development of swelling pressures or creep etc in the relatively short water saturation period.

The possibility of practically important microbial activities in the EBS is realised by all investigators and conceptual models for their performance and impact on canisters have been worked out. However, detailed knowledge of the environmental conditions for survival and multiplication is still not complete and no theoretical models appear to be at hand for predicting microbial activities in the EBS. This is the fifth safety-related issue that has been identified

6. **Conclusions**

- There are obvious similarities in design philosophy among the repository concepts, and the testing programs are similar. The instrumentation is similar as well although more effort is made to determine creep in the URLs in salt and clay than in crystalline rock.
- Identification, characterisation and sealing – where appropriate – of EDZ is a major task that requires further investigations. The EDZ is most important in the hydration phase of buffers and backfills but might be a major transport path for radionuclides escaping the canisters.
- Location and construction of plugs for temporary or permanent sealing performance in repositories is matter that needs further consideration, both with respect to their impact on the large-scale groundwater flow and for cutting of EDZ.
- Long-term creep in salt and clay host media as well as in the buffer or backfill in any host medium requires more investigation for making safe predictions with respect to the location of canisters and compaction of backfill in a very long time perspective.
- The understanding of mechanisms leading to changes in the porewater chemistry of buffer clays, thereby affecting their physical properties in both short- and long-term perspectives, needs much more research. The reason is that possible changes in mineral composition and cementation can have a very significant effect on the isolating capacity of the EBS.
- Microbiology needs to be considered and its safety implications in each host medium identified.

References

1. Pusch R, 1994. Waste Disposal in Rock – Developments in Geotechnical Engineering, 76. Elsevier Publ. Co. ISBN0-444-89449-7.
2. Rhen I, Forsmark T, Torin L, 2001. Prototype Repository. Hydrological, hydrochemical and temperature measurements in boreholes during the operation phase of the Prototype Repository. Tunnel Section I. Int. Progr. Report IPR-01-32. SKB, Stockholm.

3. Munier R *et al.*, 1999. Projekt JADE. Geovetenskapliga studier. Bergmekanisk inverkan på vattenomsättning i närfältet. SKB R-01-32. SKB, Stockholm. (Swedish text).
4. Popov V, 2002. Prediction of groundwater flow in rock with disposal of chemical waste in abandoned mines. Wessex Institute of Technology. LowRiskDT EC-supported project. Mid-term report.
5. Pusch R, 2001. Selection of THMCB models. AEspoe Hard Rock Laboratory. Int. Progress Report IPR-01-66.
6. Liedtke L, 2002. Rate of saturation of buffer clay. EC-supported Prototype Repository Project. Mid-term report.
7. Börgesson L, Hernelind J, 1999. Coupled thermo-hydro-mechanical calculations of the water saturation phase of a KBS-3 deposition hole. SKB Technical Report TR-99-41. SKB Stockholm.
8. Rothfuchs T *et al.* Mechanical properties of rock salt. Country Annex to CROP WP3 report. (Internal report, unpublished.)

THE ROLE OF THE EBS IN DEMONSTRATING POST-CLOSURE SAFETY OF THE PROPOSED YUCCA MOUNTAIN REPOSITORY

Robert J. MacKinnon

Yucca Mountain Site Characterization Office
Sandia National Laboratories, USA

1. Introduction

On July 23, 2002, after more than 20 years of in-depth scientific and engineering studies, the Yucca Mountain (YM) site in Nevada was legally designated by the President of the US as a site for a proposed nuclear waste repository. The US Department of Energy (DOE) may now seek a license from the US Nuclear Regulatory Commission (NRC) to begin constructing a repository for geologic disposal of spent nuclear fuel and high-level radioactive waste. DOE plans to submit a license application to NRC in 2004. If NRC grants a license, construction will begin in 2008 and the first waste will be received in 2010.

A unique feature of the Yucca Mountain site is its 500 to 800-meter-thick unsaturated zone (UZ). The emplacement drifts and engineered barrier system (EBS) for the potential repository will be located in the UZ, about halfway between the ground surface and the water table in a host rock unit consisting of volcanic tuff. The principal function of the EBS, using a design to complement the geologic system, is to help prevent water from contacting the nuclear waste. The components of the EBS include the ground support (steel sets with welded wire and rock bolts), a drip shield over the waste package, a two-layer waste package, a waste package emplacement pallet, and an invert (crushed tuff) at the base of the emplacement drift. The current repository design has an average thermal load at time of waste emplacement of approximately 1.4 kW/m with 50 years of ventilation during the pre-closure period.

The regulatory basis for the YM post-closure safety case, NRC regulation 10 CFR Part 63[1], was finalised in 2001. This regulation establishes the licensing requirements for disposal of nuclear fuel and high-level radioactive wastes in the proposed geologic repository at Yucca Mountain. The DOE's approach to demonstrating compliance with these requirements relies on multiple independent lines of evidence. These lines of evidence include 1) a repository design that provides defense in depth, 2) a performance assessment of the proposed repository, 3) a laboratory and field testing program, 4) natural and man-made analogues, and long-term management and monitoring.

This paper summarises the DOE's approach to demonstrating compliance with NRC licensing requirements, and in particular focuses on the role of the EBS in this approach. The majority of material presented here is summarised from the Yucca Mountain Science and Engineering Report [2]. The outline of the paper is as follows. The next section provides an overview of the location and design of the proposed repository. A section that outlines the DOE's approach to the post-closure

safety case follows this section. Finally, an overview of the EBS models in the Yucca Mountain total system performance assessment model is presented followed by a summary.

2. Location and EBS design

Yucca Mountain is located 160 km northwest of Las Vegas. The mountain consists of a series of ridges extending 40 km from Timber Mountain in the north to Amargosa Desert in the south and is made of layers of ashfalls from volcanic eruptions that happened more than 10 million years ago. The ash consolidated into a rock type called “tuff,” which has varying degrees of compaction and fracturing depending upon the degree of “welding” caused by temperature and pressure when the ash was deposited. Regional geologic forces have tilted the tuff layers and formed Yucca Mountain’s crest (Yucca Mountain’s shape is a ridge rather than a peak). Below the tuff is carbonate rock formed from sediments laid down at the bottom of ancient seas that existed in the area.

The DOE plans to build the repository in the unsaturated zone about 300 meters below the mountain surface and about 300 to 500 meters above the water table. Figures 1 and 2 present a schematic cross section of the proposed repository and the natural system at Yucca Mountain. The capacity of the potential repository is designed for the emplacement of 70 000 metric tons of heavy metal (MTHM). The materials that would be disposed include about 63 000 MTHM of commercial spent nuclear fuel (CSNF) waste, about 2 333 MTHM of DOE spent nuclear fuel (DSNF), and about 4 667 MTHM of DOE high-level radioactive waste. All waste forms transported to and received at the proposed repository would be solid materials.

Figure 1. **Cutaway of Yucca Mountain Geological Formations (TCw – Tiva Canyon Welded, PTn – Paintbrush Nonwelded, TSw – Topopah Spring Welded, CHn – Calico Hills Nonwelded)**

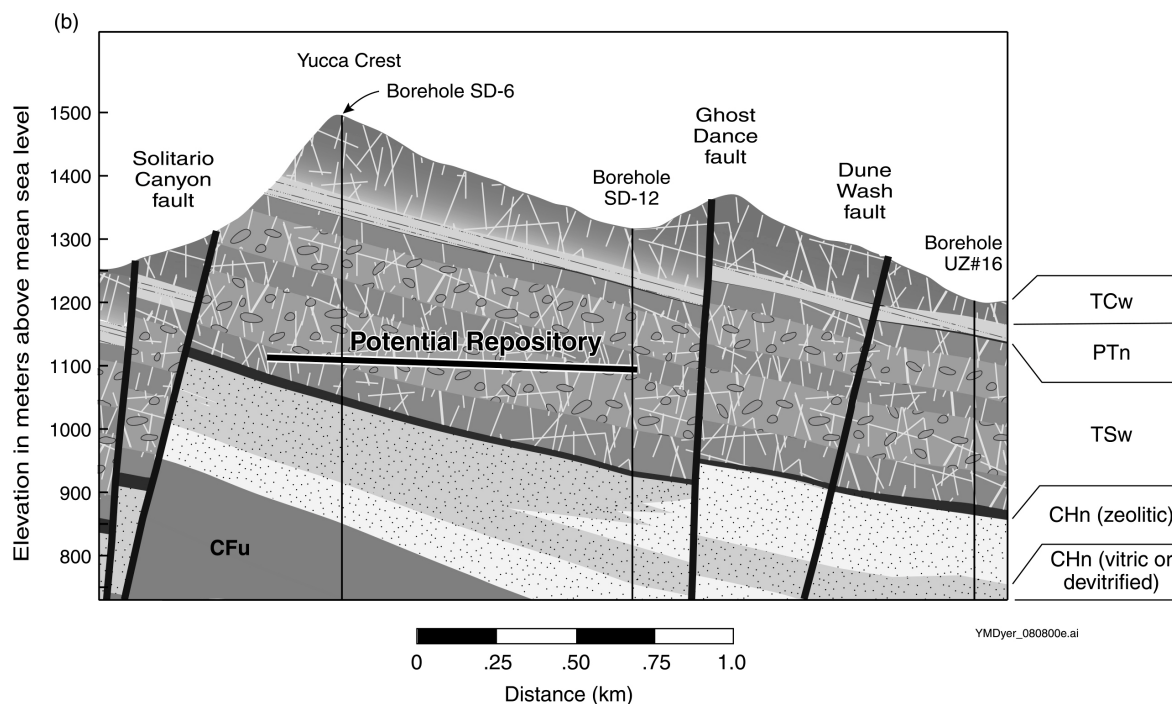
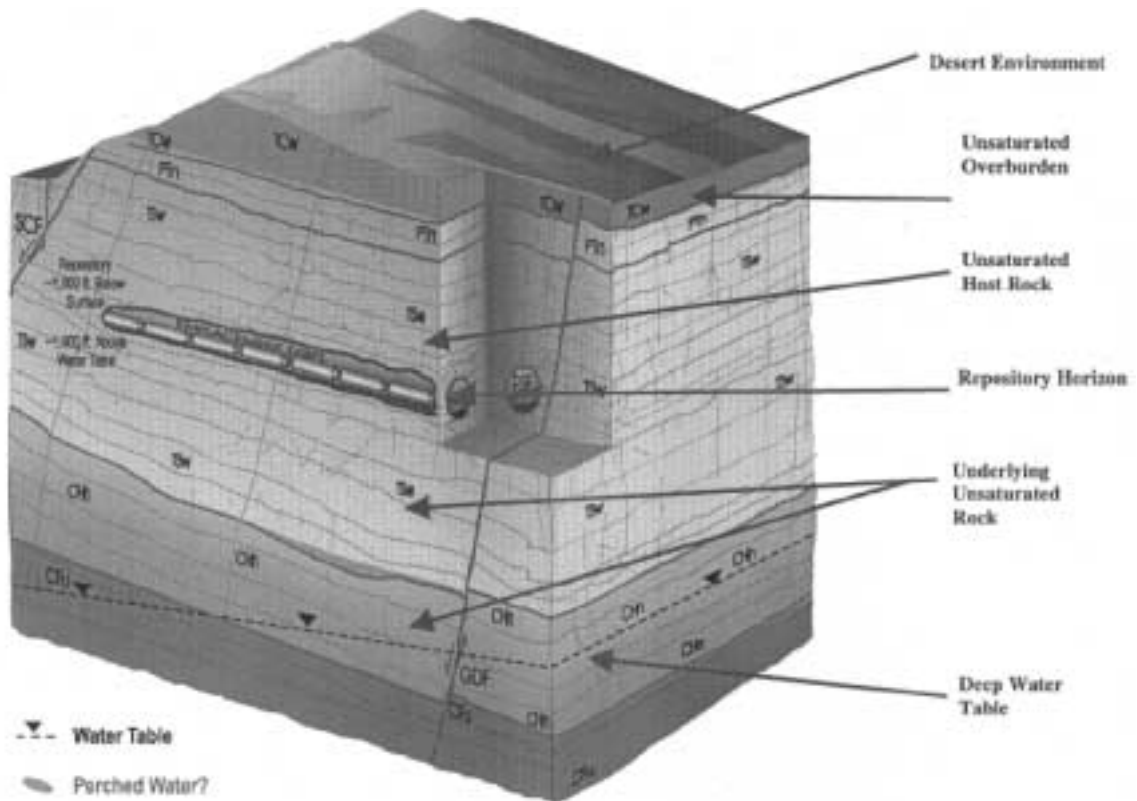

Figure 2. Natural System of Yucca Mountain (TCw – Tiva Canyon Welded, PTn – Paintbrush Nonwelded, TSw – Topopah Spring Welded, CHn – Calico Hills Nonwelded, Cfu–Crater Flat Undifferentiated, GDF – Ghost Dance Fault, SCF – Solitario Canyon)



The natural system and the EBS both contribute to repository performance. The natural system contributes by 1) limiting the amount of water entering the drifts and 2) limiting the transport of radionuclides through the system. The EBS is designed to complement the natural system and contributes by 1) using long-lived dripshields and waste packages to keep water away from waste, and 2) limiting release of radionuclides through retention, retardation, and diffusion barriers.

Preliminary engineering specifications have been developed for the EBS. These specifications have been developed based on an iterative process that integrates design, site-specific data, models, and analyses. These analyses include total-system performance assessments of the potential repository in 1991[3], 1993[4], 1995[5], 1998[6], 2000[7], and 2001[8,9]. The iterative process has focused on improving the understanding of the contribution of design features to performance of the repository over a range of thermal operating modes. If a design attribute is shown to have a significant impact on performance, then the attribute undergoes further evaluation to fully develop the positive contribution or minimise the negative contribution to performance. This flexible design will continue to evolve for license application (LA). Considerations of safety margin, defense in depth, insights from analogues, and expert judgements also help identify importance of repository components to performance.

Key design assumptions and requirements include:

- Design should support staged repository development
- Receive waste no later than 2010
- Design must meet 10 CFR Part 63 performance requirements for postclosure safety
- Flexible post-closure thermal operating mode
- Defense in depth

Staged repository development is a process that will permit decisions concerning the repository design, development, and operation to be made in a step-wise manner. That is, at each step in the process a decision whether to proceed would be made based on the regulatory and licensing requirements, the funding profile, and operating experience. The next stage would proceed informed by the experience of the previous stage.

The postclosure performance objectives for the potential geologic repository requires the DOE to include a system of multiple barriers, comply with the individual annual dose limit and groundwater protection standards, conduct a performance assessment, and assess the consequences of a specified human intrusion event. The objective incorporates the standards set by the EPA in rule 40 CFR 197[10] and adopted by the NRC in the final implementing rule, 10 CFR 63[1].

A flexible post-closure thermal operating mode will permit repository operation over a range of thermal environments. This range is being examined to further identify the potential performance benefits of different environmental conditions (lower and higher temperatures and associated relative humidity conditions) in the emplacement drifts. A defense in depth approach (or reliance on multiple system attributes) is an important element of the YMP safety case in that it provides a method of ensuring overall performance if one or more components of the repository system fail to perform as expected. Having safety components that do not share common failure modes provides defense in depth.

A schematic representation of the EBS is presented in Figure 3. In general, the major components of the base case design will include an areal mass load (approximately 60 metric tons of uranium [MTU]/acre), with closely-spaced waste packages. The EBS will include the following components:

Figure 3. Schematic of Engineered Barrier System Design Evaluated in the Total System Performance Assessment – Site Recommendation [7]

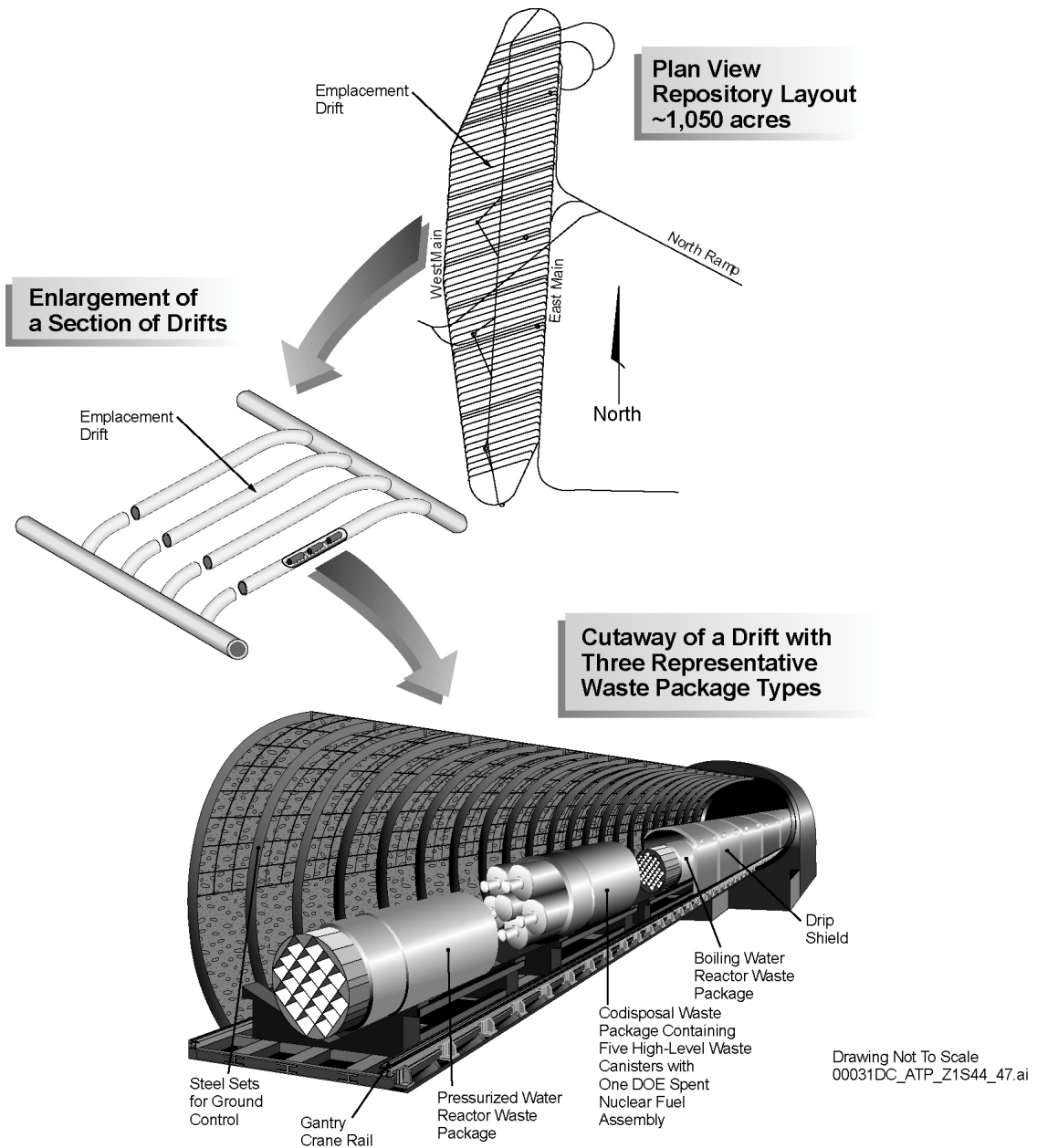

Drift Support (steel sets with welded wire and rock bolts):

A drift support system has been included in the design, primarily in support of preclosure safety.

Drip Shield (titanium alloy):

The drip shield is 1.5-cm thick and continuous in the drift over the waste packages. It serves to reduce the effect of rock fall and dripping on the waste package.

Waste Package:

Waste packages consist of an outer layer and an inner layer. The outer layer is a nickel-based alloy that is very resistant to aqueous corrosion and nearly totally resistant to humid air corrosion. The current reference corrosion-resistant material is 2 cm of Alloy-22. The inner layer is 5-cm thick stainless steel and serves three functions. First, it provides structural strength to resist rock falls, to support the internal components, to be supported by the emplacement pallet and to be handled. Second, the inner layer provides radiation shielding to reduce exterior surface contact dose rate. Third, the inner layer acts as a limited containment barrier for the radioactive waste inside the waste package. The current waste package reference design is based on a 21 pressurised water reactor spent nuclear fuel assembly waste package. Roughly the same size waste package can also accommodate 44 of the smaller boiling water reactor (BWR) SNF assemblies, five defense high level waste glass “logs” surrounding a central canister of DOE-owned SNF, or a naval spent nuclear fuel canister.

Alloy 22 Emplacement Pallet:

The emplacement pallets provide support for the waste packages during the preclosure period. The pallets will be emplaced along with the waste packages. Each waste package will rest on one pallet.

Invert:

The invert is designed to provide support for the waste package emplacement pallets and the drip shields. It will be composed of granular ballast (e.g., crushed, welded tuff), between steel beams that support the rails used during the pre-closure period for waste emplacement and performance confirmation equipment.

3. Approach to the post-closure safety case

The DOE’s approach to developing confidence in the safety of geologic disposal, known as the post-closure safety case, relies on multiple, independent lines of evidence. These lines of evidence are designed to collectively provide confidence and assurance that the repository will meet applicable regulatory performance standards after it is permanently closed.

The first element of the post-closure safety case is the quantitative analysis of repository performance, based on a comprehensive testing program that has evolved to address identified uncertainties and an EBS designed to complement the natural setting of the site. EPA and NRC regulations specify that DOE will perform a total system performance assessment (TSPA) to analyse and demonstrate that a repository can safely isolate high-level radioactive waste and meet the regulatory post-closure performance objectives.

To give the reader some understanding of the repository performance objectives an abbreviated summary of NRC performance objectives for the repository is provided below [1]. Note that all objectives are relevant to the EBS. References to the EBS are highlighted in bold italic font.

63.113 Performance Objectives for the Geologic Repository After Permanent Closure

63.113(a) The geologic repository must include multiple barriers, consisting of both natural barriers and an *engineered barrier system*.

63.113(b) The engineered *barrier system* must be designed so that, working in combination with natural barriers, radiological exposures to the reasonably maximally exposed individual are within the limits specified at § 63.311. Compliance with this paragraph must be demonstrated through a performance assessment.

(c) The *engineered barrier system* must be designed so that, working in combination with natural barriers, releases of radionuclides into the accessible environment are within the limits specified at § 63.331. Compliance with this paragraph must be demonstrated through a performance assessment.

(d) The ability of the geologic repository to limit radiological exposures to the reasonably maximally exposed individual, in the event of human intrusion into the *engineered barrier system*, must be demonstrated through an analysis that meets the requirements at §§ 63.321 and 63.322.

Because DOE recognises that uncertainty about future performance of the repository cannot be completely quantified, the safety case includes the following additional lines of evidence:

- Studies of natural and man-made analogues to the repository or to processes that may affect repository performance. These studies can further the understanding of natural processes related to repository performance that operate over long time frames or large spatial distances that cannot be easily tested.
- Laboratory- and field-testing program to improve understanding of coupled processes and uncertainties.
- Selection and design of a repository system that provides defense in depth and a margin of safety. The EBS is comprised of multiple barriers, so that safety of the repository does not depend on only one or two barriers.
- Long-term management and performance confirmation programme to ensure integrity and security of the repository and to ensure that the scientific and engineering bases for the safety case are well founded.

The approach outlined above is similar to approaches recommended by many national and international organisations that have investigated the technical and social issues related to nuclear waste disposal.

4. Total system performance assessment and EBS models

The Yucca Mountain repository system is a combination of integrated processes. The system can be conceptualised and modelled as a collection of component models that are coupled. This section briefly summarises the key aspects of the individual component models.

Eight principal model components in the TSPA are combined to evaluate the proposed repository system performance for nominal and disruptive event scenario classes [7,12]. The model components, listed in the general order information is passed from model to model, include:

1. Unsaturated zone flow
2. Engineered barrier system environment
3. Waste package and drip shield degradation
4. Waste form degradation and mobilization
5. Engineered barrier system flow and transport

6. Unsaturated zone transport
7. Saturated zone flow and transport
8. Biosphere.

Note that the EBS models include models 2 – 5. Scenario classes include the nominal (undisturbed) scenario class and the disruptive event scenario classes [11].

Nominal Scenario Class–The nominal scenario class exercises the model components to describe the anticipated sequence of processes that are likely to occur during the lifetime of the proposed repository (i.e., those with a probability of occurrence of close to one).

Disruptive Event Scenario Classes–The two disruptive event scenario classes exercise the model components to describe the sequence of events and processes that, if they occur, could have a significant consequence to public health, but whose probability of occurrence is very small. These classes consider volcanic eruption, igneous intrusion, and seismic ground motion as events that have low probability of occurrence during the time period of evaluation.

The igneous scenario class includes (1) igneous intrusion resulting in indirect releases via groundwater, and (2) volcanic eruption resulting in direct releases via ash dispersal and deposition. The seismic scenario class includes seismic ground motion resulting in indirect releases via groundwater. The nominal and disruptive scenario classes together contribute to the expected annual dose.

The TSPA model for license application, TSPA-LA, will be similar to the TSPA site recommendation model, TSPA-SR[7], with differences resulting primarily from improved quantification of uncertainties[12]. The eight TSPA-LA model components and their supporting submodels are illustrated in Figure 4. The model components are in the top row of the figure, with submodels pictured below the principal model component level. Submodels represent a further division of the principal model components. Submodels have arrows on the left side illustrating links to the parent model component. Arrows on the right side of submodels illustrate input feeds from submodels of other principal model components. Note that the EBS models are contained in the dash-line box. Figure 4 also illustrates the Disruptive Events models (i.e., nominal model components plus the atmospheric transport model for volcanic eruption modelling case, and repository level impacts depending on the disruptive event under consideration). Key aspects of the model components are described next.

Figure 4. Total System Performance Assessment-License Application Model Components and Submodels

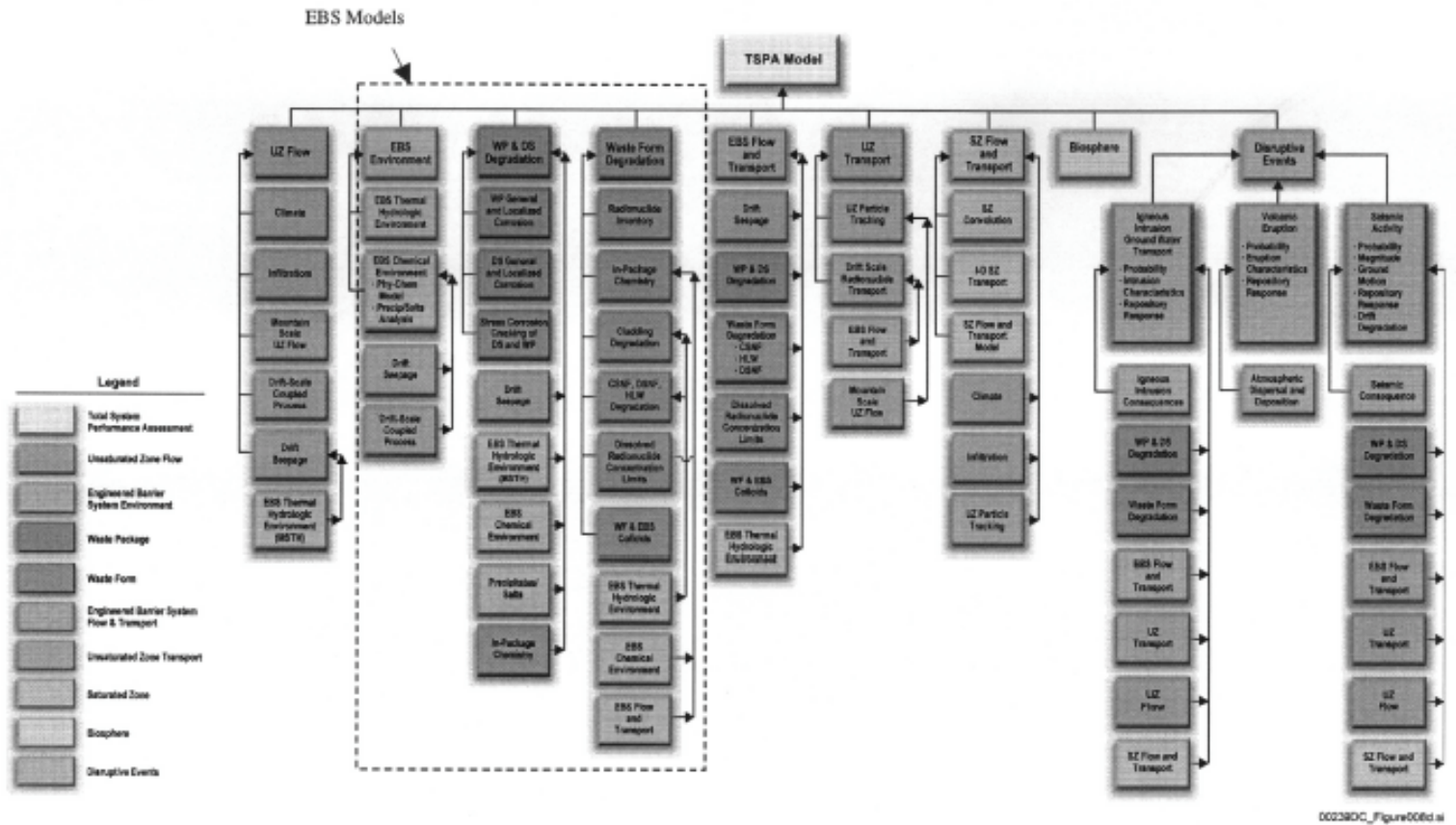

The natural system is modelled by the unsaturated zone (UZ)[13], saturated zone (SZ)[14], and Biosphere models [15]. The UZ flow model defines the temporal and spatial distribution of water flow through the unsaturated tuffs above and below the proposed repository horizon and the temporal and spatial distribution of water seeps into the waste emplacement drifts. The UZ Transport and SZ Flow and Transport models calculate the migration of radionuclides from the EBS through the unsaturated zone and saturated zones to the biosphere. The Biosphere model is used to predict transport of radionuclides through a range of possible biological pathways to the point where they are ingested or inhaled by humans.

The EBS models (EBS Environments [16,17], Waste Package and Drip Shield Degradation[18], Waste Form Degradation and Mobilization[19], and EBS Flow and Transport[16]) are used to evaluate the release of radionuclides from the EBS. The design is used as a basis for the evaluation, with key processes influenced by the design. These processes include thermal hydrology, chemical processes such as dissolution and precipitation, drip shield and waste package degradation, cladding degradation, waste form degradation, colloid formation and stability, and radionuclide transport within waste packages and through the EBS. The EBS models evaluate the following sequence of processes:

- The temporal and spatial evolution of thermal-hydrologic and chemical environments on the engineered barriers (notably the drip shields and waste packages)
- Degradation of the engineered barriers within the range of possible thermal-hydrologic and chemical environments
- The thermal-hydrologic and chemical environments within the waste packages once the primary containment has been degraded to the point that corrosion breaches penetrate the waste package
- The alteration rate of the waste form within the waste package, whether it is commercial spent nuclear fuel, DOE spent nuclear fuel (including naval spent nuclear fuel) or high-level radioactive waste, including immobilised plutonium waste forms
- The release of dissolved or colloidal radionuclides through the degraded engineered barriers to the host rock

5. Summary

The DOE's approach to developing the post-closure safety case relies on multiple, independent lines of evidence. These lines of evidence include total-system performance assessment, studies of man-made and natural analogues, selection and design of a repository that provides defense in depth and a margin of safety, and long-term management and monitoring. The regulatory requirements for the high-level radioactive waste program are based on quantitative assessments for the system's performance. For Yucca Mountain, performance assessment provides not only a means for estimating relative performance, but also a framework for organising and describing the site and designing the EBS.

The EBS is designed to complement the natural barriers in isolating waste from the environment. The EBS would contribute to waste isolation by 1) using long-lived dripshields and waste packages to keep water away from waste, and 2) limiting release of radionuclides through retention, retardation, and diffusion barriers.

The DOE has adopted an approach to the post-closure safety case that relies on multiple, independent lines of evidence to build confidence in the analyses of repository performance and assurance that the repository will meet applicable post-closure performance standards. The degree of safety margin (the difference between expected performance and the regulatory limit) and the independence of measures that provide defense in depth are continuing to be assessed, both qualitatively and quantitatively. The DOE is continuing to study analogues that may provide important additional information about the reliability of the performance assessment models. Performance confirmation activities will monitor the behaviour of the repository and enable future managers to continuously assess the technical bases for decisions about the repository. Collectively, these multiple lines of evidence are known as the post-closure safety case. Elements of the safety case include:

- Quantitative assessments of long-term performance. For Yucca Mountain, performance assessment provides not only a means for estimating relative performance, but also a framework for organising and describing the site and designing the EBS.
- Design of a repository that provides defense in depth – a system of multiple, independent, and redundant barriers designed to ensure that failure of one barrier does not result in failure of the entire system. The system would also provide a margin of safety against radionuclide release and a margin of safety compared to health and safety requirements.
- Qualitative insights gained from the study of natural and man-made analogues to the repository or to processes that may affect repository performance.
- Laboratory- and field-testing program to improve understanding of coupled processes and uncertainties.
- Long-term management to ensure integrity and security of the repository, and long-term monitoring to monitor the behaviour of the repository and enable sound and scientific and engineering bases for a later repository closure decision.

References

1. 10 CFR Part 63, Disposal of High-Level Radioactive Wastes in a Proposed Geologic Repository at Yucca Mountain, Nevada. Final rule. Readily available.
2. 2002. *Yucca Mountain Science and Engineering Report*. DOE/RW-0539, Rev. 1. Washington, D.C.: U.S. Department of Energy, Office of Civilian Radioactive Waste Management. ACC: MOL.20020404.0042.
3. 1992. Barnard, R.W.; Wilson, M.L.; Dockery, H.A.; Gauthier, J.H.; Kaplan, P.G.; Eaton, R.R.; Bingham, F.W.; and Robey, T.H. *TSPA 1991: An Initial Total-System Performance Assessment for Yucca Mountain*. SAND91-2795. Albuquerque, New Mexico: Sandia National Laboratories. ACC: NNA.19920630.0033.
4. 1994. *Total System Performance Assessment – 1993: An Evaluation of the Potential Yucca Mountain Repository*. B00000000-01717-2200-00099 REV 01. Las Vegas, Nevada: CRWMS M&O. ACC: NNA.19940406.0158.
5. 1995. *Total System Performance Assessment – 1995: An Evaluation of the Potential Yucca Mountain Repository*. B00000000-01717-2200-00136 REV 01. Las Vegas, Nevada: CRWMS M&O. ACC: MOL.19960724.0188.

6. 1998. *Total System Performance Assessment – Viability Assessment Base Case*. B00000000-01717-0210-00011 REV 01. Las Vegas, Nevada: CRWMS M&O. ACC: MOL.19981202.0279.
7. 2000. *Total System Performance Assessment for the Site Recommendation*. TDR-WIS-PA-000001 REV 00 ICN 01. Las Vegas, Nevada: CRWMS M&O. ACC: MOL.20001220.0045.
8. 2001. *FY 01 Supplemental Science and Performance Analyses, Volume 1: Scientific Bases and Analyses*. TDR-MGR-MD-000007 REV 00 ICN 01. Las Vegas, Nevada: Bechtel SAIC Company. ACC: MOL.20010801.0404; MOL.20010712.0062; MOL.20010815.0001
9. 2001. *FY01 Supplemental Science and Performance Analyses, Volume 2: Performance Analyses*. TDR-MGR-PA-000001 REV 00. Las Vegas, Nevada: Bechtel SAIC Company. ACC: MOL.20010724.0110.
10. 40 CFR Part 197, Public Health and Environmental Radiation Protection Standards for Yucca Mountain, NV; Final Rule. Readily available.
11. 2000. *Disruptive Events Process Model Report*. TDR-NBS-MD-000002 REV 00. Las Vegas, Nevada: CRWMS M&O. ACC: MOL.20000504.0295.
12. 2002. *Total System Performance Assessment-License Application Methods and Approach*. TDR-WIS-PA-000006 REV 00. Las Vegas, Nevada: CRWMS M&O.
13. 2000. *Unsaturated Zone Flow and Transport Model Process Model Report*. TDR-NBS-HS-000002 REV 00 ICN 02. Las Vegas, Nevada: CRWMS M&O. ACC: MOL.20000831.0280.
14. 2000. *Saturated Zone Flow and Transport Process Model Report*. TDR-NBS-HS-000001 REV 00. Las Vegas, Nevada: CRWMS M&O. ACC: MOL.20000502.0238.
15. 2000. *Biosphere Process Model Report*. TDR-MGR-MD-000002 REV 00 ICN 01. Las Vegas, Nevada: CRWMS M&O. ACC: MOL.20000620.0341.
16. 2000. *Engineered Barrier System Degradation, Flow, and Transport Process Model Report*. TDR-EBS-MD-000006 REV 00. Las Vegas, Nevada: CRWMS M&O. ACC: MOL.20000324.0558.
17. 2000. *Near Field Environment Process Model Report*. TDR-NBS-MD-000001 REV 00. Las Vegas, Nevada: CRWMS M&O. ACC: MOL.20000421.0034.
18. 2000. *Waste Package Degradation Process Model Report*. TDR-WIS-MD-000002 REV 00. Las Vegas, Nevada: CRWMS M&O. ACC: MOL.20000328.0322.
19. 2000. *Waste Form Degradation Process Model Report*. TDR-WIS- MD-000001 REV 00. Las Vegas, Nevada: CRWMS M&O. ACC: MOL.20000403.0495.

Sandia is a multiprogramme laboratory operated by Sandia Corporation, a Lockheed Martin Company for the United States Department of Energy's National Nuclear Security Administration under contract DE-AC04-94AL85000.

ENGINEERED BARRIERS SYSTEM MODELLING AND PERFORMANCE ASSESSMENT IN SAFIR 2

Xavier Sillen and Jan Marivoet
(SCK•CEN, Belgium)

Jean-Paul Boyazis, Philippe Lalieux, Peter De Preter and Johan Bel
(ONDRAF/NIRAS, Belgium)

Abstract

In 2001, ONDRAF/NIRAS completed a second Safety Assessment and Interim Report, SAFIR 2, on the Belgian research and development programme on geological disposal of radioactive wastes. This report presents the state of the art in Belgium about deep disposal of high and medium-level wastes in a clay formation. In SAFIR 2, the focus was very much on the capacity of the Boom Clay to fulfil its role as main barrier. Indeed, in many evolution scenarios it has been shown that the clay host formation plays the dominant role in performance assessment (PA) calculations. Nevertheless, the basic assumptions on which these PA calculations rest often depend much on processes which occur inside or in the vicinity of the engineered barriers system (EBS). In this respect, detailed EBS modelling appears complementary to PA calculations. To ensure the sound transfer of EBS behaviour understanding, a tight collaboration between experimentalists, modellers and PA specialists is required.

1. Introduction – the SAFIR 2 report

In 2001, ONDRAF/NIRAS completed a second Safety Assessment and Interim Report, SAFIR 2, on the Belgian research and development programme for geological disposal of radioactive wastes. The SAFIR 2 report is meant to inform the Belgian authorities of the technical and scientific aspects of high-level waste (HLW) and medium-level waste (MLW) disposal in poorly indurated clays. The SAFIR 2 repository concept is shown in Figure 1.

Although only the Boom Clay formation has been studied for SAFIR 2, no specific site is being selected. The report was by no means written as a safety case pending a licence application. On the contrary, this report presents an interim review of the state of the art in Belgium and will be a key reference to define –and to get approved– the next methodological research and development phase of the programme. SAFIR 2 covers the period 1990-2000 and its focus lies principally on the capacity of the Boom Clay as a geological barrier. In parallel with the research and development programme, the repository design and especially the engineered barrier system (EBS) will be revised and refined, an in-situ feasibility demonstration will be performed and all safety-relevant available data will be integrated by 2010-2012 in a safety case.

Figure 1. The SAFIR 2 repository concept

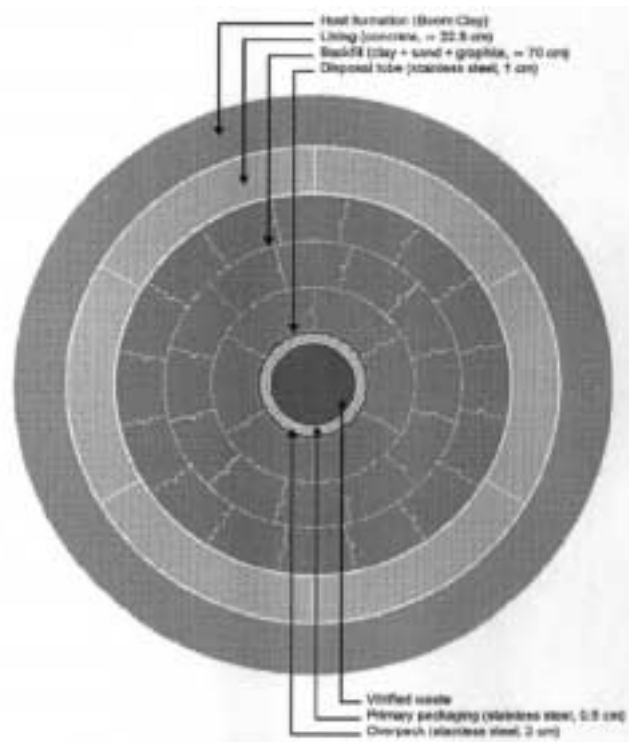
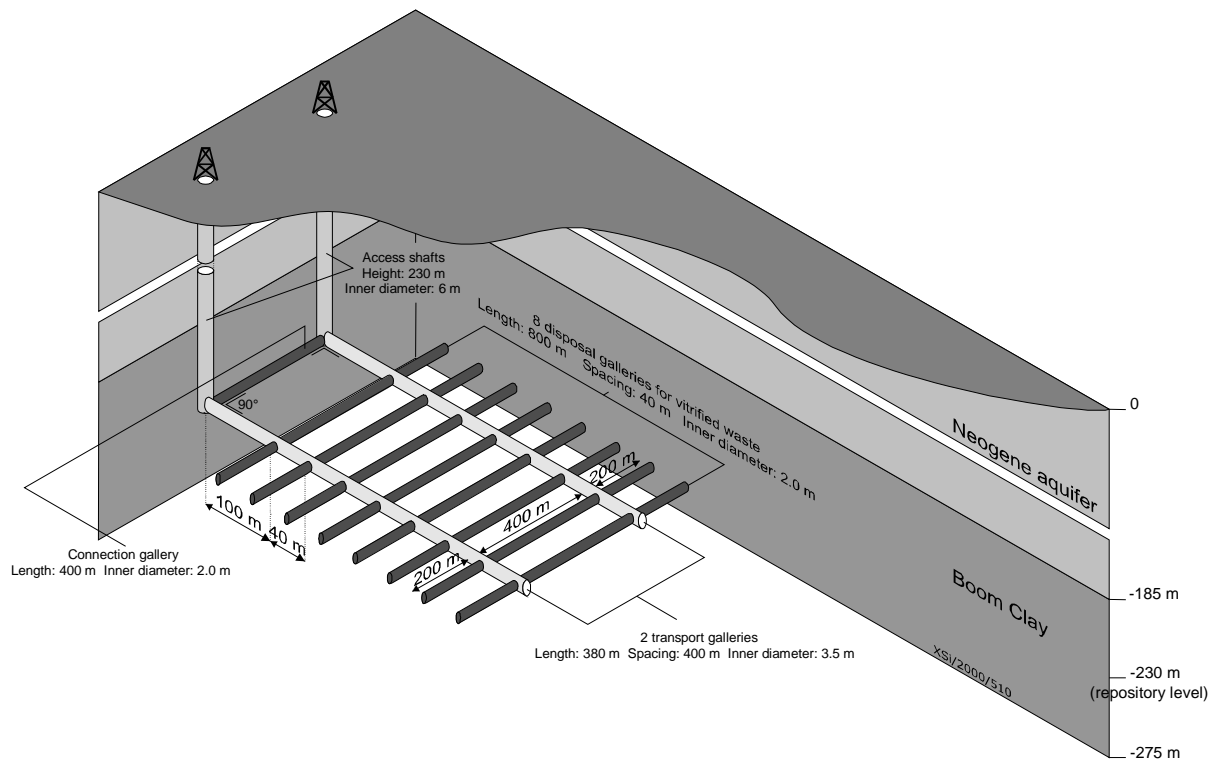

The conclusions from SAFIR 2 increase the confidence in the capability of the Boom Clay to effectively control the migration of radionuclides through molecular diffusion, advection being negligible. Favourable sorption capacities of the Boom Clay for several important nuclides was also demonstrated. In fact, performance assessment (PA) calculations have shown that the Boom Clay is, by far, the dominant barrier against nuclide migration in the normal evolution scenario.

2. The long-term safety functions

A safety function is defined as an action or role that the disposal system or its environment must perform to prevent the radionuclides present in the disposed waste posing an unacceptable hazard to humans or the environment.

There are four safety functions:

- The function of *physical containment C* aims to isolate the radionuclides from their immediate environment to prevent any significant release of radioactivity.
 - The sub-function of *watertightness C1* prevents water coming into contact with the waste.
 - The sub-function of *limiting the water influx C2* postpones the moment when the barriers that provide a watertightness function, and then the radionuclides, are contacted by infiltrating water.
- The function of *delaying and spreading the releases R* aims to slow down the migration of radionuclides towards the biosphere as much as possible to allow maximum radioactive decay within the disposal system.
 - The sub-function of *resistance to leaching R1* spreads the release of radionuclides by the waste matrix.
 - The sub-function of *diffusion and retention R2* delays and spreads the release of the radionuclides.
- The function of *dilution and dispersion D* brings about a reduction in the concentration of radionuclides that will eventually reach the biosphere, and so reduces their potential impact on humans and the environment.
- The function of *limitation of access L* aims to isolate the waste to minimise the probability and consequences of human intrusion.

The first two safety functions are performed by the disposal system as a whole or by one or more of its components. The third function is performed by the environment of the disposal system. The fourth function is performed, together, by the disposal system, its environment, and institutional measures.

3. The role of EBS

In the Belgian concept (see Figure 1), the relative performance of the EBS and the Boom Clay can be assessed from Table 1, which shows the fractions of the initial inventory of several radionuclides released by various compartments of the repository system in the normal evolution scenario. Comparing the fractions released by the bentonite buffer and the Boom Clay, it appears that the latter is the place where most of the safety-relevant radionuclides decay during their migration.

This is hardly a surprise, as the Boom Clay can be seen as a very thick (~50 m) bentonite-like buffer around the original buffer (~0.5 to 1 m). There are exceptions, such as the radionuclides having the lowest solubility limits which are trapped in the precipitate in the vicinity of the source and decay mostly there. For the longest lived radionuclides, a significant fraction of the inventory will escape from the Boom Clay, but that barrier is still expected to play the major role in delaying and spreading the releases in time.

Table 1. **Fraction of the initial inventory of several activation and fission products released by various compartments of the repository system (results presented from the inner to the outer compartments; the first compartment that releases less than 1% of the initial inventory is highlighted)**

	RELEASED FRACTION					
	Canister	Waste form	Precipitate	Buffer	Clay	Aquifer
C-14	0,79	0,37	-	0,24	6E-4	5E-4
Cl-36	1,00	0,55	-	0,53	0,41	0,41
Ni-59	0,98	0,98	-	0,72	5E-5	5E-5
Se-79	1,00	0,85	0,85	0,85	0,79	0,79
Zr-93	1,00	0,83	-	0,71	2E-3	2E-3
Tc-99	0,99	0,99	0,03	0,03	0,02	0,02
Pd-107	1,00	1,00	0,85	0,84	0,66	0,66
Sn-126	0,99	0,37	-	0,33	2E-3	2E-3
I-129	1,00	1,00	-	0,98	0,97	0,97
Cs-135	1,00	0,88	-	0,47	9E-6	9E-6
Sm-147	1,00	1,00	-	1,00	0,95	0,95

0,99 : Released fraction > 5%

0,01 : Main barrier (PA)

As a consequence, rather than retention the main role attributed to the EBS is to ensure that the Boom Clay retention capacity will not be jeopardised or reduced significantly by near field phenomena. Namely, it is requested from the EBS to limit the perturbations to the clay induced by the construction of the repository, its operation and subsequent degradation. For HLW and spent fuel in particular, the EBS has to ensure the physical containment of the waste during the thermal phase. This latter safety function is attributed to the waste package overpack.

4. EBS in PA

In the normal evolution scenario, the canisters and overpacks fail after the thermal phase. In contact with groundwater, the vitrified HLW and the spent fuel then start to slowly dissolve and the radionuclides are released. Some of these radionuclides may precipitate around the waste, while other migrate by molecular diffusion through the bentonite buffer and the Boom Clay. Ultimately, the radionuclides that have not decayed during the long migration process will reach the aquifer system and eventually the biosphere.

As pointed out above, the Boom Clay is the dominant barrier in this scenario. As PA is concerned with the long-term evolution of the repository system it is also interesting to mention the involved time scales. The characteristic time for the diffusion of radionuclides that are not sorbed on

the Boom Clay through the host formation is about 60,000 years. As many radionuclides are sorbed, some strongly, much longer transport times are expected. In contrast, the main processes taking place in and around the EBS occur on shorter time scales. The hydraulic transient will last from a few tens to a few hundreds of years, the thermal phase will not last more than a couple of thousands of years and the oxidising conditions around the canisters should only prevail during the first hundred of years.

Because of their limited retention role and the time scales involved, the EBS components are often either conservatively neglected in PA or lumped into the model of radionuclide transport through the host formation. For example:

- the contributions of the metallic disposal tube and the concrete gallery lining to the retention of radionuclides are entirely neglected;
- the canisters and overpacks are conservatively assumed to fail instantly at the end of the thermal phase;
- the slow dissolution of the waste matrix and the subsequent release of radionuclides is externalised as the source term of a the transport model;
- the bentonite buffer is directly included in the model of diffusive transport through the Boom Clay;
- the effective thickness of the Boom Clay is reduced to account for possibly enhanced transport in the excavation disturbed zone and ageing EBS.

In fact, the complete EBS was represented in most PA calculations reported in SAFIR 2 by a single mixing cell including a source term and solubility limits. For the normal evolution scenario, comparisons with higher resolution models have shown little or no difference with respect to relevant performance or safety indicators such as fluxes into the aquifers or individual dose rates.

The behaviour of some components of the EBS is explicitly modelled, however, when their performance is crucial in specific altered evolution scenarios. For instance, flow and radionuclide transport inside the EBS are computed to some detail for scenarios involving advective transport through the repository galleries and shaft. This might occur in case of poor sealing, human intrusion or undetected water conducting feature. Then again, the Boom Clay still prevail in many of these scenarios. For example, if the water flowing through the repository in the case of poor sealing has to come from the host formation, the flow rate can be as small as 40 litres per year in a 200 m long gallery due to the very low permeability of the Boom Clay.

5. Does the EBS matter in the PA of repositories in clay?

In many evolution scenarios the EBS is represented in a very basic way, if at all, in PA. Nonetheless, this does not mean that engineered barriers do not play a role in the overall safety of the repository system or that a detailed analysis of the EBS evolution is not needed. Even in cases where the EBS behaviour is not directly modelled in PA, it nonetheless determines essential PA assumptions, for example:

- the chemical behaviour of the EBS can be of paramount importance to ensure that canister integrity lasts until the end of the thermal phase and to limit the subsequent dissolution rate of the waste forms;
- the mechanical performance of the EBS affects the extents of the disturbed clay zone;

- a low hydraulic conductivity of EBS components reduce the likeliness of significant advective transport through the repository in case of a local failure of repository seals.

Because of this, modelling of the processes taking place in the EBS is useful for repositories in clay. In particular, PA specialists need to assess whether:

- a detailed process-level model justifies or not the assumptions made for a PA model (example: the corrosion of the overpack is slow enough to prevent contact between radionuclides and water during the thermal phase, so 'cold' migration parameters can be used in PA);
- results of process-level models warrant an update of the values of the parameters of the models used in PA (example: altered sorption capacity of the excavation disturbed zone due to oxidation);
- some processes need to be directly implemented in PA models of altered evolution scenarios (example: corrosion gas driven flow and transport).

6. Conclusions and perspectives

In SAFIR 2, the focus was very much on the capacity of the Boom Clay to fulfil its role as main barrier. In the normal evolution as well as in some altered evolution scenarios it has been shown indeed that the clay host formation plays the dominant role in PA calculations. Nevertheless, the basic assumptions on which these PA calculations rest often depend much on processes which occur inside or in the vicinity of the EBS.

In the Belgian programme, it is acknowledged that significant uncertainties remain on the behaviour of EBS components such as the overpack (corrosion process) and the buffer (physico-chemical evolution during the thermal and chemical transients). In fact, the post-SAFIR 2 era opens with an extensive review of EBS design alternatives, with emphasis on the choice and expected behaviour of materials (compatibility), proven and robust industrial solutions (feasibility) and the simplification of underground operations during the operational phase.

Beyond feasibility, technological and economical aspects, the design of the EBS should aim at keeping the integrated PA as robust and defensible as possible. Nevertheless, detailed EBS modelling is sometimes unavoidable to duly justify PA assumptions or to demonstrate whether (and how) PA models need to be enhanced, particularly in connection with new or altered evolution scenarios. To this aim, it is sometimes necessary to apply process level models that were developed on the basis of laboratory or in-situ experiments to the time frames and the spatial scales relevant to PA. This can only be achieved in a sound way through tight collaboration between experimentalists, modellers and PA specialists.

References

SAFIR 2 (2001) Safety Assessment and Feasibility Interim Report 2. ONDRAF/NIRAS, Brussels, Belgium, NIROND 2001-06 E.

EBS MODELLING AND PERFORMANCE ASSESSMENT FROM H12: RESULTS, CONCLUSIONS AND FUTURE PRIORITIES

Hiroyuki Umeki, Hiroyoshi Ueda and Morimasa Naito
Numo, JAPAN

Masao Shiotsuki
JNC, JAPAN

Abstract

The H12 performance assessment (PA) provided a test for the robustness of a high-level radioactive waste (HLW) repository concept based on integrated siting and design, taking account of a wide range of potentially suitable Japanese geological environments (JNC, 2000). The assessment included a comprehensive evaluation of uncertainty and potentially detrimental factors, including perturbations due to external events and processes. Despite the lack of site-specific data that necessitated a broadly generic analysis for this initial stage of the Japanese programme, the safety case made is adequate for the intended objectives of the assessment: (1) analysis of sources and magnitude of uncertainties and the conservatism necessary to mitigate such uncertainties and (2) evaluation of the reliability and effectiveness of barriers and processes contributing to radionuclide isolation within the engineered barrier system (EBS) of the near field. This paper presents the EBS modelling for the H12 PA in terms of the results, conclusions and future priorities.

1. Introduction

In Japan, as outlined in the overall high-level radioactive waste (HLW) management programme defined by the Japanese Atomic Energy Commission (AEC, e.g. AEC, 2000), HLW from reprocessing of spent nuclear fuel will be immobilised in a glass matrix and stored for a period of 30 to 50 years to allow cooling. It will then be disposed of in a deep geological formation. The Japan Nuclear Cycle Development Institute (JNC) completed a second progress report (referred to as H12) on generic research and development for geological disposal of HLW in Japan and submitted it to the AEC in November 1999. The primary objective of H12, as specified in the guidelines published by the Advisory Committee on Nuclear Fuel Cycle Backend Policy of the AEC (AEC, 1997), is to present an outline of the technical reliability of geological disposal in Japan. It also provided input for the siting and regulatory processes, which would be set in motion after the year 2000.

Taking account of the technical achievements of H12, the “Specified Radioactive Waste Final Disposal Act” was promulgated in June 2000. Pursuant to the overall HLW management programme, thereby the Nuclear Waste Management Organization of Japan (NUMO) was established

with responsibility for implementing HLW disposal in October in the same year. NUMO is responsible for site selection and characterisation, demonstration of disposal technology, relevant licensing applications and repository construction, with the objective of starting repository operation by the 2030s (in any case, no later than the mid 2040s).

In H12, demonstration of technical reliability relies on two fundamental principles. Firstly, that a properly sited and designed repository with a robust engineered barrier system (EBS) is intrinsically safe because it avoids potential major disruptive processes and ensures that any releases of radionuclides in the far future will have no significant health effects. The second principle is that a performance assessment (PA) of the engineered and natural barrier system can demonstrate a wide margin of safety for the proposed disposal concept.

This paper overviews of the H12 performance study focusing on EBS modelling, results and conclusions and also discusses future priorities for the areas with larger uncertainties.

2. The geological disposal system

The concept of geological disposal in Japan is similar to that considered in other countries, being based on a system of multiple passive barriers consisting of the geological environment (geosphere) and the EBS (including vitrified waste, an overpack and low-permeability buffer material). The disposal site considered is generic, as neither host rock nor siting area has so far been identified. For PA, it is assumed that the repository is sited in a stable geological environment where no significant natural resources exist, that the repository is located at depth (between 500 and 1 000 m), and that a sufficient level of quality control of operational procedures is exercised. Such a repository, based on an integrated siting and design process, provides the following intrinsic safety functions (Umeki, 2000):

- Protection of the EBS by the geosphere (from physical and chemical perturbations);
- Long-term physical containment and chemical isolation of radionuclides by the EBS;
- Retardation and diffusion/dispersion of radionuclides by physical and chemical processes in both the EBS and the geosphere.

The generic nature of the host rock in the H12 assessment means that primary emphasis is placed on the performance of the near field, consisting of the EBS and the immediately surrounding host rock. Emphasis on the EBS is well justified by experimental studies of radioelement solubilities and PA calculations. These calculations, supported by laboratory tests and natural analogue studies, indicate that the key safety functions (e.g. diffusion-limited release of radionuclides, chemical buffering of porewater, retardation of short-lived radionuclides) of the bentonite-based buffer will be retained for a very long period ($>10^5$ years), provided an appropriate geological environment is selected. Since engineered barriers and associated near-field processes are, in general, characterised by less uncertainty than the geosphere (especially given the complex Japanese tectonic setting), relatively realistic near-field datasets and models were developed, although some moderately conservative assumptions were made.

3. The EBS design and its integrity

3.1 Reference EBS design

The EBS was designed with a high performance margin to cover the wide range of geological conditions found in Japan. The EBS consists of the vitrified HLW, a massive overpack for containment of the vitrified waste and a buffer that fills the gaps between the overpack and the surrounding rock. It should be noted that both “in-hole” and “in-tunnel” disposal, as in Figure 1, are considered in H12 and, although there is no difference in the dimensions of the EBS (hole and tunnel diameters, thus buffer thickness, are the same), these disposal options behave somewhat differently with regard to safety². Emplacement options can be selected flexibly or can even be combined, depending on the geological conditions at the site. A carbon steel overpack is used for most design studies and analyses but alternative materials (Ti-steel and Cu-steel composite overpacks) are also considered.

Figure 1. The engineered barrier system concept shown for the in-hole and in-tunnel disposal option for different types of the host rock. Waste package dimensions and buffer thickness are the same for the in-hole and in-tunnel disposal options

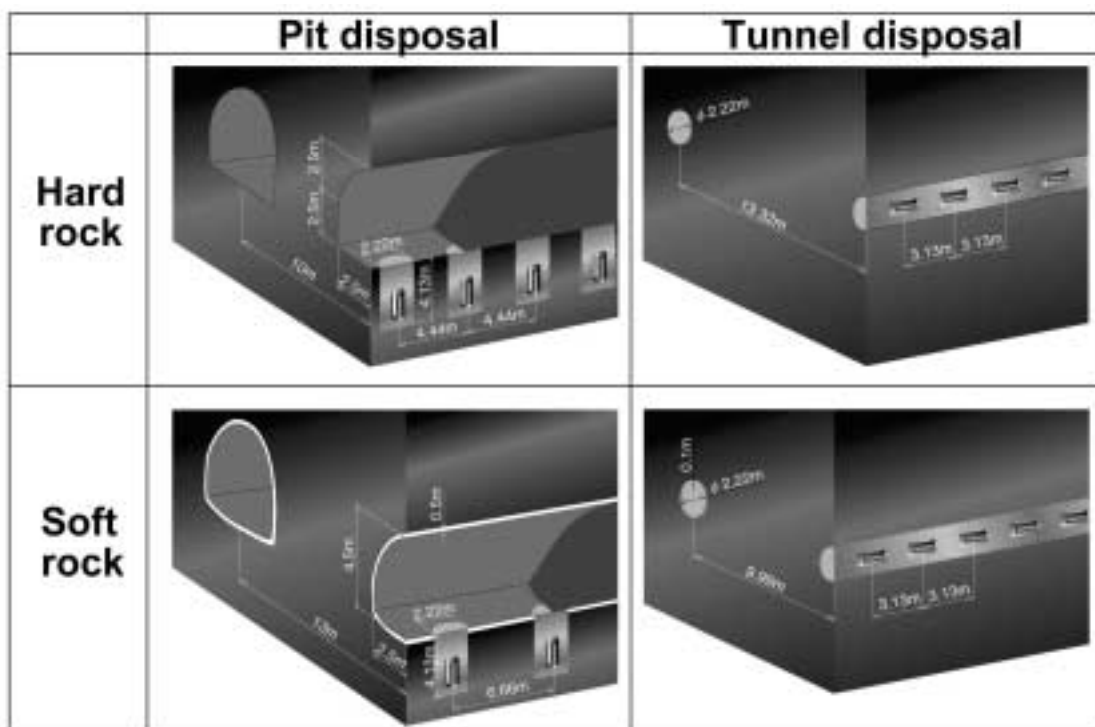

2. This is due to the role of the excavation disturbed zone (EDZ) as a pathway for radionuclides released from the bentonite. In the case of “in-hole” disposal, the disposal hole is excavated within the EDA of the large diameter access tunnel from which disposal is carried out. Thus the host rock adjacent to these disposal holes is likely to be more extensively affected than that around the single small diameter tunnels used for “in-tunnel” disposal. Other components (backfill) in vertical case are also not considered in PA

The in-tunnel horizontal emplacement method and the disposal hole vertical emplacement method were considered to provide a good contrast with one another and were selected as the reference options. In the PA, these options were considered to be equivalent, but this assumption is based on a lack of consideration of either the emplacement hole plug or the excavation disturbed zone (EDZ) of the large tunnel for the in-hole.

The dimensions of the various EBS components were established by an iterative analysis procedure. Key constraints were:

- the waste form heat output (from waste loading of Japan Nuclear Fuel Ltd. (JNFL) glass and assumed 50 year cooling time before disposal);
- the presence of void space in the fabrication waste package (from operational procedures);
- a desired overpack lifetime of at least one thousand years (to avoid requirements to quantify nuclide transport in the presence of significant thermal and water content gradients);
- a desire to keep the bentonite at temperatures below 100°C (to avoid possible loss of swelling properties, chemical alteration, etc.);
- specified rock thermal and mechanical properties.

The substitution of pure bentonite, used in H3 study (PNC, 1992), with a 70% bentonite/30% sand mixture improves some important properties such as thermal conductivity and rheology (giving less risk of overpack sinking or bentonite erosion), while retaining the critical roles for the buffer of filtering colloids, ensuring solute transport by diffusion only, chemical buffering and sorption of key radionuclides.

Calculations indicated that a total overpack thickness of 19 cm of carbon steel was sufficient to provide the required radiation shielding and more than sufficient to withstand the expected pressure at a depth of 1 000 m in hard rock or 500 m in soft rock, even assuming significant stress anisotropy, pressure from swelling of bentonite and overpack corrosion products, and allowing for 1 000 year corrosion in saline or fresh groundwater.

For the established EBS design, rock mechanical and thermal calculations were used to set the pitch of the emplacement tunnels and the waste packages, respectively (see also Figure 1). It is noticeable that the EBS design does not evaluate strictly implementation practicality – which could be problematic in either soft or hard rocks.

3.2 Integrity of the EBS

In order to confirm the performance of EBS after emplacement, the following items are analysed and evaluated in H12 based on the specifications for the disposal facility and EBS: EBS behaviour during resaturation of the buffer, long-term mechanical stability of the EBS, seismic stability of the EBS, migration behaviour of gas through the EBS and intrusion of buffer material into fractures. The results of these analyses are incorporated into H12 performance assessments.

1) *Resaturation*

The resaturation time (time to reach saturation in the buffer after emplacement of the EBS) due to the groundwater infiltration is an important factor in order to evaluate corrosion behaviour of the overpack and performance of the buffer after emplacement of the EBS. However, resaturation is just one of a number of time-dependent effects, including radiogenic heating and buffer swelling, which are not independent but can be strongly influenced by, and coupled with, each other. Evaluating these coupled thermo-hydro-mechanical phenomena in the near field is important in order to understand the initial transient behaviour of the EBS (NB: in swelling clays, additional coupled chemical processes can also be of significance).

To evaluate the coupled thermo-hydro-mechanical phenomena, an understanding of the mechanisms of each individual phenomenon is required. To achieve this, various types of tests have been conducted on heat transfer, water infiltration and swelling pressure of unsaturated bentonite (Suzuki *et al.*, 1996). In addition, a coupled thermo-hydro-mechanical model has been developed as part of the international projects “DECOVALEX” (Jing *et al.*, 1996) and “VALUCLAY” (Progress will be summarised in the SKB technical report series). Along with these projects, coupled thermo-hydro-mechanical tests, conducted at engineering-scale or full-scale, have been carried out to investigate the validity of the developed models (codes).

For example, a coupled thermo-hydro-mechanical experiment was carried out at the in-situ test site at the Kamaishi mine (Fujita *et al.*, 1998; Chijimatsu *et al.*, 1999a). The results of the experiment were compared with results of analyses conducted with a coupled thermo-hydro-mechanical model (Chijimatsu *et al.*, 1999b). There was a reasonable agreement between the two sets of results, confirming that the models can be applied in an assessment of the coupled thermo-hydro-mechanical phenomena.

An analysis was conducted for the disposal pit vertical emplacement concept in hard rock, using an axisymmetric model. The results show that the outer part of the buffer saturates at an early stage, within about 1 year, the middle part saturates in about 20 years and the inner part in about 50 years. Thus, even when the pressure head is low, for an intrinsic permeability of host rock of about 10^{-15} m^2 , resaturation occurs in about 50 years.

2) *Mechanical stability*

In the near field, as tunnels and pits are excavated, a redistribution of stresses in the surrounding rock will occur. For a long period of time after the emplacement of waste packages, swelling of buffer, settlement of the overpack under its own weight, deformation arising from expansion of overpack corrosion products and creep deformation of the rock mass will take place. The evaluation of the effects of these processes on the stress field in the buffer and host rock was then made in order to examine the long-term mechanical stability of the near field taking account of these various processes (Takaji *et al.*, 1999).

Figure 2 indicates the processes that may influence the stress state of the host rock, buffer and overpack over time and which were considered in the analysis. Each of the processes is assumed to have a continuous impact after the time indicated by an arrow.

Figure 2. Time sequence of processes considered in the near-field mechanical stability analysis

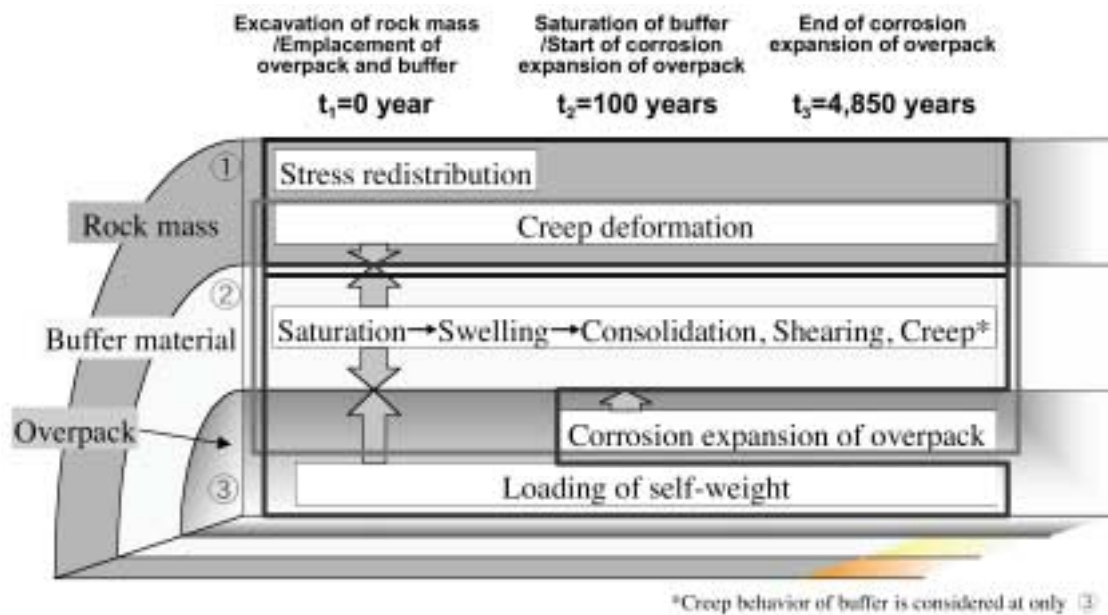

Three analyses were performed: rock creep, deformation from expansion of overpack corrosion products and the long-term sinking of the overpack due to its own weight. The results are summarised below.

Rock creep

The results show that, for the hard rock dataset, an elastic deformation of 1.5 mm is expected immediately after tunnels are excavated and essentially no creep deformation is expected to occur for the next 10 000 years. Moreover, calculations show no change over time in stress distribution. Thus, for the assumed hard rock dataset, the surrounding rock will remain stable for a long period of time after the excavation of tunnels.

For the soft rock dataset, elastic deformation resulting from the excavation of tunnels is calculated to be 7.8 mm at the crown and 9.0 mm on the side walls. Subsequent creep deformation is calculated to be 15.4 mm at the crown and 11.6 mm on the side walls after 1 000 years, and 21.8 mm at the crown and 15.9 mm on the side walls after 10 000 years. Accordingly, it is important in safety assessment to examine the possibility of the plastic zone spreading.

Overpack corrosion product expansion

The results of the analysis indicate that the maximum value for the stress ratio (shear stress/mean effective stress) after 10 000 years is about 0.60 for the hard rock dataset and about 0.49 for the soft rock dataset. In the hard rock system, the stress ratio is close to the critical state ($M=0.63$), but the zones in which the stress ratio is particularly large are limited to the peripheral area of the overpack. Therefore, the analysis shows that the engineered barrier system attains a comparatively stable state which persists for a long period of time.

Overpack sinking

The sinking after 10 000 years is predicted to be about 2.6 mm for the disposal tunnel horizontal emplacement concept and about 5.1 mm for the disposal pit vertical emplacement concept, where a heavier load is applied to the buffer. At longer times, the sinking of the overpack is predicted to cease. In other words, the decrease in thickness of the buffer due to the settlement of an overpack has a smaller impact than the expansion of overpack corrosion products. Based on the assumptions made in this model, it seems likely that overpack sinking will not have a significant impact on the long-term performance of the EBS.

As far as the processes analysed here are concerned, the physical property values and boundary conditions for modelling were conservatively set. Even so, the analyses confirmed that the EBS and the surrounding host rock remain mechanically stable over a long period of time (up to 10 000 years). To upgrade models in the future and to prepare more realistic combined analytical techniques, it is important to acquire long-term data for the behaviour of the host rock and buffer materials which affects the long-term structural stability.

3) Seismic stability

In order to maintain the integrity of EBS after emplacement, it is necessary for it to remain in a stable condition during dynamic earthquake perturbations. In particular:

- The overpack must not move significantly due to the inertial force of the overpack.
- The buffer must not reach a shear failure condition from the stresses caused by an earthquake.
- The support ability of the buffer for the overpack must not be damaged by earthquake-induced perturbation in the porewater pressure within the buffer (i.e. liquefaction).

Confirmation of the above items by engineering-scale vibration tests of simulated engineered barriers is necessary because of the prevalence of earthquakes throughout much of Japan.

In order to assess the seismic stability of the engineered barriers, seismic response analytical codes were developed. In parallel, vibration tests were conducted by the National Research Institute for Earth Science and Disaster Prevention on one-tenth and one-fifth scale models of the engineered barriers using small and large shaker tables (Mikoshiha *et al.*, 1995, 1996). Tests were carried out assuming two cases: i) a dry condition of the buffer immediately after the emplacement of the EBS and ii) a wet condition in which groundwater penetrates the buffer. The mathematical model used in the analytical codes was verified by comparison with the results of these tests (Taniguchi, *et al.*, 1999).

The seismic stability in the near field, involving the full-scale EBS, was analysed by considering the dynamic stability of the buffer. The results of the total stress analysis indicate that the overpack and buffer show almost the same vibration behaviour and hence the EBS behaves as a rigid body. Viewed from the perspective of dynamic stability of the buffer during an earthquake, it is confirmed that there is little possibility of shear failure within the buffer due to an earthquake. The effective stress (two-phase system) analysis made for the saturated EBS found that there was no rise in the porewater pressure in the buffer, so that the possibility of liquefaction is remote.

4) *Gas migration*

In a reducing environment in a deep underground repository, carbon steel overpacks are expected to corrode, generating hydrogen. The hydrogen is assumed to initially dissolve in the porewater in the buffer and then diffuse or migrate through the buffer. If the amount of hydrogen discharged by diffusion is less than the generation rate, a separate hydrogen gas phase may accumulate between the buffer and the overpack. As more gas accumulates, the pressure could affect the stability of the surrounding buffer and host rock. The migration of hydrogen gas might also displace radionuclide-bearing porewater from the buffer.

A gas-water migration analysis was carried out to evaluate the migration behaviour of hydrogen gas and water, pore pressure, saturation, etc (Tanai, *et al.*, 1999). In the analysis, the corrosion rate of the carbon steel overpack was assumed to be a relatively high value of $10 \mu\text{m y}^{-1}$ in order to conduct a conservative evaluation.

The flow of hydrogen gas through the buffer starts at 3 to 20 years after the initiation of gas generation, and the release of gas into the host rock starts after about 30 years. The water saturation after gas flow initiates is 96 to 98% overall. It was also confirmed that the steady-state rate of hydrogen gas migrating from the buffer into the rock mass is equal to the gas generation rate ($0.23 \text{ m}^3 \text{ y}^{-1}$) at STP and essentially all of the generated hydrogen gas migrates into the surrounding host rock.

Analytical results for the horizontal emplacement concept in hard rock system (1 000 m depth) are comparable with those for the vertical emplacement concept in soft rock system (500 m depth), apart from differences arising from disposal depths: start of infiltration of the generated hydrogen into the buffer and the surrounding host rock, and pressure and discharge rate of porewater.

Based on these results, it is expected that almost all the generated hydrogen will migrate as gas into the surrounding host rock and will not affect the stability of the buffer and host rock or radionuclide migration.

5) *Extrusion of bentonite*

As a result of swelling, buffer material may intrude into the surrounding rock. If sustained for an extremely long period of time, buffer material extrusion could lead to reduction of buffer density, which may in turn degrade the assumed performance assessment properties. An experimental study of this behaviour and a theoretical analysis were both conducted.

Building on earlier analyses (Pusch, 1981, 1983; Kanno and Wakamatsu, 1991; Börgesson, 1990; Ahn, 1999), the intrusion of buffer materials into fractures in the rock mass was analysed using a finite element method and a diffusion model. It was found that the reduced density of the buffer material inside the disposal drift due to penetration of the buffer into the fractures in the rock was still about 96% of the initial value over a period of one hundred thousand years; after one million years, the buffer material density was still at about 89% of the initial density. Based on these results, it is believed that the density of the buffer material does not change significantly over a long period of time and that the performance characteristics and functions of the buffer will be maintained.

These analyses to demonstrate the EBS integrity may be necessary to improve the assessment method, and, once the disposal site is selected, to conduct a site-specific assessment using the specific geological and environmental conditions at the candidate repository site.

4. The long-term performance of the EBS

4.1 *Scenarios and calculation cases*

While the main safety functions of the repository are intrinsic to the design and location within a deep geological system, understanding the level of robustness of the proposed system in various geological conditions or under changes in system conditions can only be evaluated through long-term repository performance evaluation. An assessment method has been developed and applied in H12 to evaluate the safety functions and the level of robustness of the proposed system under various conditions.

The H12 safety assessment considered a range of disposal systems, including different possible geological and surface environments and repository designs. Furthermore, the effects of various sources of uncertainty on system performance were considered. This leads to a potentially very large number of cases if all combinations of geology, surface environment and repository design are considered. Thus it was necessary to establish a Base Scenario and Reference Case, around which sensitivity analyses were performed deterministically, in order to reduce the cases considered to a realistic number.

- The assessment consisted of the following steps: Development and application of a systematic methodology to ensure that the relevant features, events and processes³ (FEPs) were fully taken into account in developing scenarios for the assessment.
- Definition of a Base Scenario and, within this scenario, definition and quantitative analysis of a Reference Case and alternative cases.
- Definition of a range of isolation failure scenarios and alternative (“perturbation”) groundwater scenarios for either quantitative or qualitative analysis.
- Indication of key phenomena and uncertainties from the results of these analyses.
- Overall assessment of the system performance in a range of geological and surface environments, particularly with respect to the feasibility of safe geological disposal in Japan.

A Reference Case is defined for the Base Scenario, incorporating a particular set of geological characteristics, design features, model assumptions and parameter values. The nuclide transport pathways considered in the Reference Case are illustrated in Figure 3. Alternative cases are also defined for the Base Scenario (with alternative geological settings, design features, model assumptions or parameter values) and for perturbation scenarios.

3. Features, events and processes are the building blocks of scenarios. Hence the Base Scenario, in which radionuclides are released from the EBS and transported by groundwater through the geosphere, involves a large number of FEPs including the description of the EBS and geosphere (“features” of the system) and “processes” such as overpack corrosion, waste matrix dissolution and transport of the dissolved radionuclides through both the bentonite and the rocks of the geosphere. ‘Transport’ includes the physical processes of diffusion and advection as well as chemical processes such as sorption, precipitation and dissolution of nuclides.

For the Reference Case, the lifetime of the overpack of at least 1 000 years is assured by general corrosion of a thick carbon-steel overpack, which precludes perturbations from radiogenic heat and radiolysis in the analysis of radionuclide dissolution and migration through the EBS. Following breaching, the overpack is conservatively assumed to offer no resistance to water ingress or radionuclide egress; credit is, however, taken for the redox buffering effects by the corrosion products.

Figure 3. **Groundwater scenario Reference Case and conceptual models for radionuclide migration**

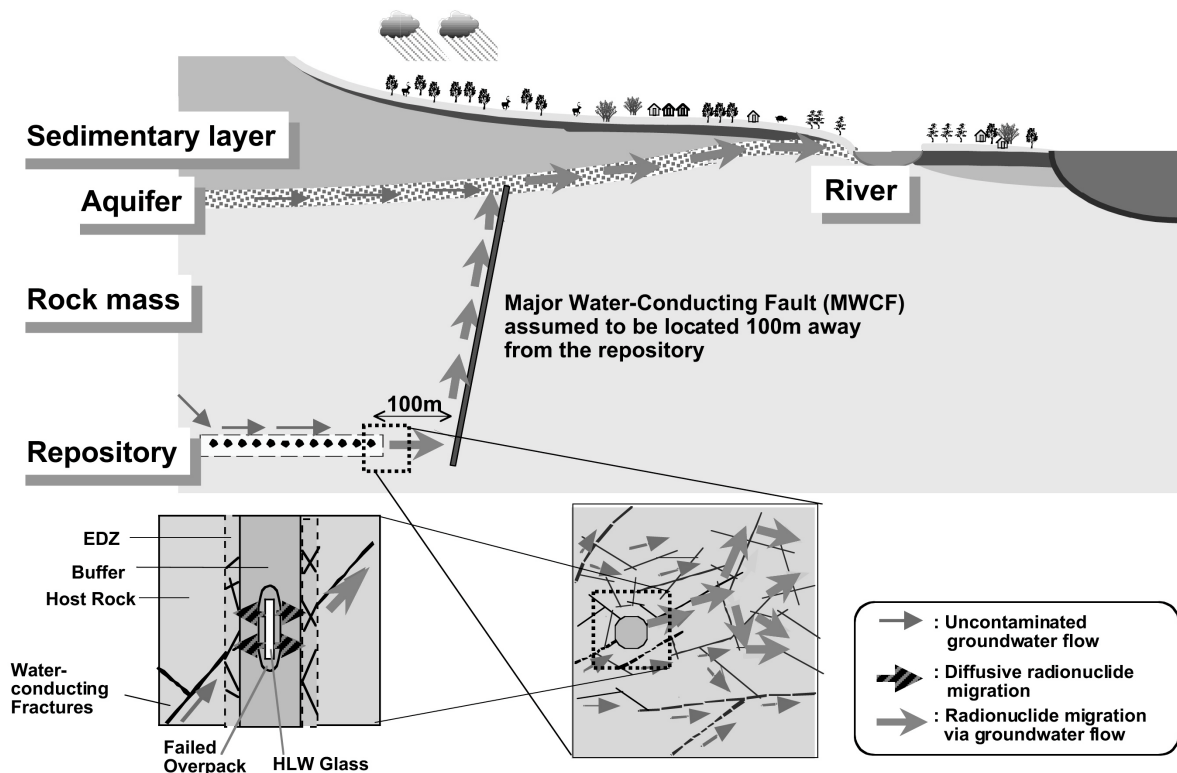

The long-term dissolution rate obtained experimentally for glass dissolution is used at the waste glass-buffer interface. The assumption of silica saturation is justified by the expected slow rate of transport of silica into the surrounding buffer. Radionuclides are assumed to be congruently dissolved with glass and solubility limits for all key radioelements, with the possible exception of Cs, are reached rapidly (~ few years) at the glass surface. Shared solubilities and the possibility of precipitation of radionuclides during migration of actinide chain nuclides through the buffer are also evaluated. Radionuclide solubilities for the near-field environment are derived using input from geochemical modeling and experimental measurements. Co-precipitation effects are considered for some elements (e.g., Ra).

4.2 Models and database

Based on a list of feasible scenarios, models which simulate relevant phenomena in detail, together with associated databases, were established in order to quantify selected scenarios. Models were developed to simulate the evolution of the EBS and subsequent radionuclide migration in the

rock surrounding the buffer material. These models are more detailed and realistic than those used in the earlier H3 assessment and thus improve our understanding of key processes. The same can be said of the corresponding databases.

The main radionuclide transport model used to represent EBS performance is based on one-dimensional diffusion with linear, reversible and instantaneous sorption. Distribution coefficients can be determined from batch studies with uncompacted buffer material, or can be calculated from measured values for element-specific diffusion coefficients from compacted samples; the latter values are used in H12 because they reflect more realistic conditions in the EBS.

The impact of variations in parameter values for mass transport through buffer on release to the far field is strongly affected by the boundary conditions. In H12, the diffusive flux from the buffer is balanced against the flux in groundwater flow through the excavation disturbed zone, as a more realistic model based on integrated siting and design. The calculated dose result for the Reference Case indicates that sufficient containment and isolation of radionuclides can be achieved by the EBS and the near-field host rock, provided the host rock continues to provide a stable environment for the operation of the EBS, and that the repository facilities are adequately designed and constructed (e.g. such that backfilling is complete and repository seals are effective).

Models and datasets for EBS modelling in H12 are derived from, and tested against, the results of an extensive laboratory experimental programme in Japan. In particular, use is made of engineering-scale experiments at the ENTRY facility, as well as radiochemical experiments under controlled repository-simulated conditions at the QUALITY facility. International scientific literature and international validation projects (e.g. OECD/NEA and SKI, 1994; Ota *et al.*, 2001) are also utilised. Natural analogue studies are also used to confirm the expected long-term performance of the key engineered barriers and near-field processes. For example, analyses of degradation of volcanic glasses in various environments are utilised to support the low degradation rates for the borosilicate glass waste form.

4.3 *Effectiveness and robustness of the EBS*

The long containment times of radionuclides within the multiple barriers provided by the disposal system means that most decay to insignificant levels before reaching the human environment. The decrease in the radiotoxicity of the contained radionuclides as a function of time was illustrated by means of a safety indicator termed the radiotoxicity index. The radiotoxicity index of a specific radionuclide within a specific system component has units of m^3 and is here defined as the inventory of that nuclide within the component (in Bq) divided by the maximum permissible activity concentration for that radionuclide outside a designated monitored area (in Bq m^{-3}) (STA, 1988). The “yardstick” was the radiotoxicity index of $5 \times 10^5 \text{ km}^3$ granite (which corresponds roughly to the volume of rock above the area occupied per waste package- check this number!) with 1 ppm natural uranium concentration.

Figure 4 shows the combined radiotoxicity index of all radionuclides in different system components as a function of time for the H12 Reference Case. The figure shows the substantial decay of radiotoxicity with time. The figure shows that radiotoxicity is contained predominantly within the engineered barriers of the repository at all calculated times. Only at times of around 10^6 to 10^7 years is a significant proportion of the total radiotoxicity present within the geosphere, by which time it has decayed by 5 orders of magnitude. The radiotoxicity of releases to the geosphere is always less than the natural radiotoxicity of $5 \times 10^5 \text{ km}^3$ of granite. At no stage is a significant proportion of the radiotoxicity present in the biosphere.

Figure 5 shows the maximum dose and the contributions of Cs-135 (dominant radionuclide for the maximum dose for the Reference Case) and Th-229 (high radiotoxicity daughter of Np-237 and dominant after about 5 million years for the Reference Case) as functions of transport distance in the undisturbed host rock expressed in terms of resultant dose which is calculated by introducing the radionuclide flux at that distance directly into the Reference Case biosphere. The dose decreases sharply as transport distance increases and becomes two orders of magnitude smaller within the first ten meters, illustrating the efficiency of the near-field host rock barrier for these nuclides.

Figure 4. **The combined radiotoxicity index per waste package of all radionuclides in different system components as a function of time for the H12 Reference Case**

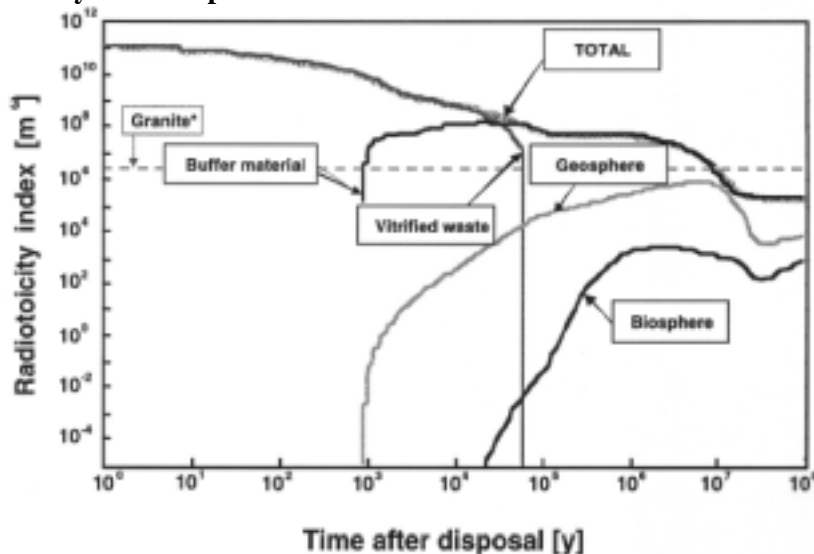

* $5 \times 10^{-5} \text{ km}^3$ of granite with 1 ppm uranium concentration which corresponds roughly to the volume of rock above the occupied area of a waste package

Figure 5. **Maximum dose for various transport distances (40 000 waste packages)**

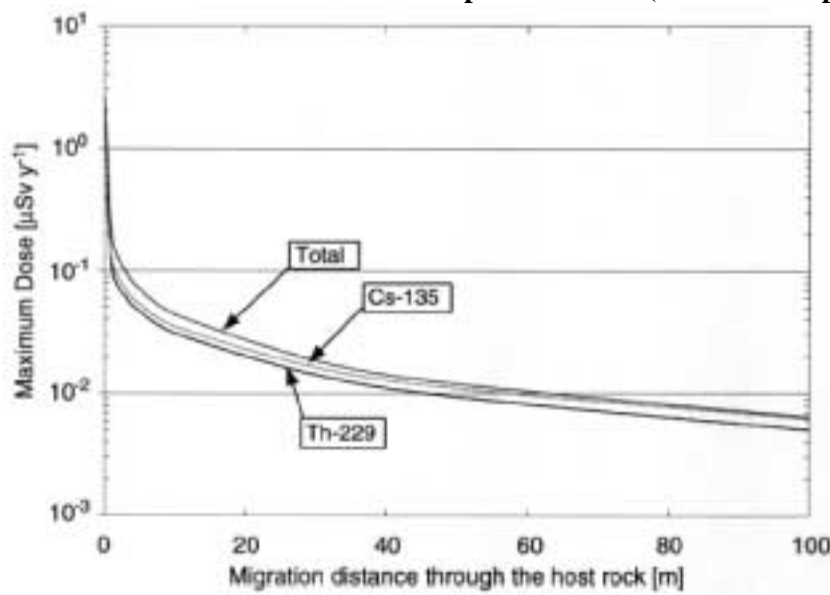

4.4 *Sensitivity and uncertainty analyses*

Model and data uncertainty cases were analysed by considering a wide range of alternative models and parameter values. In addition, a number of calculation cases have been conducted for scenarios in which the geological disposal system is perturbed in the future by natural events and human activities. Based on the understanding of system sensitivity acquired through these calculations, a set of cases focusing on the key factors has been analysed for self-consistent combinations of alternative geological environments and designs. Due to effects of uncertainties in models and data, alternative disposal systems and unlikely disruptive events, calculated values of the maximum annual dose vary significantly. However, none of them exceed the radiological protection levels proposed in foreign regulatory criteria or guidelines (100-300 $\mu\text{Sv y}^{-1}$).

5. **Key uncertain areas and future priorities**

In future stages of the Japanese programme, the engineered barriers will be optimised based on consideration of site-specific geological data obtained during site characterisation, and enhanced understanding of safety-relevant phenomena obtained by laboratory studies. This will allow more realistic modelling to be carried out in PA, although some uncertainty will remain and a degree of conservatism will still be included in order to ensure that confidence in safety margins can be derived from PA findings.

The identified key uncertain areas are:

- Studies on the transient phase following emplacement
 - Treatment of T-H-M-C-B coupled processes.
 - Perturbation by repository construction and operation.
 - Monitoring and QA strategy to justify the initial conditions for post-closure PA.
- Long-term alteration of buffer material
- Development of more reliable datasets, e.g. on characteristics of buffer material interactions with saline groundwater
- Characterisation of near-field geological conditions
 - Treatment of spatial heterogeneity, especially groundwater flow through the EDZ.
- PA methodology for the whole repository system, taking into account, e.g. the geometric complexity within the repository and effects of multiple sources

Closer linkages between repository design, site characterisation and PA will also be needed.

6. **Conclusions**

The results of various R&D activities have been integrated to develop a safety case within the H12 project to demonstrate the technical reliability and safety of the Japanese geological disposal concept. The basic argument that the proposed repository system is safe is based on functions intrinsic to the design, including barrier functions of the engineered system and the geosphere. To support the selection of potential sites, a methodology for safety assessment has been developed which focuses on the performance of the near-field. This methodology consists of developing relevant scenarios and realistic models, along with appropriate data, with a view to establishing the constraints on sites to be selected in the future which will ensure that safety guidelines are met.

The methodology developed in the H12 project provides a basis for the performance assessment of a geological disposal system at a site to be selected in the future. At the site-specific stage it will be important to incorporate realistic geological features and optimised engineered barriers without compromising the robustness in the methodology that is essential to a defensible assessment.

References

- AEC (1997): Atomic Energy Commission of Japan: Guidelines on Research and Development Relating to Geological Disposal of High-Level Radioactive Waste in Japan, Advisory Committee on Nuclear Fuel Cycle Backend Policy.
- AEC (2000): Long-term Program for Development and Utilization of Nuclear Energy, Atomic Energy Commission of Japan (in Japanese).
- Ahn, J. (1999): Long-Term Behavior of Bentonite Buffer in a Geologic Repository for High-Level Wastes, UCB-NE-4222.
- Chijimatsu, M., Sugita, Y., Fujita, T. and Amemiya, K. (1999a): Coupled Thermo-Hydro-Mechanical Experiment at Kamaishi Mine, Technical Note 15-99-02, Experimental results, JNC TN8400 99-034.
- Chijimatsu, M., Fujita, T., Kobayashi, A. and Ohnishi, Y.(1999b): Coupled Thermo-Hydro-Mechanical Experiment at Kamaishi Mine, Technical Note 16-99-03, Analyses of Task 2C, DECOVALEX, JNC TN8400 99-031.
- Fujita, T., Chijimatsu, M. Sugita, Y. and Amemiya, K. (1998): Field Experiment of Coupled T-H-M Processed in the Near Field, 1998 International Workshop, Key Issues in Waste Isolation Research, Barcelona.
- Jing, L., Stephansson, O., Tsang, C-F. and Kautsky, F. (1996): DECOVALEX -Mathematical Models of Coupled T-H-M Processes for Nuclear Waste Repositories, Executive Summary for Phases I, II and III.
- JNC (2000): H12: Project to Establish the Scientific and Technical Basis for HLW Disposal in Japan, Project Overview Report and three Supporting Reports, JNC TN1410 2000-001~004, 2000.
- Kanno, T. and Wakamatsu, H. (1991): Experimental Study on Bentonite Gel Migration from a Deposition Hole, Proc. 3rd Int. Conf. Nuclear Fuel Reprocessing and Waste Management (RECOD '91), Sendai.
- Mikoshiha, M., Ogawa, N. and Miwa, T. (1995): Research on the Vibration Behavior of Deep Underground Cavities and Structures, Science and Technology Agency, FY 1995, National Organization for Atomic Energy Test Research, Progress Report, No.34 pp.21-1-21-6 (in Japanese).
- Mikoshiha, M., Ogawa, N. and Miwa, T. (1996): Research on the Vibration Behavior of Deep Underground Cavities and Structures, Science and Technology Agency, FY 1995, National Organization for Atomic Energy Test Research, Progress Report, No.35 pp.19-1~19-6 (in Japanese).
- OECD/NEA and SKI(1994):GEOVAL'94 Validation Through Model Testing, Proceeding of an NEA/SKI Symposium, Paris, France, 11-14 October 1994; Ota, K., Alexander, W.R., Smith, P.A., Möri, A., Frieg, B., Frick, U., Umeki, H., Amano, K., Cowper, M.M. and Berry, J.A. (2001): Building confidence in radionuclide transport models for fractured rock: the Nagra/JNC Radionuclide Returdatation Programme. Sci. Basis Nucl. Waste Manag. XXIV, pp. 1033-1041.
- NEA/SKI Symposium Paris, France, 11-14 October 1994.

- PNC (1992): Research and Development on Geological Disposal of High-Level Radioactive Waste: First Progress Report (H3), PNC TN 1410 93-059.
- Pusch, R. (1981): Borehole Sealing with Highly Compacted Na Bentonite, SKBF/KBS Technical Report 81-09.
- Pusch, R. (1983): Stability of Bentonite Gels in Crystalline Rock-Physical Aspects, KBS TR83-04.
- STA (Science and Technology Agency) (1988): Notification No.20 (in Japanese).
- Suzuki, H., Fujita, T. and Kanno, T. (1996): Water Potential and Water Diffusivity of Buffer Material, PNC TN8410 96-117 (in Japanese).
- Takaji, K., Sugino, H., Okutsu, K., Miura, K., Tabei, K., Noda, M., Takahashi, S. and Sugie, S. (1999): Evaluation of Long-Term Mechanical Stability of the Near-Field, JNC TN8400 99-043 (in Japanese).
- Tanai, K., Sato, H., Murakami, T. and Inoue, M. (1999): A Preliminary assessment of Gas Diffusion and Migration, JNC TN8400 99-045 (in Japanese).
- Taniguchi, W., Takaji, K., Sugino, H. and Mori, Y. (1999): Evaluation of Seismic Stability of the Near Field, JNC TN8400 99-054 (in Japanese).
- Umeki, H. (2000): Key Aspects of the H12 Safety Case, MRS 2000, 24th International Symposium on the Scientific Basis for Nuclear Waste Management, August 27-31, 2000, Sydney, Australia.

**ON-GOING ACTIVITIES OF THE EC PROJECT “BENIPA”
CURRENT STATUS, KEY ISSUES AND ACHIEVEMENTS**

Jesús Alonso
ENRESA, Spain

Abstract

BENIPA (Bentonite Barriers in Integrated Performance Assessment) is a research project, within the Fifth Framework Programme of the European Union, which was started on September 2000 and has a duration of 36 months. Participants in the project are: 2 National Agencies, which are responsible for national HLW management (ENRESA as Project Co-ordinator, Spain and NAGRA, Switzerland) and 6 Research Centres (GRS, Germany; IRSN, France; NRG, The Netherlands; SCK•CEN, Belgium; VTT, Finland and ZAG, Slovenia).

The overall objective of BENIPA is to assess the state of the art in the treatment of bentonite barriers in Integrated Performance Assessment, evaluating the capacity and consistency of methods and data available to convincingly justify the capacity of bentonite to perform their assigned safety functions.

During the first part of the project different bentonite barrier concepts have been reviewed and four reference cases have been defined for the modelling work in the project. FEP's Databases have been created and the scientific and technical bases for the analysis of bentonite barriers have been reviewed. In the second part of the project, as a step previous to modelling, an analysis of models for the mechanical, hydrological, thermal and chemical conditions is carried out, along with a review of the needs in input data.

In BENIPA, calculations at process and integrated level are currently being performed among different codes to check consistency and sufficiency or complementarily for fulfilling the needs of performance assessment. However, since it is too early to present some of the results or even the individual contributions of the partners, the modelling and calculations being currently carried out by ENRESA will be advanced, just as a representative example of the work going on.

This paper summarises the work already done in BENIPA and provides with illustrations of the modelling work consisting of the approach followed by ENRESA in applying three codes: CODE_BRIGHT, CORE^{2D} and GOLDSIM. The processes considered, simplifications adopted, limitations imposed and preliminary findings of the work are mentioned along.

1. Introduction

The engineered barriers in the near-field of most repository concepts for high level wastes and spent fuel, in crystalline and clay host rocks, call for the use of significant amounts of bentonite based materials (hereafter called bentonite barriers) interposed as a buffer between the waste packages and the host rock.

Considerable resources and time has been and is being devoted to the study and testing of bentonite barriers, focusing alternatively on diverse aspects at different levels of detail, and different scale and time horizons. This effort is being pursued in a continuous process for confidence building and optimisation, justified by the importance of bentonite barriers for the safety, and for the design, operation and closure of the repository systems. The increasing body of knowledge and multiplication of methods and tools of assessment available strongly outline the need of an overall analysis of the achievements and trends in respect of what is needed and/or desirable in this field.

On the other hand, the behaviour of bentonite barriers in the repository environment is influenced by mechanical, hydrological, thermal, chemical and radiological conditions, which are variable in both time and space. However, integrated performance assessment should assume a more or less large degree of abstraction and simplifications due to:

- Difficulty to account for heterogeneity and variability along the space and time.
- Uncertainty in some of the input data for the models.
- Difficulty to model some significant processes (gas flow, colloids, THMC coupling, etc.)

To assess all these topics several European countries have integrated their skills, knowledge and experience in a project. BENIPA (Bentonite Barriers in Integrated Performance Assessment) is a research project, within the Fifth Framework Programme of the European Union, that focuses on the role of bentonite barriers in the performance of deep repositories for the disposal of spent fuel and vitrified high-level waste in granite and clay formations.

BENIPA was launched on September 2000 and has a duration of 36 months. Participants in the project are 2 national agencies and 6 research centres. ENRESA is the Co-ordinator of the Project.

Table 1. **Participants in BENIPA**

Country	Partner	Profile
Spain	ENRESA	National Agency
Switzerland	NAGRA	National Agency
Belgium	SCK·CEN	Research Institute
Finland	VTT	Research Institute
France	IRSN	Research Institute
Germany	GRS	Research Institute
Netherlands	NRG	Research Institute
Slovenia	ZAG	Research Institute

The project is structured in work-packages (WP), which cover: from the state of the art and knowledge available regarding bentonite barriers to the analysis and comparison of specific results obtained using different models. The different work packages and tasks are developed in parallel for repositories in clay and in granite.

- WP1 is a review of the bentonite barrier concepts and their role in repository safety on the base of former performance assessment conclusions [2]. Also, the reference cases for the calculations are selected [3].
- WP2 compiles two list of FEP's, one for clay and one for granite [4], and describes the scientific and experimental bases for the bentonite barriers [5].
- WP3 gives a detailed analysis of the different models and computer codes used at detailed process level and at integrated level [6]. Input data for the models are generated and justified [7]. The focus of the analysis is on the conceptual consistency among the different models and their complementarily and sufficiency for fulfilling the needs of Integrated Performance Assessment.
- In WP4 calculations are performed at process and at integrated level with improved methods to evaluate the significance of processes and scenarios. Sensitivity and optimisation analysis are also part of this work package.
- WP5 consists of the co-ordination and integration work along the project, and the evaluation of the results and the derivation of overall conclusions.

WP1, WP2 and most of WP3 have been finished during the first part of the project. BENIPA is currently immersed in WP4. Calculations at process and integrated level are being performed among different codes to check consistency and sufficiency or complementarily for fulfilling the needs of performance assessment. However, it is too early to present in this paper the final results or even the individual contributions of the partners; the modelling and calculations being currently carried out by ENRESA, referred to its own repository concept, will be introduced in the following, just as a representative example of the work to come.

The codes used by ENRESA are CODE_BRIGHT, CORE^{2D} and GOLDSIM. The processes considered, simplifications adopted, limitations imposed and preliminary findings of the work are mentioned along.

2. Project description. Process and model analyses

The first half of the project was dedicated to compile the relevant information, to generate project FEP databases and to analyse the basic data and available models for the assessment of bentonite barriers.

A synthesis of the engineering concepts using bentonite as a barrier in repositories in both crystalline and clay rock has been carried out. The design functions summarised for bentonite barriers are the following:

- Stabilise and support openings and reduce shearing forces on containers.
- Seal rock fractures and fissures.
- Allow canister emplacement keeping the canister in position.
- Provide a chemical environment, minimising container corrosion and radionuclide solubility.

- Provide a low-hydraulic conductivity around the canister.
- Retard the diffusion-controlled transport of many dissolved radionuclides.
- Filter colloids that may be form in the inner space of the barrier.
- Allow release of gas produced by metal corrosion and heat transfer from the canister to the rock.

Four reference cases have been defined for subsequent modelling and calculating activities. They are based on specific concepts from existing programs for both the granite and clay options. Two reference cases have been selected within granite repository concepts. These are the vertical hole emplacement and the tunnel emplacement options. The reference case for the vertical hole emplacement is based on the KBS-3 repository design whereas for tunnel disposal it is that of ENRESA (FEBEX) concept. For the clay two different options have been selected too, one for “stiff” clay and the other for plastic clay, both with a tunnel design. The reference case for a repository in mudrock is from NAGRA, whereas the reference case for the plastic clay is from NIRAS/ONDRAF.

Regarding the process analysis, a compilation and elaboration of FEP’s relevant for the performance of bentonite barriers has been produced for the granite and clay options and compared with the NEA International FEP’s Database and some national databases. FEP Databases in BENIPA try to avoid typical problems sometimes found in other FEP Databases as: lack of consistency in the level of discrimination between FEP’s, redundancies and overlapping, and excessive generality or, on the contrary, excessive detail in the descriptions. The approach adopted is based on a systematic, hierarchical structure

Also, a project handbook of relevant data for safety assessment of bentonite barriers, with appropriate references for usage in the project has been produced. To this aim, a significant amount of data was compiled covering the knowledge on bentonite barriers obtained in laboratory, rock laboratory, in situ experiments, natural analogues theoretical studies and reviews. The information obtained is collected in more than one hundred cards, summarising work carried out in all the countries involved in BENIPA, and in Sweden, in Canada and in Japan. The following are some illustrative examples of important issues identified in this document.

- The problem of isolating the “true” porewater, to obtain reliable data on pore water chemistry in very low permeable and scarce water-content clay systems, has not been solved yet. Modelling of the pore water is proposed as a means to obtain representative pore water chemistry at initial conditions instead of using the chemical compositions of the pore water obtained in tests for high solid to liquid ratios (squeezing and seep water).
- In transport models bentonite parameters are assumed to be constant along the time. The long-term effects of heat and radiation on bentonite transport parameters are not well known.
- For the time being, tests performed in odometers have not permitted good dimensional control of bentonite samples. As a consequence, fictitious saturation degrees over 1 have been obtained. New tests performed at different temperatures are required to describe the thermal effects on retention curves.
- Kd values in batch experiments are not representative for compacted bentonite. Preferred transport parameters to measure are De and Da.

On the other hand, BENIPA carries out an analysis and cross comparison of the different models available for the numerical simulation of the behaviour of bentonite barriers. Also, the capacity

of characterisation methods and measuring techniques to satisfy input requirements of the models is evaluated.

The analysis provides an overview of the process level models and integrated level models that are used in BENIPA. The potential roles of these models in performance assessment and in particular their consistency, complementarity and applicability have been investigated.

Aspects such as the theoretical bases on which specific models are built and their past uses have been extensively covered. Similar models and codes were compared to assess whether the models cover the FEP's identified in BENIPA and to identify possible roles of these codes in performance assessment. Fourteen computer programs have been considered in BENIPA.

Table 2. **Classification of codes used in BENIPA**

BENIPA MODELS				
C O D E S U S E D	Integrated level	Process level		
		Mapping of FEP's		
		T-H-M	Transfers in porous media	Reactive transport
	CHETMAD GOLDSIM GRAPOS REPCOM STMAN			
	MELODIE PORFLOW	CODE_BRIGHT CAST3M FLAC ^{3D} FLAC	PORFLOW TOUGH2 CORE ^{2D}	CORE ^{2D} HYTEC

Some of the codes are commercial but others have been developed within national programmes and the developers either participate in the project or are available for consultation.

3. Project description. Modelling and calculations

Modelling and calculations are being carried out, at process level and integrated level for both normal evolution and other specific scenarios, on the BENIPA reference cases. The results are being analysed and compared from the point of view of consistency and complementarity of the available models. The purpose of detailed process level is to investigate the significance of specific phenomena and to provide inputs to other calculations, namely at integrated level, so that they can support the initial assumptions and provide the bases for selecting input data. A second set of calculations will be performed and their results analysed to investigate the sensitivity and margins of optimisation of bentonite barrier performance. Sensitivity and optimisation analysis will include three types of calculations, namely: local sensitivity analysis, global sensitivity analysis and optimisation analysis.

The calculations at process level address the following main phenomena:

- thermal processes;
- mechanical processes;
- hydraulic processes;
- geochemical processes;
- transport by colloids;

The scenarios being considered in BENIPA are:

- normal evolution scenario;
- altered evolution scenarios:
 - migration in a post emplacement (pre-closure phase);
 - transport of radionuclides in case of accidental drilling (includes modelling the behaviour of a hole in the barrier in case of accidental drilling);
 - early canister failure, taking into account the transient temperature field.

As was previously indicated in the Introduction, no final WP4 calculations are yet available. Preliminary calculations carried out by ENRESA are referred here just as illustrative examples. In the following only the modelling of the tunnel concept in granite case will be presented.

In ENRESA reference case for tunnel emplacement in granite the fuel elements are incorporated in cylindrical carbon steel canisters measuring 4.54 m in length and 0.90 m in diameter. The canisters are emplaced in cylindrical receptacles, constructed with blocks of compacted bentonite inside horizontal drifts, measuring 500 m in length and 2.4 m in diameter. A separation of 2 m between canisters has been established, and of 35 m between disposal drifts, in order not to exceed a temperature of 100°C in the bentonite.

Figure 1. **Reference case for granite – tunnel emplacement**

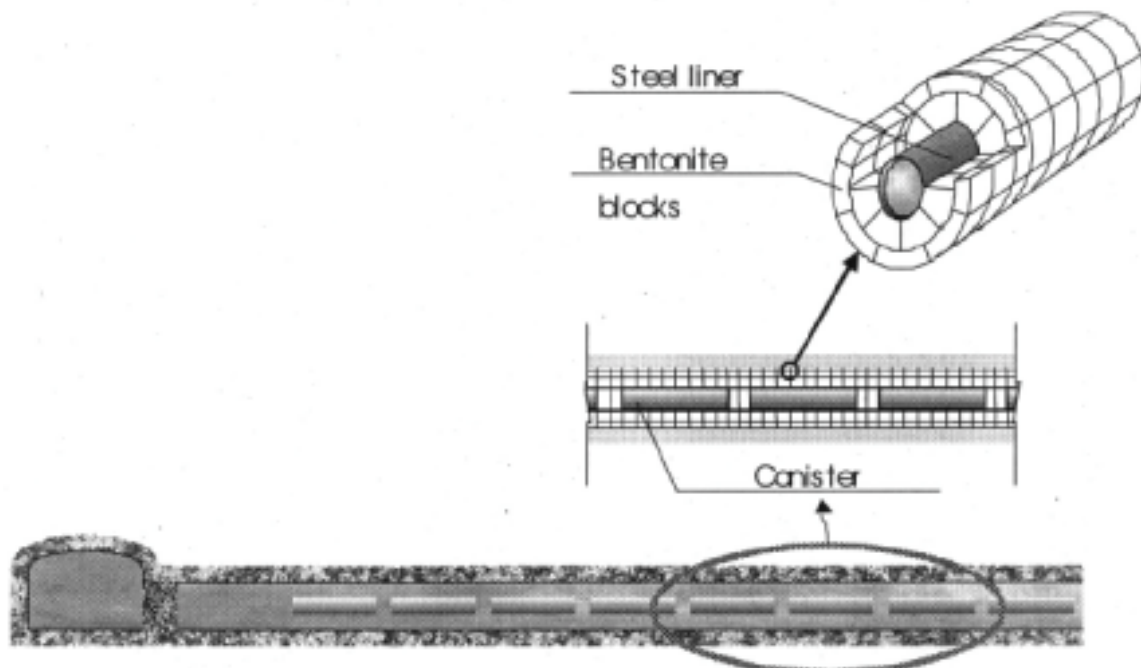

3.1 ENRESA's T-H-M modelling

Evaluation of repository evolution involves consideration of coupled processes induced by the changes in thermal, hydrological and mechanical conditions. ENRESA's aims for the T-H-M calculations are:

- Predict the evolution of the temperature and water saturation. The temperature in the buffer should remain below the limit of 100°C to avoid boiling in the unsaturated phase and to reduce the likelihood of alteration of the bentonite that could degrade the desirable swelling properties.
- Predict the stresses generated by the expansion of the corrosion products and the increase of temperature.

CODE_BRIGHT is a code especially well suited to model the thermo-hydro-mechanical behaviour of the bentonite. The equations solved by the code result from substitution of constitutive equations and equilibrium restrictions into balance equations of mass, linear momentum and energy. The result is a system of partial differential equations in the following variables: solid displacements, liquid pressure, gas pressure and temperature. Darcy's and Fick's laws replace the balance of momentum for phases and components in phases, respectively. These laws are considered in the set of constitutive equations, which also include, among others, the mechanical model, the retention curve and Fourier's law. The assumption of phase change equilibrium of water or air in gas phase and liquid phase leads to the psychometric law and the Henry's law, respectively.

The dimension of the 2-D finite element mesh of ENRESA's T-H-M model is 17.5 x 1 000 m². The input data for the bentonite were obtained from the experiments of the FEBEX project and the constitutive models have been validated for this project. The initial saturation degree of the bentonite is 0.66. The value of the initial suction is 44.41 MPa. The temperature at 500 m is 30.5°C and the geothermal gradient is 0.035°C/m. The granite is considered isotropic and homogeneous material.

The Figure 2 represents the temperature evolution of some selected points in the bentonite: near the heat source, in the middle and near the outer part of the bentonite. The maximum temperature obtained was 95.2°C, 26.3 years after the disposal of the canister. At this time, the outer part of the bentonite has 75.8°C. During the first years the thermal gradient is high due to the high thermal power of the spent fuel. After 1 000 years, the thermal gradient across the buffer becomes uniform. The time needed to recover the original temperature is higher than 40 000 years.

Figure 2. Temperature evolution in the bentonite

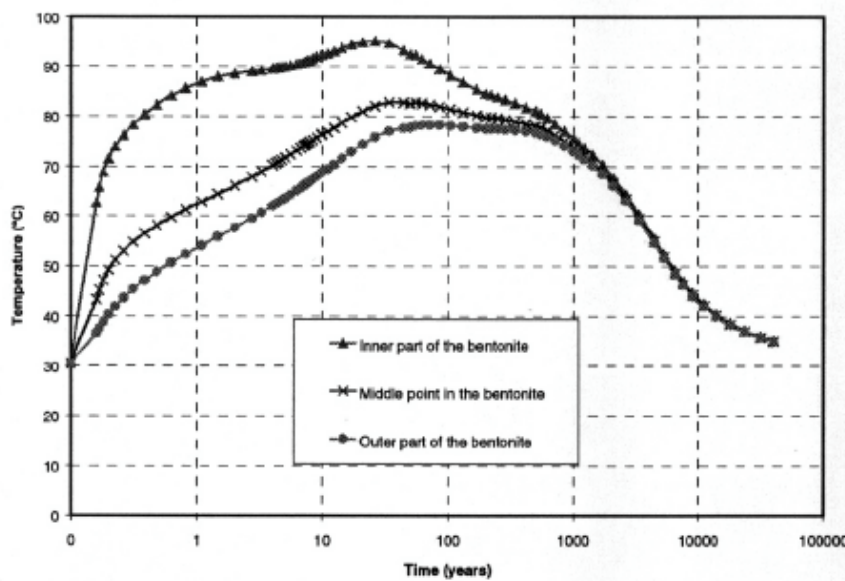

The evolution of the saturation degree is shown in the Figure 3. The time needed to saturate the bentonite is 7.4 years. This result is very sensitive to the retention curve of this material. At the beginning the inner part of the bentonite becomes dry due to the high temperatures. This drying process is less important in the outer part of the bentonite due to the lower temperatures. The total maximum stress is 11 MPa, being the sum of the swelling pressure of the bentonite and the hydrostatic pressure. The thermal expansion of the rock generates stresses. Due to the dimensions of the model and since the system is confined between the laterals the only way to release stresses is towards the ground surface.

Figure 3. Evolution of the saturation degree in the bentonite

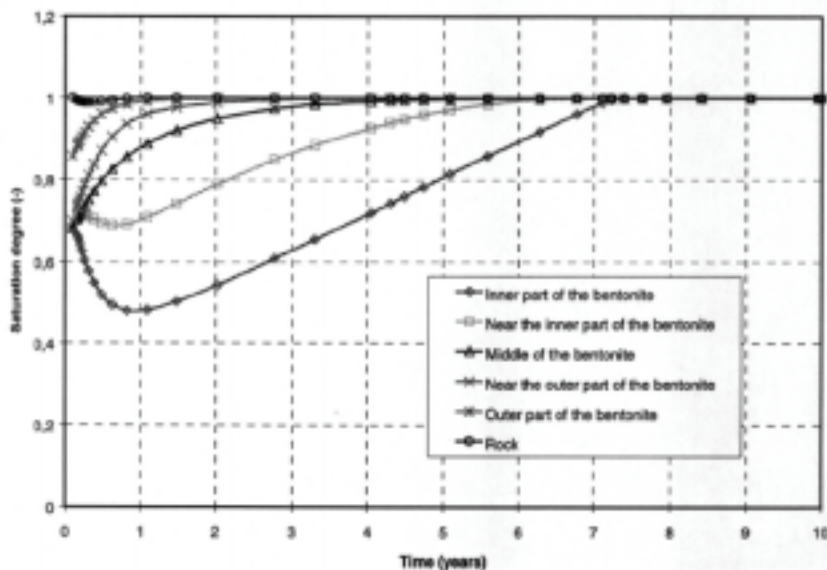

Conclusions extracted from the T-H-M calculations carried out are:

- The temperature in the buffer remains below the 100°C constraint.
- The resaturation process of the bentonite is quick and it homogenises the buffer material due to the swelling process.
- The buffer absorbs the stresses generated by the thermal expansion of the repository materials by means of its favourable plasticity characteristics.

3.2 *ENRESA's Geochemical modelling*

The groundwater saturates the bentonite barrier and dissolves some accessory minerals. As result of this interaction the porewater evolves. The chemistry of the porewater (concentration of dissolved species, Eh, pH) as well as the chemical gradients may influence the chemical and physical properties of the bentonite materials, the corrosion rate of the canister, and the transport properties of the radionuclides. ENRESA's near field geochemical model for BENIPA predicts the evolution of the porewater composition, considering advection, diffusion, mineral dissolution and precipitation, aqueous complexation, cation exchange and surface adsorption. The bentonite porewater and the boundary groundwater tend to reach the equilibrium by diffusion. The calculation of the geochemical evolution provides at different time steps the concentration of the majority of species in the bentonite, the evolution of pH and Eh, the precipitation and dissolution of accessory mineral phases and the final composition of the exchange complex.

The computer code used for the calculations is CORE^{2D}, which solves solute transport coupled with chemical equilibrium and kinetics of reactions taking place in the aqueous phase such as acid-base, redox and aqueous complexation or in the solid phase such as surface adsorption, ion exchange, mineral dissolution and precipitation. Thermal coupling is taken into account for thermodynamical constant reaction adjustment. CORE^{2D} is based on the sequential iteration approach to solve the coupled hydrological transport processes and hydrogeochemical reactions, which are solved separately in a sequential manner following an iterative procedure. The finite element method is used for spatial discretization, while implicit, explicit and general finite difference schemes are used for time discretization.

A simplified 2D-axisymmetric model (a cylindrical slice) is considered. Bentonite, EDZ and several meters of rock, in order to take into account properly the boundary conditions, have been modelled as homogeneous and isotropic porous media. Values for hydraulic conductivity, diffusion coefficient, dry density, porosity, thermal conductivity and heat capacity are assigned to each component of the model. Every material can be split in several zones each one with particular porewater, mineral composition, ion exchange capacity and adsorption properties. The mineral composition of the bentonite and the porewater chemical composition of bentonite and groundwater define the initial conditions. The hydraulic flow at the bentonite/granite interface and the temperature evolution define the boundary conditions.

An initial calculation is needed in order to obtain the porewater composition of the saturated bentonite. This calculation takes into account the mixing of the non-saturated bentonite porewater with the granite groundwater and the interactions with the solid phase; mainly the dissolution of the accessory minerals and the cation exchange. The chemical evolution of the porewater during the saturation process is then calculated. The results in the middle point of bentonite 100 years are used as input for the geochemical model in saturated conditions. The time frame for the calculation is one

million years. In this period, the geochemical environment evolves to alkaline and reducing conditions as it is shown in Figure 4. There is a thermal effect on the pH and pe behaviour. At the beginning of the calculation the temperature is over 85°C. At this moment the neutral pH is around 6.25. Redox evolution is close related to Fe+2 behaviour.

Figure 4. Evolution of the pH and pe in the bentonite

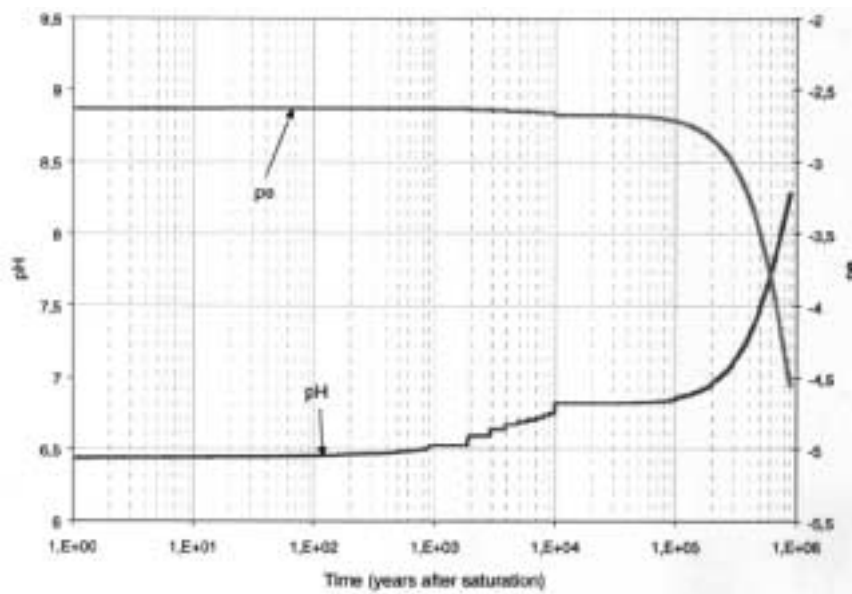

The concentration of the aqueous geochemical components, shown in Figure 5 evolves from the initial bentonite porewater values to the granite groundwater values. The velocity of this evolution depends on the diffusion coefficients and the groundwater flow in the granite. In the time period considered the porewater concentration does not reach the groundwater level.

Figure 5. Concentration of chemical components in the bentonite porewater

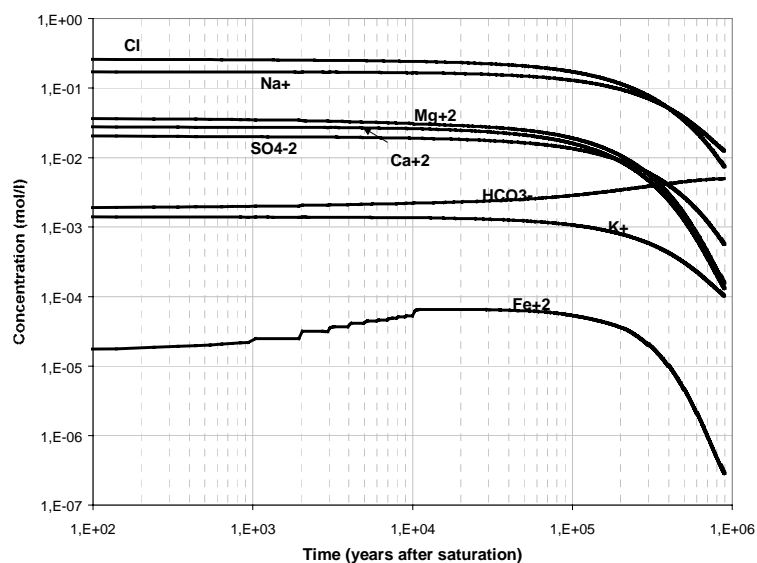

Except for carbonates, the concentrations of the main species are higher in the bentonite porewater than in the original groundwater. This situation originates the migration of the species from bentonite to granite. Precipitation and dissolution of calcite is important close to the bentonite/granite interface. Finally, by the end of the simulation the calcite precipitated begins to dissolve raising the pH. Conclusions extracted from the geochemical calculations carried out are:

- The bentonite is a very good chemical buffer for high pH due to its contents in alkaline regulators, (calcite and anhydrite) and the contribution of the cation exchange. The presence of magnetite as the corrosion products of the canister controls the ionic pair $\text{Fe}^{+3}/\text{Fe}^{+2}$, guarantying the redox regulation.
- It is not expected to have strong variations in the geochemical environment for a million years, therefore, radionuclide solubilities for transport calculations are to be provided for a definite range of conditions.
- The up scaling of the results to the whole repository needs to take into consideration the spatial variability of the parameters, mainly the in-situ temperature and the chemical compositions. A range of variability of these parameters has to be considered to link the results to the overall performance.

3.3 *ENRESA's integrated transport model*

After canister failure, the groundwater reaches the waste and radionuclide release starts. Three different contributions are considered: a) the inventory in the pellet-cladding gap and UO_2 grain boundaries, released instantaneously after canister failure, b) the activation products in the cladding and structural components, released in 1000 years at a constant rate and c) the inventory in UO_2 matrix, that contains most of the radionuclides in a fuel element. The inventory in the UO_2 matrix is released slowly, congruently with the matrix oxidation due to alpha analysis.

The geochemical evolution of bentonite porewater provides the solubility limits for the different chemical species. Radionuclides released from the waste dissolve or precipitate in the free water around the waste, depending on their solubility limits. Radionuclide concentration in the water around the waste is the boundary condition at the inner surface of the bentonite for transport through the bentonite barrier. Due its low hydraulic conductivity, transport through the bentonite is controlled by diffusion. At the outer surface of the bentonite the radionuclides diffuse into the granite in the Excavation Damaged Zone (EDZ) and the intact granite beyond the EDZ. Since water flows through the granite parallel to the galley axis, both advection and diffusion are considered in the granite.

The computer code used for the transport calculations is GoldSim, which includes an algorithm of mixing cells to simulate radionuclide transport in porous media. The physical system is discretised into several mixing cells that are linked together using advective and diffusive connections. Within a cell, all species mass is assumed to be instantaneously and completely mixed and equilibrated among all of the media in the cell: liquids and solids. When multiple cells are linked together, the behaviour of the cell network is mathematically identical to a network of finite difference nodes describing a coupled system of differential equations.

The mixing cells allow modelling all the relevant transport processes: precipitation/dissolution, isotopic dilution, anion exclusion, sorption on porous media and radioactive decay/ingrowth. Figure 6 shows the near field model. The magnitude used to quantify the performance of the bentonite, as a transport barrier, is the activity flux released released from the near field for each radionuclide.

Figure 6. **Compartment model used in transport calculations**

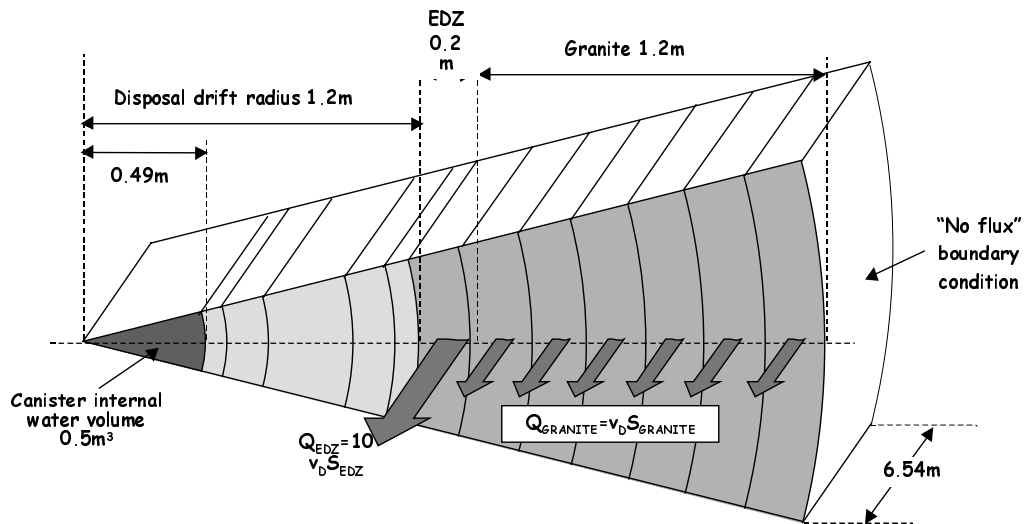

In order to gain confidence in the models developed, preliminary transport calculations were performed for 3 stable species with different transport parameters (cation, anion and neutral species) for both solubility limited inputs and delta pulse inputs (six different calculations). Results were compared with those obtained by VTT, for the same reference case being the agreement very good.

After preliminary calculations complete calculations were carried out. Radionuclide release rates from the near field are shown in Figure 7. Only radionuclides with peak release rate greater than 1Bq/y are shown in the figure. Releases from the near field of weakly sorbed or non-sorbed species start early after canister failure, while sorbed species are significantly delayed.

Figure 7. **Release rates from the near field (Bq/yr-canister)**

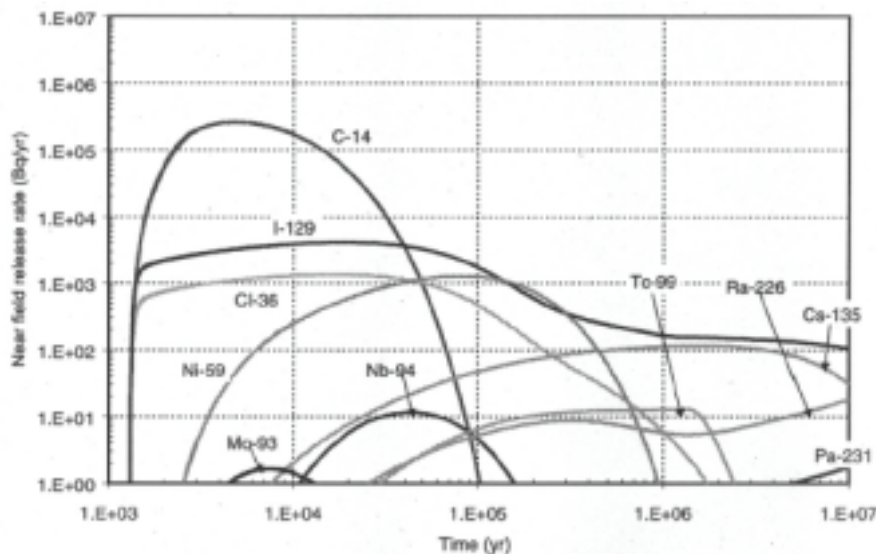

Transport calculations show that radionuclide release rates from the near field are quite small. To put these releases into perspective, a dose calculation was carried out assuming that the radionuclides released from the near field of the entire repository are discharged directly to the biosphere (transport in geosphere is ignored). This means that the releases are assumed to be dissolved in a river of $1\text{E}6\text{ m}^3/\text{yr}$ flow rate. Doses are calculated multiplying the activity concentrations by the radionuclide-specific Biosphere Dose Conversion Factors calculated for a Spanish biosphere. Total peak dose is about $2\text{E}-5\text{ Sv/yr}$, well below the Spanish reference value of $1\text{E}-4\text{ Sv/yr}$. Conclusions extracted from the integrated transport calculations carried out are:

- The bentonite is a very efficient barrier in delaying and limiting the releases of radionuclides. If low groundwater flows are expected in the near field, the bentonite barrier by itself can ensure acceptable releases and doses to the biosphere.
- Releases from the near field are controlled by high-solubility radionuclides, such as C-14, I-129, Cl-36, Ni-59 and Cs-135. Low solubility represents a very useful chemical characteristic for limiting radionuclide transport.
- The very similar results obtained by VTT and ENRESA in the calculations of the same reference case increased the confidence in the codes (REPCOM and GoldSim) used by both organisations in their PA exercises.

References

- [1] Bentonite Barriers in Integrated Performance Assessment. BENIPA. Description of Work. Waste Management and Disposal Project FIS5-1999-00116. Document Revision No. 1/13.04.2000.
- [2] BENIPA Project. Overview of Disposal Concepts for Clay and Granite. Deliverable D1. Rev. 0. March 2001.
- [3] BENIPA Project. Reference Cases for Analysis. Deliverable D2. Rev. 0. May 2001.
- [4] BENIPA Project. Treatment of Bentonite Barriers Related FEP's in Integrated Performance Assessment. Deliverable D3. Rev. 0. January 2002.
- [5] BENIPA Project. Project Handbook of Relevant Data for Safety Assessment of Bentonite Barriers. Deliverable D4. Rev. 0. February 2002.
- [6] BENIPA. Analysis of Models Applicable to the Assessment of Bentonite Barriers. Deliverable D5. Rev. 0. December 2002.
- [7] BENIPA Project. Data Generation Process. Deliverable D6. Rev. 0. April 2002.

APPENDIX C

REMIT AND COMPOSITION OF WORKING GROUPS

WORKING GROUPS REMIT

The workshop will concentrate on identification of issues related to the EBS and on its integration into the overall safety case, and discuss approaches to resolve these issues. In particular, the workshop should come to a final conclusion on the desirability and feasibility of an international project in this area. This project should follow the same format as for GEOTRAP with a series of workshops that will be a useful platform for exchanges between radioactive waste organisations and the scientific community on the EBS.

The major opportunity to provide input into the workshop conclusions and, therefore, proceedings will be during the Working Group sessions. In order to design the outlines of the subsequent Workshops, the main tasks of the Working Groups are:

- To compile relevant issues from the point of view of addressing them in a practical manner within an international co-operative project;
- To confirm early suggestions or provide new suggestions on the contents of the subsequent workshops.

The Working Groups will aim to set definite topics and priorities in order to plan a focused and efficient project. The Programme Committee feels that suitable topics should be judged based on:

- Relevance and applicability within the current safety cases/assessments: it should be clear that the series of workshops will not work on issues simply for their interest from a research point of view but will be a platform for integration of sciences into safety. Therefore, the experience of many of the participants in the preparation of current safety cases should be brought to bear in this context.
- Exchange of strategies, approaches and relevant experience. The series of workshops will share knowledge and experience about the integration of the four perspectives regarding the EBS, namely engineering design, characterisation, process modelling, and performance assessment, in order to understand and document the state-of-the-art and identify the key common issues or uncertainties that need to be resolved. However, if significant progress is judged unlikely to be made within a three- to five-year time frame, it might be best to give these issues a lower priority compared to other issues that are demonstrably of greater importance and urgency to establishing the technical basis of repository safety cases.

During the working group discussions, participants should answer the following questions:

- What are the arguments for or against international co-operation on these potential issues?
- To what extent are participants prepared to discuss in detail the approaches made in their national programme?
- Are the proposed issues relevant and of significant impact for an international workshop? What issues need to be modified, clarified, created?

Suggestions for the subsequent Workshops

The Working Groups are also asked to discuss the potential modes of operation, in particular:

- The appropriateness of the number of proposed workshops. If a Working Group feels some of the proposed workshops might be combined, or if a topic proposed into the previous version of this programme is more relevant, the Working Group should explain their reasoning and propose the new content of the combined workshops.
- The relevant perspective, expertise and experience of participants.
- Progress to be anticipated through the series of workshops.

Working Group A

DESIGN-CRITERIA AND CONSTRUCTION

Chairperson: Paul Gierszewski
Rapporteur: Frédéric Plas

Introductory presentation by Alan Hooper, United Kingdom Nirex limited “The selection and Specification of Engineered Barriers for the Nirex Phased Disposal Concept”.

Within the multi-barrier system, the EBS itself comprises a variety of components, such as the waste form itself, waste canisters, backfill, seals, and plugs. The general purpose of an EBS is to prevent and/or delay the release of radionuclides from the waste to the repository host rock, at least during the first several hundreds of years after repository closure when fission-product content is high, where they might be mobilised by natural groundwater flow. In many disposal concepts, the EBS, operating under stable and favourable geosphere conditions, is designed to contain most of the radionuclides for much longer periods.

The specific role that an EBS is designed to play in a particular waste disposal concept is dependent on the conditions that are expected (or considered possible) to occur (“scenarios”) over the period of regulatory interest, regulatory requirements for waste containment, and the anticipated performance of the natural geologic barrier. To be effective, an EBS must be tailored to the specific environment in which it is to function. Ensuring that an EBS will perform its desired functions requires an integration, often iterative, of site-characterisation data, data on waste properties, data on engineering properties of potential barrier materials, in situ and laboratory testing, and modelling.

In addition, the development of a concept implies the concrete definition of the different components of the system to be constructed to accommodate the waste packages, taking account of the different types of package and the volumes concerned, to preserve the possibility of retrieving these packages and to contain the radionuclides over long periods of time.

SCOPE

- Role played by the EBS at different time scales, in the overall PA and safety case.
- Components of the EBS.
- EBS-design options to mitigate adverse effects (e.g. criticality, emplacement, etc.).
- Baseline assumptions underlying the design.
- Implication of retrievability on design.
- Implication of step-wise decision-making process to the design evolution and/or optimisation.
- Implication of regulations on the design.
- Key lessons from peer reviews (internal /external).
- Main EBS experiments in the URL.

- Key uncertainties/outstanding issues regarding the design and emplacement of the EBS
- Estimation of “initial” conditions for post-closure modelling.
- Options for testing and characterisation of properties and conditions (expected/ altered).
- Implications/opportunities for monitoring and testing.

Working Group B

THERMO-HYDRO-MECHANICAL (THM) PROCESSES

Chairperson: Mick Apted
Rapporteur: Robert MacKinonn

The excavation, the construction of the EBS and the operation of the repository cause important changes in the stress regime and the hydraulic conditions of the geological media; the progressive closure and sealing of the repository are important steps in the evolution of the hydromechanical evolution of the system, where the EBS and the host formations mutually interact. Furthermore, heat generating wastes modify the temperature of the system, and thereby the thermo-hydro-mechanical evolution through different coupled processes. In the medium and long term, changes in the environmental conditions and alterations in the properties of the EBS materials may also originate changes that may be of relevance for the performance of the system.

Design and ultimate performance of an EBS are not dependent solely on the undisturbed conditions and properties of the repository host rock, but also on how those conditions and properties may change as a result of repository construction and operation and waste emplacement. These “repository-induced influences” evolve with time in a complicated interaction with the EBS.

The manner in which the properties and THM conditions in the host rock are affected by a repository is dependent on such factors as the rock excavation methods used, the duration of operations prior to closure, the heterogeneities and discontinuities in the host rock, the engineering measures taken to maintain excavation stability and reduce water inflows, the chemical and mechanical properties of the materials used for backfilling and sealing, and the thermal load to which the rock is subjected.

SCOPE

- Significance of rock properties and EDZ on THM processes.
- Definition of causes (near-field FEP's) of repository-induced influences on EBS.
- Effects of repository-induced influences on EBS.
- Temporal evolution of conditions.
- Changing saturation with time.
- Interactions/coupling among processes and mechanisms.
- Effects of THM processes on radionuclide transport
- Interactions (definition and effects) among sealing materials, backfill, waste canisters, other repository contents, and near-field host rock (internal FEP's).
- External FEP's considered (e.g. tectonic movements).
- Implication of temporal evolution of barrier properties.
- Need for modelling of coupled THM processes over the different time scales.

- THM effect of waste packages.
- Treatment of uncertainty and variability; key issues.
- Gas migration, gas effects on EBS.
- Key issues related to boundary conditions in models.
- Characterisation of parameters: surface laboratory, URL, natural analogues.
- HM effects of corrosion products.
- Geometric complexity related to different locations within the repository.
- Non-conformance of emplaced EBS, validation of averaging (deviation from the initial conditions).

Working Group C

GEOCHEMICAL PROCESSES

Chairperson: Medhi Askarieh

Rapporteur: Patrik Sellin

There is a large diversity of geochemical FEP's that are relevant for the performance of a geological repository. The main transport mechanisms for radionuclides are advection-dispersion-diffusion of dissolved species in groundwater. Many radioactive species have limited solubility, depending on the geochemical environment. Furthermore, migration may be significantly retarded by solid-solute interactions; on the other hand several FEP's may enhance migration, as transport in colloidal form and formation of complexes. The mobilisation of the radionuclides is controlled at the start by the performance of the waste form, whose degradation is influenced by the environmental conditions in the near field. Chemical processes are also relevant to the EBS integrity and near-field performance by causing the changes in the EBS materials and the near-field host rock.

In many performance assessments, evolution of chemical and physical conditions of the EBS and near-field rock are analysed for a single waste package whose characteristics are derived by taking an ensemble average among many thousands of packages in a repository. In these analyses, effects of fluctuations in the EBS fabrication/emplacement conditions and spatial heterogeneity in the surrounding rock mass are "smeared out". In reality, the initial conditions at every waste package location will deviate to a certain extent from such an idealised representation.

Differences in spatial emplacement of waste packages within rooms (e.g., centre location, edge location, or corner location) and spatial positions of rooms within repositories, combined with natural geologic heterogeneity in the near-field host rock, will cause different evolutions of package degradation, leading to perhaps different times of contact by water, different times of container/overpack failure, or different rates of release of radionuclides from the waste form once containment is lost.

In addition, one can imagine a number of situations where material incompatibility between backfill, plugs, and tunnel supports, which are designed mainly focussing on their own functions, might compromise performance of the safety barriers. For example:

Chemical reactions of cementitious materials with groundwater raise pH of near-field pore water. Elevated solubilities and reaction rates of many alumino-silicate phases (including borosilicate glass and buffer minerals) under such a condition might result in enhanced dissolution of these phases and precipitation of secondary minerals such as CSH gel and zeolites. These changes may alter the performance of such barriers selectively along the paths where the hyper-alkaline plume and radionuclides migrate.

Chemical degradation of tunnel supports, together with reduced swelling capability of buffer material due to action exchange with concrete leachate, can lead to formation of additional flow paths along tunnels.

SCOPE

- Definition of causes (near-field FEP's) of repository-induced influences on EBS.
- Effects of repository-induced influences on EBS ; Interactions/coupling among processes and mechanisms.
- Modelling approaches, coupling, implications for far-field source term; temporal evolution of conditions.
- Conceptual model and parameter uncertainty.
- Relevant aspects related to corrosion products.
- Identification and relevance of stray materials.
- Key issues related to the solubility limits; determination and handling of uncertainties.
- Effects on radionuclide transport.
- Implications of heterogeneity in optimising design and repository layout.
- Non-conformance of emplaced EBS, validation of averaging.
- Methods of characterising variability in processes and properties.
- Scaling from the laboratory scale to the waste-canister scale to the repository scale.
- Modelling of interface between EBS and near-field host rock.
- Approaches to optimisation of performance (e.g. variable spacing, location-dependent backfill, etc.).
- Potential for monitoring to resolve or constrain key issues.
- Compatibility of seal and backfill materials with other components.
- Opportunities for design changes (e.g. chemically tailored backfills) to mitigate adverse effects.

Working Group D

RADIONUCLIDE RELEASE AND MIGRATION

Chairperson: Bo Stromberg

Rapporteur: Jesus Alonso

Introductory presentation by F. Wong

“Overview of the Yucca Mountain Waste Package Materials and Waste form Degradation Activities”

The ultimate aim of an EBS is to minimise (or prevent) and delay the release of radionuclides to the geologic portion of the multi-barrier system. How and when this release occurs are important factors in the overall performance assessment of a repository. To arrive at an understanding of this release, flow, transport, and retention properties and processes within the EBS must be characterised and modelled. The modelling of these processes within the repository is then used to provide a radionuclide source term for far-field transport models used in performance assessment. Important aspects of this source term include: fluxes of radionuclides as a function of time, geochemical conditions of radionuclide-bearing fluid, spatial location and extent of radionuclide plume, and the hydraulic parameters controlling flow through the repository (chiefly permeability and pressure).

The modelling of radionuclide transport in the near field should pay due attention to the temporal changes in the environmental condition, and to the evolution of the properties of the intervening materials.

In addition, in some repository safety assessments, the expected performance of a single waste package is simulated and then multiplied by the number of packages to get a total source term. It is conceivable, however, that the performance of the different waste packages differ each other because intrinsic variability or heterogeneity in environmental conditions. Furthermore, the performance of one package might impact the performance of neighbouring waste packages. As the number of waste packages grows into the thousands, it may be prudent to verify that the modelling of a single waste package may be taken as representative of the whole population, or if, on the contrary, a more sophisticated approach is warranted.

SCOPE

- Integration of relevant FEPs.
- External FEPs considered (e.g. human intrusion).
- Waste form degradation (release of RN, processes).
- Timing and rate of release of radionuclides from EBS to flowing groundwater within repository.

- Modelling of flow through the repository, including geochemical evolution of fluid.
- Geometric complexity related to different locations within the repository.
- Characterisation and modelling of radionuclide migration and retention processes within the heterogeneous repository and near-field host rock.
- Modelling of interface between the near-field and far-field (definition of radionuclide source term to the far field), including geochemical gradients.
- Surface and URL experiments to provide relevant data.
- Impact of EDZ on RN migration.
- Non-conformance of emplaced EBS, validation of averaging (deviation from the initial conditions).
- Approaches to optimisation of performance (e.g. variable spacing, location-dependent backfill).
- Modelling of interface between EBS and near-field host rock.
- Treatment of uncertainty and variability.
- Contribution of the EBS to enhancing the robustness of the overall multiple barrier system.
- Is there a scope for the monitoring of radionuclides in the near field?

WORKING GROUPS COMPOSITION

Working Group A

Design Criteria and Construction

Chairperson:

Paul GIERSZEWSKI (Ontario Power Generation, Canada)

Rapporteur:

Frederic PLAS (Andra, France)

Participants:

Jean-Paul BOYAZIS (ONDRAF/NIRAS, Belgium); Timo ÄIKÄS (POSIVA, Finland); Nina MULLER-HOEPPE (DBE, Germany); Giuseppe SEDDA (APAT, Italy); Luigi NOVIELLO (SOGIN, Italy); Hiroyoshi UEDA (NUMO, Japan); Alan HOOPER (Nirex, United Kingdom); David BENNETT (GSL, United Kingdom); Frank HANSEN (SNL, USA); Sylvie VOINIS (OECD/NEA).

Working Group B

Thermo-Hydro-Mechanical Processes

Chairperson:

Micheal Apted (Monitor Scientific, USA)

Rapporteur:

Robert MacKinnon (SNL, USA)

Participants:

Thierry LASSABATÈRE (EDF, France); Ralf MAUKE (BFS, Germany); Roland PUSCH (GEODEVELOPMENT AB, Sweden); Johannes VIGFUSSON (HSK, Switzerland); Stephen HORSEMAN (BGS, United Kingdom); Dan BULLEN (NWTBR, USA).

Working Group C

Geochemical Processes

Chairperson:

Mehdi ASKARIEH (Nirex, United Kingdom)

Rapporteur:

Patrik SELLIN (SKB, Sweden)

Participants:

Bruno GÉRARD (IRSN, France); Masao SHIOTSUKI (JNC, Japan); Jae Owan LEE (KAERI, Korea); Li-Min CHI (INER, Taiwan); Carlos DIBELLA (NWTRB, USA).

Working Group D

Radionuclide Release and Migration

Chairperson:

Bo STROMBERG (SKI, Sweden)

Rapporteur:

Jesus ALONSO (ENRESA, Spain)

Participants:

Martina LIGAUNOVA (RAWRA, Czech Republic); Stefan MAYER (Andra, France); Emmanuel MOUCHE (CEA, France); Xavier Sillem (CENISEK, Belgium); Richard STORCK (GRS, Germany); Hiroyuki UMEKI (NUMO, Japan); Timo VIENO (POSIVA, Finland); Henning VON MARAVIC (European Commission); Frank WONG (USDOE, USA).

APPENDIX D

LIST OF PARTICIPANTS

BELGIUM

BOYAZIS Jean-Paul
ONDRAF-NIRAS
Place Madou 1 Box 25
B-1210 Bruxelles

Tel: + 32 2 212 10 52
Fax: + 32 2 218 51 65
E-mail: jp.boyazis@nirond.be

SILLEN, Xavier
Centre d'Étude de l'Énergie Nucléaire
(CEN•SCK)
Boeretang 200
B-2400 Mol

Tel: + 32 (0) 14 333 237
Fax: + 32 (0) 14 323 553
E-mail: xsillen@sckcen.be

CANADA

GIERSZEWSKI, Paul
Ontario Power Generation
Long-Term Waste Management
Technology Department
700 University Avenue H16 E27
Toronto M5G IX6

Tel: +1 416 592 2346
Fax: +1 416 592 7336
E-mail: paul.gierszewski@opg.com

CHINESE TAIPEI

CHI, Li-Min
Institute of Nuclear Energy Research
P.O Box 3-7, Lungtan 325
Taoyuan

Tel: +886 3 47 11 400 (Ext: 5613)
Fax: + 886 3 47 11 411
E-mail: lmchi@iner.gov.tw

CZECH REPUBLIC

LIGAUNOVA, Martina
Radioactive Waste Repository Authority
(RAWRA)
Dlazdena 6, 110 00, PRAHA 1

Tel: +420 2 214 215 40
Fax: +420 2 214 215 44
E-mail: ligaunova@rawra.cz

FINLAND

ÄIKÄS, Timo
Posiva Oy
27160 Olkiluoto
FIN-00100 Helsinki

Tel: +358(0) 2 8372 3730
Fax: +358(0) 2 8372 3719
E-mail: timo.aikas@posiva.fi

VIENO, Timo
VTT Processes
P.O. Box 1608
FIN-02044 VTT

Tel: +358 9 456 5066
Fax: +358 9 456 6390
E-mail: timo.vieno@vtt.fi

FRANCE

GERARD, Bruno
IRSN/DES/SESID
BP 17
F-92262 Fontenay-aux-Roses Cedex

Tel: +33 1 58 35 77 55
Fax: +33 1 58 35 77 27
E-mail: gerard.bruno@irsn.fr

MAYER, Stefan
Andra
1-7 rue Jean Monnet
F-92290 Chatenay-Malabry Cedex

Tel: + 33 1 46 11 80 72
Fax: + 33 1 46 11 83 38
E-mail: stefan.mayer@andra.fr

LASSABATÈRE, Thierry
EDF
R&D, Département MMC
Centre des Renardières, BÂT MTC1
F-77818 Moret-sur-Loing

Tel: +33 (0) 1 60 73 75 01
Fax: +33 (0) 1 60 73 65 59
E-mail: thierry.lassabatere@edf.fr

MOUCHE, Emmanuel
Commissariat à l'Énergie Atomique (CEA)
DM25/SFME/MTMS
Centre d'Études Nucléaires Saclay
F-91191 Gif-sur-Yvette Cedex

Tel: +33 1 69 08 22 54
Fax: +33 1 69 08 96 96
E-mail: emmanuel.mouche@cea.fr

PLAS, Frédéric
Andra
1-7 rue Jean Monnet
F-92290 Chatenay-Malabry Cedex

Tel: +33 01 46 11 81 78
Fax: +33 01 46 11 80 13
E-mail: frederic.plas@andra.fr

GERMANY

MAUKE, Ralf
Bundesamt für Strahlenschutz (BfS)
Federal Office for Radiation Protection
Department of Waste Management and Trans.
Safety Analysis, P.O. Box 10 01 49
Willy-Brandt-Strasse 5,
D-38201 Salzgitter,

Tel: +49 1888-333 1963
Fax: +49 1888-333 1605
E-mail: rmauke@bfs.de

MULLER-HOEPPE, Nina
Deutsche Gesellschaft zum
Bau u. Betrieb von Endlagern
für Abfallstoffe mbH (DBE)
Eschenstr, 55,
D-31224 Peine

Tel: + 49 5171 43 1529
Fax: +49 (5171) 43 1218
E-mail: mullerhoepf@dbe.de

STORCK, Richard
Gesellschaft fuer Anlagen und
Reaktorsicherheit (GRS) mbH
Theodor-Heuss-Strasse 4
D-38122 Braunschweig

Tel: +49 (0)531 8012 205
Fax: +49 (531) 8012 211
E-mail: sto@grs.de

ITALY

NOVIELLO, Luigi
 SOGIN
 Via Torino no. 6
 I-00184 Roma

Tel: +39 06 830 40248
 Fax: +39 06 830 40475
 E-mail: noviello@sogin.it

SEDDA, Giuseppe
 ANPA-ARE-AMM
 Via Vitaliano Brancati, 48
 I-00144 Roma

Tel: + 39 06 500 72916
 Fax: + 39 06 500 72 941
 E-mail: sedda@anpa.it

JAPAN

SHIOTSUKI, Masao
 Geological Isolation Research Project
 Japan Nuclear Cycle Development
 Institute (JNC)
 4-49, Muramatsu, Tokai-mura
 Ibaraki, 319-1184

Tel: +81 29 282 4237
 Fax: +81 29 282 8174
 E-mail: siotuki@hq.jnc.go.jp

UEDA, Hiroyoshi
 Science and Technology Department
 Nuclear Waste Management Organization
 of Japan (NUMO)
 Mita NN Bldg., 4-1-23 Shiba, Minato-Ku
 Tokyo 108-0014

Tel: +81 3 4513 1534
 Fax: +81 3 4513 1599
 E-mail: hueda@numo.or.jp

UMEKI, Hiroyuki
 Science and Technology Department
 Nuclear Waste Management Organization
 of Japan (NUMO)
 Mita NN Bldg., 4-1-23, Shiba, Minato-Ku,
 Tokyo 108-0014

Tel: +81 (0)3 4513 1503
 Fax: +81 (0)3 4513 1599
 E-mail: humeki@numo.or.jp

KOREA (REPUBLIC OF)

LEE, Jae Owan
 HLW Disposal Technology Development
 Korea Atomic Energy Research Institute
 P.O.Box 105, Yusong
 Taejon 305-600

Tel: +82 42 8682852
 Fax: +82 428688850
 E-mail: jolee@kaeri.re.kr

SPAIN

ALONSO, Jesus
 ENRESA
 Calle Emilio Vargas, 7
 E-28043 Madrid

Tel: +34 91 566 8108
 Fax: +34 91 566 8165
 E-mail: jald@enresa.es

VELA, Antonio
Consejo de Seguridad Nuclear (CSN)
Justo Dorado, 11
E-28040 Madrid

Tel: +34 91 346 0231
Fax: +34 91 346 0588
E-mail: avg@csn.es

SWEDEN

PUSCH, Roland
Swedish Geological Science Park Ideon
University Site
S-223 70 Lund

Tel: +46 16 85 80
Fax: +46 12 98 79
E-mail: pusch@geodevelopment.ideon.se

SELLIN, Patrik
SKB
Box 5864
S-102 40 Stockholm

Tel: +46 (8) 459 8522
Fax: +46 (8) 662 4974
E-mail: skbps@skb.se

STROMBERG, Bo
Office of Nuclear Waste
Swedish Nuclear Power Inspectorate (SKI)
S-10658 Stockholm

Tel: +46 8 698 84 06
Fax: +46 8 661 9086
E-mail: bo.stromberg@ski.se

SWITZERLAND

VIGFUSSON, Johannes O.
Section for Transport and Waste Management
HSK - Swiss Federal Nuclear Safety
Inspectorate
CH-5232 Villigen-HSK

Tel: +41(0)56 310 3974
Fax: +41 (0)56 310 3907
E-mail: johannes.vigfusson@hsk.psi.ch

UNITED KINGDOM

BENNETT, David G.
Galson Sciences Limited
5 Grosvenor House
UK-Melton Road, Oakham LE15 6AX

Tel: +44 1572 770649
Fax: +44 1572 770650
E-mail: dgb@galson-sciences.co.uk

ASKARIEH, Mehdi
United Kingdom Nirex Limited
Curie Avenue
Harwell, Didcot
UK-Oxfordshire OX11 0RH

Tel: +44 (1235) 825 403
Fax: +44 (1235) 820 560
E-mail: mehdi.askarieh@nirex.co.uk

HOOPER, Alan J.
United Kingdom Nirex Limited
Curie Avenue
Harwell, Didcot
UK-Oxfordshire OX11 0RH

Tel: +44 (0) 1235 825 401
Fax: +44 (0) 1235 825 560
E-mail: alan.hooper@nirex.co.uk

HORSEMAN, Stephen T.
British Geological Survey
Kingsley Dunham Centre
UK-Keyworth, Nottingham NG12 5GG

Tel: +44 115 936 3531
Fax: +44 115 936 3261
E-mail: stho@bgs.ac.uk

UNITED STATES OF AMERICA

APTED, Michael J.
Monitor Scientific
3900 S. Wadsworth #555
Denver, CO 80235

Tel: +1 (303) 985 00 05 (ext.:105)
Fax: +1 (303) 980 59 00
E-mail: maped@monitorsci.com

BULLEN, Dan
Nuclear Waste Technical Review Board
2300 Clarendon blvd Suite 1300
Arlington, VA 22209

Tel: +1 703 235 4473
Fax: +1 703 235 4494
E-mail: dbullen@iastate.edu

DIBELLA, Carlos
Nuclear Waste Technical Review Board
2300 Clarendon Blvd. Suite 1300
Arlington, VA 22209

Tel: +1 703 235 4473
Fax: +1 703 235 44 94
E-mail: dibella@nwtrb.gov

HANSEN, Frank
Sandia National Laboratories (SNL)
4100 National Parks Highway
Carlsbad, NM, USA 88220

Tel: +1-505-234-0066
Fax: +1-505-234-0051
E-mail: fdhanse@sandia.gov

MACKINNON, Robert
Sandia National Laboratories (SNL)
MS 0778
P.O. Box 5800
Albuquerque, NM 87185-0778

Tel: +1 (505) 844 1069
Fax: +1 (505) 284 4002
E-mail: rjmacki@sandia.gov

WONG, Frank M.G.
Lawrence Livermore National Laboratory
7000 East Avenue, L-631
Livermore, CA 94550

Tel: +1 702 794 5078
Fax: +1 702 794 1323
E-mail: frank_wong@notes.ymp.gov

INTERNATIONAL ORGANISATIONS

VON MARAVIC, Henning
European Commission
DG RTD J4
MO75, 5/50
B-1049 Bruxelles

Tel: +32(0) 2 29 65273
Fax: +32 (0) 2 29 54991
E-mail: henning.ritter-von-maravic@cec.eu.int

VOINIS, Sylvie
OECD/NEA
RPWM
12, Boulevard des Iles
F-92130 Issy-les-Moulineaux

Tel: +33 1 45241049
Fax: +33 1 45241145
E-mail: sylvie.voinis@oecd.org