



Off-Site Nuclear Emergency Exercises

Exercices d'application hors site des plans d'urgence en cas d'accident nucléaire

Proceedings of an NEA Workshop
Compte rendu d'une réunion de travail de l'AEN

The Hague, Netherlands, 12 - 15 November 1991



ORGANISATION FOR ECONOMIC CO-OPERATION AND DEVELOPMENT

Pursuant to Article 1 of the Convention signed in Paris on 14th December 1960, and which came into force on 30th September 1961, the Organisation for Economic Co-operation and Development (OECD) shall promote policies designed:

- to achieve the highest sustainable economic growth and employment and a rising standard of living in Member countries, while maintaining financial stability, and thus to contribute to the development of the world economy;
- to contribute to sound economic expansion in Member as well as non-member countries in the process of economic development; and
- to contribute to the expansion of world trade on a multilateral, non-discriminatory basis in accordance with international obligations.

The original Member countries of the OECD are Austria, Belgium, Canada, Denmark, France, Germany, Greece, Iceland, Ireland, Italy, Luxembourg, the Netherlands, Norway, Portugal, Spain, Sweden, Switzerland, Turkey, the United Kingdom and the United States. The following countries became Members subsequently through accession at the dates indicated hereafter: Japan (28th April 1964), Finland (28th January 1969), Australia (7th June 1971) and New Zealand (29th May 1973). The Commission of the European Communities takes part in the work of the OECD (Article 13 of the OECD Convention).

NUCLEAR ENERGY AGENCY

The OECD Nuclear Energy Agency (NEA) was established on 1st February 1958 under the name of the OEEC European Nuclear Energy Agency. It received its present designation on 20th April 1972, when Japan became its first non-European full Member. NEA membership today consists of all European Member countries of OECD as well as Australia, Canada, Japan and the United States. The Commission of the European Communities takes part in the work of the Agency.

The primary objective of NEA is to promote co-operation among the governments of its participating countries in furthering the development of nuclear power as a safe, environmentally acceptable and economic energy source.

This is achieved by:

- encouraging harmonization of national regulatory policies and practices, with particular reference to the safety of nuclear installations, protection of man against ionising radiation and preservation of the environment, radioactive waste management, and nuclear third party liability and insurance;
- assessing the contribution of nuclear power to the overall energy supply by keeping under review the technical and economic aspects of nuclear power growth and forecasting demand and supply for the different phases of the nuclear fuel cycle;
- developing exchanges of scientific and technical information particularly through participation in common services;
- setting up international research and development programmes and joint undertakings.

In these and related tasks, NEA works in close collaboration with the International Atomic Energy Agency in Vienna, with which it has concluded a Co-operation Agreement, as well as with other international organisations in the nuclear field.

© OECD 1993

Applications for permission to reproduce or translate all or part of this publication should be made to:

Head of Publications Service, OECD
2, rue André-Pascal, 75775 PARIS CEDEX 16, France

ORGANISATION DE COOPÉRATION ET DE DÉVELOPPEMENT ÉCONOMIQUES

En vertu de l'article 1er de la Convention signée le 14 décembre 1960, à Paris, et entrée en vigueur le 30 septembre 1961, l'Organisation de Coopération et de Développement Économiques (OCDE) a pour objectif de promouvoir des politiques visant :

- à réaliser la plus forte expansion de l'économie et de l'emploi et une progression du niveau de vie dans les pays Membres, tout en maintenant la stabilité financière, et à contribuer ainsi au développement de l'économie mondiale ;
- à contribuer à une saine expansion économique dans les pays Membres, ainsi que les pays non membres, en voie de développement économique ;
- à contribuer à l'expansion du commerce mondial sur une base multilatérale et non discriminatoire conformément aux obligations internationales.

Les pays Membres originaires de l'OCDE sont : l'Allemagne, l'Autriche, la Belgique, le Canada, le Danemark, l'Espagne, les États-Unis, la France, la Grèce, l'Irlande, l'Islande, l'Italie, le Luxembourg, la Norvège, les Pays-Bas, le Portugal, le Royaume-Uni, la Suède, la Suisse et la Turquie. Les pays suivants sont ultérieurement devenus Membres par adhésion aux dates indiquées ci-après : le Japon (28 avril 1964), la Finlande (28 janvier 1969), l'Australie (7 juin 1971) et la Nouvelle-Zélande (29 mai 1973). La Commission des Communautés européennes participe aux travaux de l'OCDE (article 13 de la Convention de l'OCDE).

L'AGENCE DE L'OCDE POUR L'ÉNERGIE NUCLÉAIRE

L'Agence de l'OCDE pour l'Énergie Nucléaire (AEN) a été créée le 1er février 1958 sous le nom d'Agence Européenne pour l'Énergie Nucléaire de l'OECE. Elle a pris sa dénomination actuelle le 20 avril 1972, lorsque le Japon est devenu son premier pays Membre de plein exercice non européen. L'Agence groupe aujourd'hui tous les pays Membres européens de l'OCDE, ainsi que l'Australie, le Canada, les États-Unis et le Japon. La Commission des Communautés européennes participe à ses travaux.

L'AEN a pour principal objectif de promouvoir la coopération entre les gouvernements de ses pays participants pour le développement de l'énergie nucléaire en tant que source d'énergie sûre, acceptable du point de vue de l'environnement, et économique.

Pour atteindre cet objectif, l'AEN :

- encourage l'harmonisation des politiques et pratiques réglementaires notamment en ce qui concerne la sûreté des installations nucléaires, la protection de l'homme contre les rayonnements ionisants et la préservation de l'environnement, la gestion des déchets radioactifs, ainsi que la responsabilité civile et l'assurance en matière nucléaire ;
- évalue la contribution de l'électronucléaire aux approvisionnements en énergie, en examinant régulièrement les aspects économiques et techniques de la croissance de l'énergie nucléaire et en établissant des prévisions concernant l'offre et la demande de services pour les différentes phases du cycle du combustible nucléaire ;
- développe les échanges d'information scientifiques et techniques notamment par l'intermédiaire de services communs ;
- met sur pied des programmes internationaux de recherche et développement, et des entreprises communes.

Pour ces activités, ainsi que pour d'autres travaux connexes, l'AEN collabore étroitement avec l'Agence Internationale de l'Énergie Atomique de Vienne, avec laquelle elle a conclu un Accord de coopération, ainsi qu'avec d'autres organisations internationales opérant dans le domaine nucléaire.

© OCDE 1993

Les demandes de reproduction ou de traduction totales ou partielles de cette publication doivent être adressées à :

M. le Chef du Service des Publications, OCDE
2, rue André-Pascal, 75775 PARIS CEDEX 16, France.

FOREWORD

The NEA Committee on Radiation Protection and Public Health took the initiative in 1990 to promote international co-operation in the field of off-site emergency exercises. The programme adopted, which took into consideration the experience gained from the Chernobyl accident, consists of two parts. The first part concerns information exchange on practices and lessons learnt from the conduct of emergency exercises at the local or national level, and the second will be devoted to the arrangement of NEA-sponsored international exercises. To finalise the information exchange part of the programme, a workshop on "Off-site Emergency Exercises" was organised. These proceedings contain the papers presented and a summary of the conclusions and recommendations that emerged from the discussions. The opinions expressed are those of the authors and do not commit the national authorities concerned.

Acknowledgement

The OECD Nuclear Energy Agency expresses its gratitude to the Dutch authorities who provided the excellent arrangements for the Workshop.

AVANT-PROPOS

Le Comité de Protection Radiologique et de Santé Publique a décidé de promouvoir la coopération internationale dans le domaine des exercices d'urgence à l'extérieur des sites nucléaires. Le programme adopté, qui a pris en conséquence l'expérience acquise à la suite de l'accident de Tchernobyl, se compose de deux parties. La première partie concerne un échange d'informations sur les pratiques et les leçons tirées de la réalisation d'exercices d'urgence au niveau local ou national et la seconde sera consacrée à la mise sur pied d'exercices internationaux patronnés par l'AEN. Une réunion de travail a été organisée sur "les exercices d'urgence hors site" afin de terminer les exposés présentés ainsi qu'un résumé des conclusions et des recommandations qui ont résulté des discussions. Les opinions exprimées sont celles des auteurs et n'engagent pas les autorités nationales concernées.

Remerciements

L'Agence de l'OCDE pour l'Énergie Nucléaire exprime ses remerciements aux autorités hollandaises responsables de l'excellente organisation de la réunion de travail.

Table of Contents - Table des matières

Introductory Note	11
Note d'introduction	14
C. Viktorsson (NEA)	

Session I

Overview of National Practices and Regional/International Programmes in the Area of Off-site Nuclear Emergency Exercises

Chairman: J.O. SNIHS (Sweden)

Survey on national practices and lessons learnt from off-site nuclear emergency exercises C. Viktorsson (NEA)	19
The IAEA emergency response system B. Weiss (IAEA)	29
Experience to date with the European Community urgent radiological information exchange (ECURIE) system G. Fraser (CEC)	40
Plans for internordic emergency exercises E. Stranden (Norway) and T. Bennerstedt (Sweden)	50

Session II

Technical and Organisational Aspects of the Conduct of Emergency Exercises

Chairman: B. WEISS (IAEA)

Nuclear emergency exercises in Canada F.B. Ali (Canada)	57
UK experience in the planning and the conduct of emergency exercises R.D. Mehew and A.J. Lindley (United Kingdom)	68
Emergency exercise "Mosel 90" H. Miska (Germany)	80
Exercise sievert M. Wallin and Å. Persson (Sweden)	86
National staff exercise in the Netherlands L.J.W.M. Bergman and A.H. Dal (the Netherlands)	96

Session III

Planning, Conduct and Principal Features, Benefits and Limitations of Various Types of Exercises: Table-top, Command-post and Field Exercises

Chairman: J. BOND (Canada)

United States experience with the planning, conduct and lessons learned from radiological emergency management exercises D.M. Rohrer (United States)	107
Lessons drawn in matters of preparation, conduct and planning of "off-site" nuclear security exercises on basis of three drills recently performed in France P. Ginot (France)	121

Off-site nuclear emergency exercises in Japan E. Urushihara, K. Tanizawa, M. Oshino and S. Fukuyuma (Japan) ...	130
--	-----

Planning, conduct and principal features of NPP emergency exercises in Switzerland M. Baggenstos (Switzerland)	141
--	-----

Session IV

International Exercise Programme

Chairman: D. ROHRER (United States)

Review of the emergency response exercise organised during the ERPET training course on off-site emergency planning and response for nuclear accidents P. Govaerts, M. Loos, A. Sohler, M. van Camp and Th. Zeevaert (Belgium)	153
Plan for international emergency exercises The NEA Expert Group on Nuclear Emergency Exercises	162

Session V

Conclusions and Recommendations

Chairman: J.O. SNIHS (Sweden)

Summary and Conclusions	171
Resumé et Conclusions	179
List of Participants	189

Introductory Note

C. Viktorsson
OECD Nuclear Energy Agency

An important component of the provisions which are made at nuclear facilities to mitigate the radiological consequences of a nuclear accident is the existence of adequate emergency planning and preparedness arrangements. If emergency arrangements are to remain effective, however, it is essential that they are regularly and thoroughly rehearsed.

Particular problems in applying emergency provisions may be experienced when the impact of a nuclear accident affects more than one country, due to differences in the respective organisational set-up, emergency zones, alert and intervention criteria, etc., as well as to different public information policies and public opinion climates. For this reason, the participants in an international Workshop on Technical Aspects of Emergency Planning, organised jointly by the NEA and the CEC in 1989 (proceedings published by the OECD, Paris, 1989), agreed to the usefulness of promoting international co-operation on off-site nuclear emergency exercises. It would serve as a means to contribute to improving the quality of national and international emergency arrangements.

The NEA Committee on Radiation Protection and Public Health (CRPPH) endorsed the recommendation from the Workshop and set up an Expert Group to prepare a programme of work in this field. The Expert Group identified two basic purposes of international co-operation in the area of off-site nuclear emergency exercises, namely:

- to improve the quality and the co-ordination of emergency response systems on a "regional" scale, in particular in the case where countries have borders in common; and

- to help in seeking consensus on approaches to the management of nuclear emergencies between countries which are not necessarily linked to each other with a common border or by being situated in the same region.

Furthermore, the Expert Group recommended a programme, endorsed by the CRPPH in September 1990, composed of two parts, the first of which concerns information exchange on national practices in the field of emergency exercises and on lessons learnt from these exercises, based on a collection of information and the arrangement of an information exchange Workshop. Apart from general information exchange, this first part would also serve the purpose of identifying important aspects to include in an international exercise programme, which constitutes the second part of the NEA programme.

The collection of information on national emergency exercise practices was carried out during the first half of 1991. A first summary of the responses received is presented in these proceedings. The Workshop was devoted to the completion of the information exchange programme and to assist in the preparation of the planned international emergency exercise programme.

The specific objectives of the Workshop were:

- to exchange information on national practices and lessons learnt from national, bilateral and regional exercises, as well as on plans for such exercises;
- to draw conclusions on basic criteria and "good practices" for the conduct of emergency exercises;
- to seek consensus on plans, criteria and methods for the arrangement of international emergency exercises.

The Workshop concerned the off-site part of nuclear emergency exercises and did not cover on-site exercises. It was based on invited papers covering the topics to be treated at the meeting. Significant time during the Workshop was devoted to a discussion on the NEA plan for the arrangement of international emergency exercises. As part of the Workshop the Dutch authorities presented the emergency arrangements in the Netherlands and gave some information on the staff exercise that was held at the same time as the Workshop. Some international observers were also invited by the Dutch authorities to follow the conduct of their field exercise.

The Workshop was chaired by Dr. J.O. Snihs, Deputy Director General of the Swedish Radiation Protection Institute (SSI). In addition, session chairmen were appointed to lead the discussions in Sessions II to IV.

The programme had been set up by the NEA Expert Group on Nuclear Emergency Exercises under the chairmanship of Dr. J.O. Snihs. Members of the Expert Group were Mr. J.A. Bond, AECL, Canada, Mr. M. Baggenstos, HSK, Switzerland, Mr. J.A. Driscoll, NII, United Kingdom, Mr. D. Rohrer, DOE, United States, Mr. Ciani, CEC, Mr. E. Asculai, IAEA, Dr. O. Ilari and Mr. C. Viktorsson, NEA Secretariat. Miss. F.E. Taylor, NII, United Kingdom and Mr. B. Weiss, IAEA, also participated in the preparation of the Workshop programme.

Note d'introduction

C. Viktorsson

Agence de l'OCDE pour l'Energie Nucléaire

Un élément important des mesures prises dans les installations nucléaires pour atténuer les conséquences radiologiques d'un accident nucléaire est l'existence de dispositions appropriées de planification et d'intervention en cas d'urgence. Pour conserver leur efficacité, ces dispositions doivent cependant faire l'objet de répétitions régulières et approfondies.

L'application de ces mesures peut susciter des problèmes particuliers lorsqu'un accident nucléaire a des incidences affectant plus d'un pays, en raison des différences existant dans leur contexte organisationnel, les zones visées par ces mesures d'urgence, les critères d'alerte et d'intervention, etc., ainsi que dans les politiques d'information du public et le climat de leur opinion publique. C'est pourquoi, les participants à la Réunion de travail internationale sur les aspects techniques de la planification d'urgence en cas d'accidents nucléaires, organisée conjointement par l'AEN et la CCE en 1989 (compte rendu publié par l'OCDE, Paris, 1989), sont convenus de l'utilité de favoriser la coopération internationale dans les exercices d'application hors site des mesures d'urgence. Ce faisant, on contribuerait à améliorer la qualité des mesures nationales et internationales d'intervention en cas d'urgence.

Le Comité AEN de protection radiologique et de santé publique (CRPPH) a souscrit à la recommandation de la Réunion de travail et constitué un Groupe d'experts chargé d'établir un programme de travail dans ce domaine. Ce Groupe d'experts a défini deux objectifs fondamentaux de la coopération internationale dans le domaine des exercices d'application hors site des plans d'urgence, à savoir :

- améliorer la qualité et la coordination des systèmes d'intervention d'urgence à une échelle "régionale", notamment dans le cas où les pays ont des frontières communes; et
- aider à dégager un consensus sur les méthodes de gestion des situations d'urgence nucléaire entre pays qui ne partagent pas nécessairement une frontière commune ou ne se trouvent pas dans la même région.

Le Groupe d'experts a en outre recommandé un programme, entériné par le CRPPH en septembre 1990, qui comporte deux parties : la première, ayant trait à l'échange d'informations relatives aux pratiques nationales dans le domaine des exercices d'application des plans d'urgence et aux enseignements tirés de ces exercices, serait fondée sur une collecte d'informations et l'organisation d'une réunion de travail en vue d'échanger ces informations. Outre l'échange d'informations générales, cette première partie servirait aussi à cerner les aspects importants à faire figurer dans un programme international d'exercices, lequel constituerait la seconde partie du programme.

Il a été procédé au cours du premier semestre de 1991 à la collecte d'informations sur les pratiques nationales. Un premier résumé des réponses reçues est présenté dans le compte rendu. La réunion de travail était consacrée à l'achèvement du programme d'échange d'informations et devrait permettre de faciliter la préparation du programme d'exercices d'application des plans d'urgence, prévu au niveau international.

La réunion de travail avait spécifiquement pour objectifs :

- d'échanger des informations sur les pratiques nationales et les enseignements tirés des exercices nationaux, bilatéraux et internationaux, ainsi que sur les plans visant ces exercices ;
- de dégager des conclusions sur les critères de base et les "bonnes pratiques" relatives à l'exécution d'exercices d'application des plans d'urgence ;
- de chercher à dégager un consensus sur les plans, critères et méthodes d'organisation d'exercices internationaux d'application des plans d'urgence.

La Réunion de travail ne portait que sur les exercices d'application hors site des plans d'urgence, à l'exclusion par conséquent des exercices sur le site. Elle

s'appuyait exclusivement sur les communications sollicitées sur les sujets inscrits à son programme. Au cours de la réunion, un temps important avait été réservé à l'examen du plan de l'AEN visant le programme international d'exercices. La contribution des autorités néerlandaises à la Réunion de travail consistait à présenter les mesures d'urgence adoptées aux Pays-Bas et à donner certaines informations sur les exercices effectués par le personnel, qui se sont déroulées au même moment que la Réunion de travail, ainsi qu'à la possibilité offerte aux participants de suivre la conduite de l'exercice sur le site.

La Réunion de travail était présidée par M. J.O. Snihs, Directeur Général adjoint de l'Institut national suédois de protection contre les radiations (SSI). Des présidents de séance avaient en outre été nommés pour diriger les débats des séances II à IV.

Le programme avait été établi par le Groupe d'experts de l'AEN sur les exercices d'intervention en cas d'urgence placé sous la présidence de M. J.O. Snihs et dont les membres étaient les suivants : M. M. Baggenstos, HSK, Suisse, M. J.A. Bond, EAEL, Canada, M. J.A. Driscoll, NII, Royaume-Uni, M. D. Rohrer, DOE United States, M. E. Asculai, AIEA, M. V. Ciani, CCE, MM. O. Ilari et C. Viktorsson, Secrétariat de l'AEN. Mlle F.E. Taylor, NII, Royaume-Uni et M. B. Weiss, AIEA, participaient également à la préparation du programme de la Réunion de travail.

SESSION I

OVERVIEW OF NATIONAL PRACTICES AND REGIONAL/INTERNATIONAL PROGRAMMES IN THE AREA OF OFF-SITE NUCLEAR EMERGENCY EXERCISES

CHAIRMAN

J.O. SNIHS
(SWEDEN)

Survey on National Practices and Lessons Learnt from Off-site Nuclear Emergency Exercises

C. Viktorsson

OECD Nuclear Energy Agency
Le Seine St. Germain
12 boulevard des Iles
92130 Issy-les-Moulineaux
France

ABSTRACT

Nuclear emergency exercises are considered to make an important contribution to the efficiency of emergency preparedness. Generally, the details of the emergency exercises are specified for each country and often for each site, reflecting the particular features that exist in relation to general emergency arrangements. The Chernobyl accident brought a new dimension into the arena of emergency arrangements - the international dimension. New conventions and revised international guidance have been issued and have been or are being included in national emergency plans. The OECD Nuclear Energy Agency decided in 1990 to promote international co-operation in the field of emergency exercises and has adopted a programme of work in this field. One component of this programme, which concerns a survey on national practices and lessons learnt from the planning and conduct of emergency exercises, is dealt with in this paper.

RESUMÉ

Les exercices d'urgence nucléaire sont considérés comme une contribution importante à l'efficacité des plans d'intervention en cas d'urgence. En général, les détails relatifs aux exercices d'urgence sont spécifiés pour chaque pays et souvent pour chaque site, reflétant les caractéristiques particulières qui existent par rapport aux dispositions générales des plans d'urgence. L'accident de Tchernobyl a apporté de nouveaux éléments dans ce domaine, à savoir, une dimension internationale des accidents nucléaires. De nouvelles conventions et des recommandations internationales révisées ont été publiées et ont été incluses ou sont en voie de l'être dans les plans d'urgence nationaux. L'Agence de l'OCDE pour l'Energie Nucléaire a décidé de promouvoir en 1990 une coopération internationale dans le domaine des exercices d'urgence et a adopté un programme de travail dans ce domaine. Un des éléments de ce programme, qui concerne une étude sur les pratiques nationales et les leçons tirées de la planification et de la conduite des exercices d'urgence, est traité dans cette communication.

INTRODUCTION

An important component of the provisions made at nuclear installations to mitigate the radiological consequences of a nuclear accident is the existence of adequate emergency planning and preparedness arrangements. If emergency arrangements are to remain effective, however, it is essential that they are regularly and thoroughly rehearsed. Periodic execution of emergency drills and exercises is, therefore, a regulatory requirement in countries with nuclear installations.

Particular problems in applying emergency provisions may be experienced when the impact of a nuclear accident affects more than one country, due to differences in policies and emergency arrangements.

For example, the NEA Committee on Radiation Protection and Public Health (CRPPH) agreed in September 1990 to the usefulness of promoting international co-operation in the field of off-site emergency exercises. The Committee identified two major purposes of such a co-operation;

- first, to contribute to the improvement of the quality and the co-ordination of the emergency response systems on a regional scale;
- second, to contribute to better mutual understanding internationally of the basic approach to emergency response planning adopted by various countries.

In particular, the Committee agreed to embark on a two step programme comprising first, the exchange of information in the field of off-site emergency exercises, including the collection of information and the arrangement of a workshop, and second, the organisation of emergency exercises on an international level.

The first component of the information exchange programme, dealt with in this paper, concerns information on national practices and lessons learnt from off-site emergency exercises in the NEA Member countries. The second component is the Workshop itself. The latter part of the programme, the international exercises, will be dealt with in Session IV of this workshop.

THE METHOD USED

A questionnaire, set up by the CRPPH Expert Group on Emergency Exercises in charge of preparing and executing the NEA programme, was sent to all Member countries of the NEA in January 1991. The questions concerned first, national practices on off-site emergency exercises and second, experience and lessons learnt from the off-site exercises conducted. Particular emphasis was given to this latter part, in view of the planned NEA programme on international emergency exercises. Finally, emphasis was given to questions concerning exercises relating to commercial nuclear power plants.

The responses are presently being reviewed and analysed, and the information in this paper is preliminary. Moreover, information from some countries is still missing. Due to the incompleteness and preliminary nature of the information, the paper is limited to a summary of some basic characteristics of the national practices in the field of off-site emergency exercises and of important lessons learnt from exercises conducted so far. The NEA is planning to issue at a later stage, a survey report which will include details about the exercise arrangements in the OECD Member countries.

THE RESULTS

The questionnaire consisted of two parts each comprising a small number of questions. The first part concerned the national practices on off-site emergency exercises and the second part, the experience and lessons learnt from planning and conducting such exercises.

1. National Practices on Off-site Emergency Exercises

The questions concerned:

- the type of off-site exercises conducted;
- organisations responsible for the planning, conducting and management of the exercises;

- accident scenarios used;
- major elements tested in the exercises;
- procedures for the exercises;
- involvement of the public;
- foreign participation, and;
- participation in bilateral/multilateral exercises.

Some of the above items are discussed below.

Types of exercises organised

It is evident from the responses that the arrangement of emergency exercises forms an integral part of the emergency planning schemes in the Member countries. Emergency exercises at various levels of participation are carried out frequently, from utility exercises to testing the operation of the on-site emergency arrangements, to large national exercises involving the whole chain of organisations with responsibilities in a nuclear emergency: nuclear utilities; local/regional/national authorities as well as public and private organisations having special functions in a nuclear emergency.

Emergency exercises are carried out in various ways, as table top, command post or field exercises. Table top exercises have proved particularly useful when one needs to test policy aspects of the emergency arrangements. These types of exercises are frequently carried out within organisations to test the procedures developed for carrying out the tasks that the particular organisation is responsible for, for example, the setting up and organisation of the response team, the staff performance and the decision making. Command post exercises provide a more realistic setting for the players and are therefore used to test the communication flow between organisations, the command and control from the emergency centre, etc. Field exercises, finally, provide an opportunity to put into practice a major part of the off-site emergency plans. Due to the extensive work involved in planning and conducting field exercises, they are arranged much less frequently than the other types mentioned above.

To illustrate the above, the practices in two OECD countries, the United Kingdom and France are given below.

In the United Kingdom, three levels of exercises have been defined (NEA 1989):

Level 1 (Site exercise), which is an exercise mainly concentrating on the operators' actions on-site and off-site but may involve the emergency services and other external organisations;

Level 2 (Off-site exercise), aimed to test the functions of each off-site centre dealing with the off-site implications of an emergency;

Level 3 (National), aimed at demonstrating the functions of the off-site centre and the role of the external agencies and organisations including central government.

In France, the exercises of particular interest in this context are the following (NEA 1989):

Technical exercises limited to the utility, the safety authority and the technical support body, with the aim to test the efficiency of the operating crew and support teams of the plant as well as that of emergency assessment teams of the utility and the authorities;

National exercises involving all actors that would be concerned in an actual situation. In this case the emphasis is on the initiation and the implementation of the off-site plans.

Similar exercise schemes exist in most countries with a nuclear power programme.

Accident Scenario

The scenario has to contain all the information necessary for the participants to react realistically to an hypothetical accident, such as the state of the installation, the type, the magnitude and timing of releases, the meteorological conditions, etc. The scenario should present a realistic and challenging situation to allow the participants to test their preparedness.

For countries using reference accidents as a basis for the nuclear emergency planning, typical source terms used are of the same order of magnitude as the reference accident. Countries using so-called severe accidents as a basis for planning, report the use of source terms comprising all the noble gases and significant parts of the core content of radiologically important volatile radionuclides such as cesium and iodine as well as to some extent less volatile

nuclides. Also, scenarios without a radioactive release are used frequently in order to test the preparedness to also handle threat situations.

In addition to simulated accident scenarios in domestic nuclear power plants, other types of scenarios are also used, such as scenarios in types of nuclear installations other than commercial nuclear power plants, transport accidents, accidents involving satellites, etc. Finally, some countries report that simulated accident scenarios of a foreign origin are also considered, for example involving releases in neighboring countries' nuclear installations.

In any case, it is evident that the accident scenario used in exercises has to reflect the objectives of the exercise and consequently, has to be adapted to the particular aspects tested in the exercise.

It is also pointed out by some countries that not only the release in itself but the emergency classification system adopted by the country for the purpose of alerting the responsible authorities about events in nuclear installations is used to drive the accident scenario. If the "site emergency" or the "general emergency" procedures are to be exercised or both, the accident scenario has to be adjusted accordingly.

Public Involvement

No country reports that they involve the general public in the exercises. What is done in several countries, however, is that some exercises include the objectives of testing the procedures and means for evacuating schools, day-care centres, or other public buildings. Additionally, the media is involved in some cases and press releases are issued, serving the purpose of reminding members of the public of the emergency arrangements existing to protect them from adverse effects should the need arise. Public involvement is normally taken care of by arranging for the simulation of questions from the public and is considered an important element in the exercises. It seems, finally, that some countries plan to involve representatives of the public more actively in future exercise.

Bilateral/Multinational Emergency Exercises

Within the framework of bilateral and multinational emergency arrangements in the field of nuclear safety and emergency response planning, a number of

initiatives have been taken to use emergency exercises as a tool to increase the mutual understanding of the various arrangements. Many countries use these agreements to invite observers from, or exchange contact persons with, the contracting party(ies).

Several countries report participation, or plans for participation, in bilateral/multinational emergency exercises.

Some examples of bilateral/multilateral co-operation:

- Switzerland, two exercises carried out with Germany, two more are being planned;
- United States, drills carried out with Canada;
- United Kingdom, drills carried out with France;
- Nordic countries, plans for joint Nordic exercise in 1993;
- European Community, preliminary test of the EC Urgent Radiological Information Exchange System, ECURIE;
- IAEA, first test of the IAEA Emergency Response System, ERS, carried out.

Finally, the NEA is presently preparing for arranging international exercises (see paper in Session IV).

2. Experience from Off-site Exercises

The questions that were asked concerned the principal lessons learnt from off-site exercises carried out so far. In particular the questions focussed on experience which could be of interest when planning multinational or international exercises.

A lot of experience exists within Member countries concerning the planning, conduct and evaluation of emergency exercises. Some of this experience is given below, in particular the one having a strong bearing on the plans for arranging international exercises.

Exercise Objectives

Exercise objectives provide both a basis for developing the scenario and a means for evaluating the response by the emergency organisation. It is therefore

essential that the exercise objectives are well defined, realistic and agreed upon in advance by the exercise participants. The more specific the objectives are, the easier it will be for the exercise evaluators to determine whether the objectives were met or not.

Exercise Planning

The exercise process is quite a complex and interrelated set of activities and functions involving many organisations. It includes the development of exercise objectives, the scenario, decisions on the participation in the exercise, the nomination of controllers and evaluators, preparation of detailed instructions, etc. Therefore, a good planning of the exercises is essential and a prerequisite for the conduct of useful exercises. It seems from the responses, that the planning process for large emergency exercises in most countries starts up to one to two years in advance of the exercise date, in some cases a longer time might be needed.

In an international context with the participation of several countries in an exercise the planning process will be equally important. It seems necessary, as is suggested by some countries, to establish a planning, or co-ordinating committee composed of representatives of all countries participating in the exercise. This committee should nominate subgroups to develop the scenario, the detailed instructions, etc. In planning exercises, one should not forget the economic costs involved in conducting exercises; this should be kept in mind when establishing the objectives of an international exercise. Finally, it is pointed out that to obtain maximum value from an exercise, it should involve as many countries as possible.

Accident Scenario

The accident scenario should be carefully developed to match the exercise objectives. If the objectives concern testing off-site response to nuclear accidents the accident scenario should include a release of radioactive substances to the environment. Depending on which aspects the exercise is going to test, the scenario has to be developed accordingly. It is also pointed out by several countries that it would be useful to include in an international exercise the testing of the decision making process concerning intervention criteria and levels. For this purpose, the scenario should be large enough to trigger certain protective actions related to sheltering and food stuffs, for example.

Units of measurements

Most countries responding, point out the importance of obtaining an agreement on the units of measurements to be used in an exercise, in particular in the reporting of the results of measurements by the various organisations involved. This would be even more important in an international exercise.

Means of Communication

Good means of communication are essential for effective co-ordination of actions in an emergency situation. Depending on the setting up of the exercises, this aspect is of paramount importance for the outcome of any exercise.

In view of the plans for international exercises, some countries point out the importance of exercising the procedures related to the IAEA Conventions on Early Notification and Assistance in emergency situations, and that one should consider including in an international exercise programme, the testing of certain aspects related to these conventions.

CONCLUSIONS

The NEA Survey on national practices and lessons learnt from the conduct and planning of nuclear emergency exercises show that exercises of various types are regularly carried out in Member countries and there consequently exists a bulk of experience today in this field. Exercises are considered important to test certain components of, or the full emergency preparedness for, managing off-site consequences of nuclear emergencies. One major message, or experience resulting from the review of the countries' responses to the NEA survey is that exercises in order to be useful have to be carefully planned and involve objectives that are well defined, realistic and thereby possible to evaluate. This experience, which comes from the carrying out of exercises on a national basis, will certainly also apply to any international exercise programme.

REFERENCES

NEA 1989 - *Emergency Planning in Case of Nuclear Accident, Technical Aspects, Proceedings of a Joint NEA/CEC Workshop in Brussels, 27-29 June 1989.*

THE IAEA EMERGENCY RESPONSE SYSTEM

B. Weiss, Co-ordinator
Emergency Assistance Services
Division of Nuclear Safety
International Atomic Energy Agency
A-1400 Vienna, Austria

ABSTRACT

As a result of the Chernobyl accident, the Early Notification and Assistance Conventions came into effect in 1986. These Conventions give the IAEA various responsibilities to carry out in a nuclear accident or radiological emergency. This paper describes the way in which the Agency visualizes its role in such emergencies, the documentation that has been published to implement this programme, and the Emergency Response System that has been developed over the past five years. In addition, the results of the first exercise of the IAEA's Emergency Response system are noted.

BACKGROUND

Almost from its inception in the 1950's, the IAEA has been aware that it would have a role in providing assistance to any Member State following an accident involving radioactive materials. However, during its early years, the Agency was not called upon to mobilize a response to accidents involving nuclear power facilities or relatively extensive radiological emergencies. Consequently, the Agency did not fully develop the concept of its role in an extensive radiological emergency.

Since 1979, however, there has obviously been an increased concern about adequate emergency planning and preparedness on the part of the Member States and the Agency. Following the Three Mile Island (TMI) accident and that at the Chernobyl nuclear site, increased attention was given to the Agency's role in major radiological events. As a result of TMI, the Agency's Board of Governors issued two advisory documents, INFCIRC/310, Guidelines for Mutual Assistance Arrangements in Connection With a Nuclear Accident or Radiological Emergency and INFCIRC/321, Guidelines on Reportable Events, Integrated Planning and Information Exchange in a Transboundary Release of Radioactive Materials. These advisory documents did provide comprehensive guidelines for use by States in negotiating agreements between States prior to or at the time of an accident. These documents, however, provided a less definitive role for the IAEA in such situations.

ROLE OF THE IAEA IN A RADIOLOGICAL EMERGENCY

The accident at the Chernobyl site resulted in the adoption in 1986 of the Convention on Assistance in the Case of a Nuclear Accident or Radiological Emergency and the Convention on Early Notification of a Nuclear Accident. These Conventions levy specific obligations and responsibilities on the States Parties that adhere to the Conventions*. In particular, it also defines a key role for the IAEA in the response to major radiological incidents. The specific roles of the agency that can be identified within the wording of the Conventions are simple, but pertinent.

The Agency will receive notification of an accident from a State and, if requested, inform other States which may be affected.

The Agency will receive and relay other information that may be useful to States or international organizations in respect to minimizing any radiological consequences.

The Agency will respond to requests for support from a State and, where necessary, act as "broker" between States.

The Agency will offer its "Good Offices" to co-ordinate assistance to those States requesting support.

With those specific roles in mind, the Agency began the development of an Emergency Response System (ERS) that would be capable of implementing the responsibilities given to the Agency. That process took some time, but now, the Agency believes it has attained a full Agency emergency response capability. There is still the concern about the capability of some countries to properly notify the Agency in the event of a serious radiological incidents since some of these countries have neither the infrastructure nor the communications capability to inform the Agency on a timely basis. The IAEA is committed to providing expert assistance to these countries to upgrade their capabilities. Until that is done, an integrated Emergency Response System will not be complete.

The Agency's efforts have focused on the necessary concepts, resources, documentation, and training to produce a coherent and comprehensive Agency programme. In that process, there has been a realization that given the IAEA roles specified in the Conventions, there are several other collateral roles that must be considered in the implementation of the Agency's ERS. These derive quite naturally from the primary roles defined in the conventions and, offer the support and assistance that most Member States have expected the Agency to provide.

Authenticate, screen, verify and compile information summaries for state authorities. It would not be useful during an emergency to provide States with information that is obviously wrong or is not the reporting State's official

* As of June 1991, there are 71 signatories and 58 parties to the Early Notification Convention and 69 signatories and 55 parties to the Assistance Convention.

and accurate data. Therefore, the Agency must, as a minimum, screen the information to be assured that the incoming messages are verified, authenticated, and make sense before sending them on to States and international organizations.

Prepare and distribute periodic information summaries for State authorities. Experience has shown that during a major radiological incident, an enormous amount of information and data are generated. Most States will have a difficult time handling such information. The Agency will develop its own internal information and data summaries which can be passed on to States who will be better able to utilize information that is organized and corroborated.

Co-ordinate press and other inquiries with the co-operation, and at the request of the State experiencing the emergency and other international organizations. The public's perception of how the nuclear industry responds to the next accident will in some measure be related to the consistency of the numerous pronouncements that will be provided from a multitude of locations. Therefore, the IAEA can help Member States by assisting the media in obtaining co-ordinated information from a familiar location.

Assist States in controlling rumours which, if true, could affect another State. From time to time, the media and the industry pipelines become filled with stories of radiological incidents which have little or no basis. Because of its unique position in implementing the Conventions and its extensive communications capabilities, the IAEA can contact the supposed affected State and serve as a factual source of information to dispel false rumours as quickly as possible and provide accurate details of actual incidents.

RECENT EXPERIENCES

On this latter point, Agency staff have been able to obtain accurate information quite quickly about inaccurate rumours of impending disasters distributed by some media. For example, these have involved the exaggerated radiological concerns about the accident at the Vandellos facility in Spain in 1989 and the beryllium fire at the Ust Kamenogorsk site in the U.S.S.R. in 1990. Recently, numerous rumours have sprung up about the Kosloduy facilities in Bulgaria and the nuclear power plant at Krsko in Yugoslavia. Between the Agency's Public Information staff and the Emergency Response Unit, the Agency has been able to provide timely and accurate information about the basis of numerous rumours which have overstated minor operational occurrences or unrelated events.

A great deal has been written and there has been much discussion about the TMI and Chernobyl accidents. These incidents have and will continue to shape the Agency's emergency response programme. However, there have been two incidents that intimately involved the IAEA and are representative of another type of incident that Member States and the IAEA will have to continue to deal with.

In 1987, a serious radiological emergency involving a fairly large caesium-137 teletherapy source occurred in Brazil. Several individuals died and there was extensive contamination and widespread public concern in Brazil about the incident. The initiating cause for this event was remarkably similar to one involving a cobalt-60 teletherapy source in Mexico four years earlier. The Brazilian authorities informed the IAEA of the accident soon after its discovery and requested assistance under the terms of the Radiological Assistance Convention. The assistance given included the provision of experts and equipment.

The other incident involved the exposures of three workers to cobalt-60 in a medical irradiation facility in El Salvador. One worker died, another has had two legs amputated and the third is back at work, but reported suffering from some symptoms that are related to his radiation exposure. In that case, the Agency was able to provide dosimetry and medical support to the team treating the workers while they were hospitalized in Mexico. In addition, after the patients were sent back to El Salvador, the Agency provided an IAEA staff expert to give medical consultation to the patients' physicians in El Salvador.

IAEA EMERGENCY RESPONSE SYSTEM DOCUMENTS

Any programme as highly visible as the Agency's ERS must document its procedures and provide detailed guidance to those who may use or benefit from the implementation of the Conventions. This has been done in several Agency documents that are designed to define, guide and implement the programme. These documents are:

Emergency Notification and Assistance Technical Operations Manual (ENATOM). A manual, which has been distributed to Member States, describes the overall Agency programme and the manner in which the Agency, States Parties, Member States, and relevant International Organizations interface under the Conventions. It is designed to provide the reader with sufficient information to understand how this international notification and information system works so that it can be incorporated into national emergency response plans. In addition, useful data on human and technical resources in the Member States and the IAEA are included.

Nuclear Accident/Radiological Emergency Assistance Plan (NAREAP). An internal Agency plan which is limited to the operations of the Agency. It provides the foundation for maintaining and activating the Agency's ERS. It describes in detail the basic conceptual framework of how the Agency will carry out its tasks and how it will be organized in a response to a radiological emergency.

Handbook of Emergency Response Procedures. These are the Agency operational procedures which describe in detail the manner in which each member of the Agency called upon in an emergency will carry out the tasks of their designated emergency response position. It covers such things as notifications, activation, message authentication and verification, record-keeping, communications, etc.

Guidance on International Exchange of Information and Data Following a Major Nuclear Accident or Radiological Emergency. A document which is expected to be published in 1991. This document is to inform Member States, international organizations, and the public as to how the various systems for exchanging essential information and data will be harmonized during an emergency. A major part of this document is the use of agreed-upon formats for the exchange of information and data to reduce chances of omissions, errors in scientific units, and translation difficulties under stress.

Concurrent with publication of this document, the Agency expects to provide Member States and international organizations with software programs to make the use of the suggested formats easy to use. The software programs are: 1) to encode data and information into the prescribed format; and, 2) to decode the formatted data, currently into English only, but later into French, Russian, or Spanish.

OPERATION OF IAEA EMERGENCY RESPONSE SYSTEM

In order to carry out its responsibilities under the Conventions, the Agency has also taken several key steps to assure that it is prepared to respond in an effective and timely manner. First, the Agency established an Emergency Response Unit in the Vienna International Centre. This dedicated facility contains the necessary communication and computer equipment plus the documents and data bases that are expected to be needed in a radiological incident. A professional and a full-time technical assistant maintain this facility, along with carrying out other related duties, such as programme

development, training for staff and Member States, provision of technical support to developing countries, exercising the Agency response capability, and data base development and maintenance.

In addition, to ensure readiness 24-hours per day, a corps of about 15 senior professionals serve as duty officers. These individuals are on-call at all times via telephonic pagers to receive emergency messages, determine the significance of the event and then contact senior Agency staff to decide what further immediate action the Agency should take.

Since the IAEA does not have telephone operator services 24-hours per day, seven days per week, and initial notifications could arrive any time by telex, facsimile or other electronic means, a system for receiving these messages and alerting the duty officers during these crucial hours has been developed. During off-duty hours, the focal point is the Vienna International Centre, Security Control Centre (VIC-SCC). Emergency telexes can be identified by an Agency computer and diverted to a telex machine located in the VIC-SCC. These Security Officers have also been trained to periodically scan messages that may arrive at the communications office during the night and contact the duty officers if anything of concern is identified.

Once it is decided that an event will require some response by the IAEA, there is a large number of IAEA staff who can be called upon to conduct the various tasks necessary to assure that the role of the IAEA discussed above is carried out.

Specific detailed procedures for each of the positions have been developed and several individuals for each position have been trained. The Agency is periodically conducting drills and exercises to reinforce the basic training.

Training is the key to any emergency response programme. Even the IAEA Director General, Dr. Hans Blix, and other senior managers of the Agency participate in emergency response training and exercises, along with numerous other professional and administrative staff of the Agency.

EXERCISE OF THE EMERGENCY RESPONSE SYSTEM

The overall Agency objective of procedure development, team building, and training is designed to assure that the IAEA is ready and prepared to carry out its responsibilities under the conventions. However, in order to demonstrate the Agency's

response capability when there is not an actual accident, the IAEA will conduct periodic comprehensive exercises involving a full response of the IAEA teams and participation by a number of Member States and international organizations.

Preparation for such exercises requires increased training of the staff, along with the development of the plans and documentation necessary to conduct a comprehensive exercise. Because of the importance of the media in any emergency, exercise scenarios contain certain public information situations that must always be faced in an actual event but are not always handled well, i.e., calming public concerns and anxieties; responding to media inquiries; determining the validity of rumours; conducting press briefings; etc.

The first exercise of the Agency's ERS was conducted in April 1990. This exercise was designed to test the ERS and its implementing procedures and involved the direct participation in Vienna of about 40 IAEA staff members, and representatives of two Member States and one International Organization. These individuals participated as players, evaluators, controllers and simulators*. In addition, there was participation outside of the Vienna Center in which five Member States, four other UN organizations, and the various Missions to the IAEA received exercise messages and responded, as appropriate.

The primary purpose of this initial emergency response exercise was to fully exercise the Agency's internal response system and its communications with Member States and other organizations in a realistic way in order to demonstrate the Agency's capabilities, provide training to ERS members, and learn where further improvements in the ERS can be made. In addition, to this purpose, the exercise had several other goals, which were to examine the interface between ERS groups and the Agency's role during an emergency.

A power reactor accident scenario provided the technical basis for the exercise. As this was the first IAEA ERS exercise, it was determined that participation during an actual reactor facility exercise with a Member State would not allow

*Controller: Monitors the flow of exercise to assure that exercise objectives are met and supervises the input of messages.

Simulator: Creates the simulated emergency by sending pre-scripted messages and/or spontaneous messages to players for groups that are not playing in the exercise.

Evaluator: Observes the actions and decisions of the exercise to later report what went well and what went poorly.

the flexibility needed to accomplish the exercise goals. Therefore, an exercise development staff created all the messages used to simulate communications with outside groups except for the few organizations that were actually playing in the exercise.

Control of an exercise is necessary to make certain that the exercise is conducted according to the stated objectives, the scenario, and the pre-scripted messages. The primary responsibility of controllers is to make certain that the exercise goes according to plan so that the goals and objectives of the exercise can best be achieved. The exercise was controlled using a relatively simple organization to monitor player actions and ensure that exercise play was appropriate and exercise objectives were met. A Lead Controller, located in the Emergency Response Unit, was in charge of the overall conduct of the exercise, managed the activities of the controllers, and had responsibility for approving any significant scenario changes during the exercise. Other controllers were located in the Telex Office, with the Director General and his senior advisory group, and with other senior managers. In addition, the Lead Controller was responsible for the activities of three sets of Simulators representing: (1) the media; (2) utility and industry technical staff and Member State technical organizations; and, (3) Member State political or non-technical organizations.

Feedback from players and evaluators indicated that this was a worthwhile and useful undertaking. Its primary accomplishment was establishing a baseline for evaluation of future performance. During this exercise, the published exercise purpose and goals were accomplished, and a successful system of exercise control and evaluation was developed and employed. In addition, a detailed list of lessons learned was developed and initiatives were taken to incorporate these lessons learned into the ERS. These lessons learned relate to such issues as improving the ERS organization, modifying operational procedures, upgrading resources and facilities, and correcting communications problems. A detailed list of these lessons learned is Appendix A.

In general, the methods chosen for conducting the exercise worked quite well. However, there were several suggestions for improving the next exercise. These related to such issues as improving the scenario, control of the exercise, conduct of the exercise, involvement of other organizations, and additional objectives.

Since the exercise, the ERS operational procedures have been revised to reflect the lessons learned and additional training has been provided to Agency staff. A second full participation exercise has been scheduled for January 1992 to evaluate the modified ERS and demonstrate the upgraded capability of the IAEA to respond to nuclear accidents or radiological emergencies.

SUMMARY

The IAEA has taken its responsibilities under the Conventions quite seriously. It has provided dedicated space, manpower, and resources towards developing a comprehensive Emergency Response System. That system has been implemented by procedure development, team building, and training and has reached a stage of full capability. In order to demonstrate that capability, the Agency has conducted a comprehensive exercise in the Spring of 1990 which involved several Member States and international organizations. The lessons learned from that exercise have been extremely valuable in further improving the Agency's capability to respond to a nuclear accident. A second exercise is planned for early 1992.

APPENDIX A

LESSONS LEARNED:

Organization:

1. The Agency role during a nuclear incident is not sufficiently defined.
2. ERS structure needs to be modified to more effectively operate in an actual emergency.
3. A consistent policy with respect to deployment of IAEA Staff to the Accident State needs to be developed.

Operational Procedures:

1. A Meeting agenda needs to be developed for each Incident Response Group (Executive Team) meeting to focus on the most important Agency issues.
2. Procedures must be developed so that initial notification is quick and essentially automatic.
3. Consideration should be given to the use of the building public address system during an emergency.
4. A closeout message should be provided to all organizations involved in an event or exercise.
5. Better procedures should be developed to consistently log, copy and distribute information and requests.
6. Continued improvement in the interface with World Meteorological Organization (WMO) and GDPS-Paris.
7. A policy and procedures should be developed for handling telephone information and/or assistance requests.

Resources and Facilities:

1. Reorganize the Emergency Response Unit (ERU) layout by function to provide more efficient operations.
2. Reevaluate the ERU software and computer distribution, and word processing capability.
3. Reevaluate the ERU task distribution.
4. Obtain additional ERU technical resources.
5. Establish a system to identify, deploy and manage the necessary Agency technical expertise in a nuclear incident.

Communications:

1. Develop a policy for the use of mainframe computer during a nuclear incident.
2. Procedures are needed for checking outgoing messages.
3. Develop and promulgate a policy on the continuous availability of emergency telephone lines.
4. Consideration should be given to upgrading the manner in which the Public Information office can more effectively respond to a nuclear incident.
5. Develop a procedure to provide the ERU with more timely information with respect to the verification of receipt of outgoing messages.

EXPERIENCE TO DATE WITH THE
EUROPEAN COMMUNITY URGENT RADIOLOGICAL
INFORMATION EXCHANGE (ECURIE) SYSTEM

G. Fraser
Commission of the European Communities
Luxembourg

ABSTRACT

The paper describes the background to the ECURIE system - its purpose, the constraints under which it has been implemented and the nature of the system which has thus evolved - before outlining the approach adopted to testing the system and presenting the results of exercises held to date.

RESUME

La note décrit les principes de base du système ECURIE, son but, les contraintes de sa mise en œuvre et les dispositions qui en découlent, les principes d'expérimentation sont présentés ainsi que les résultats des exercices effectués jusqu'à présent.

1. THE EC COUNCIL DECISION 87/600/EURATOM

The decision to establish Community arrangements for the early exchange of information in the event of a radiological accident was taken subsequent to the IAEA Early Notification Convention coming into force and both of these actions address the same problem - viz, the need for an established international system for the rapid transmission of information as demonstrated by the Chernobyl accident. Since all EC Member States have signed the Convention this appears at first sight to be a duplication of effort but in practice the EC system, ECURIE (European Community Urgent Radiological Information Exchange) goes appreciably further than the Convention since it :

- provides a more precise (if still extreme and not entirely clear-cut) criterion for initial notification;
- extends the range of accident situations which have to be notified;
- requires the exchange of information (via the Commission) between all twelve EC Member States;
- extends the range of information to be supplied;
- constitutes a legally enforceable system.

At the same time, however, the Community system has much in common with that of the Convention and the Commission has enjoyed and continues to enjoy close collaboration with the IAEA to ensure maximum compatibility of the two systems.

The complete text of the Council Decision is given in the Official Journal of the European Communities (OJ L371/76 of 30.12.87) but some additional information is given in the Appendix to this paper.

2. DESCRIPTION OF THE ECURIE COMMUNICATION SYSTEM

2.1 Telecommunications Facilities

The Council Decision having been taken it was necessary to establish a basic operational system rapidly. This system had to allow for a considerable flow of information being received by the Commission from individual Member States and the retransmission of that information to all Member States other than the original supplier.

There are nine official Community languages and to reduce possible errors of comprehension it was decided not to rely on oral (i.e. telephone) communications for transfrontier purposes. Electronic mail systems were attractive but would have required a standard system linking all national points of contact with the Commission to be agreed and installed. FAX machines were already widely available but, for the communications capacity required, a new bank of Commission machines each with its own telephone line and a switching unit allowing all machines to be accessed by a single telephone number would have been necessary; computer control would also be required for message capture, editing and redispach.

On the other hand the Commission already operated a continuously manned telex centre in Brussels providing computer-controlled multi-line facilities and this, together with continuously manned telex units in the Member States, provided an immediate basis for an ECURIE telecommunications system.

For emergency purposes, the entire system must of course be responsive at all times. Appropriate communications links between radiological emergency services and permanently manned telex offices had, therefore, to be established at national levels. Within the Commission an in-house electronic mail system interfaced with the telex computer is used for this purpose and the use of such an interface will facilitate the future development of automatic transfer of information received into a computered databank.

FAX transmission is retained as a back-up for transfrontier communications and also for information not readily communicable in telex form, e.g. contamination maps; telephone communication can be used for data transmission only as a final resort. Both remain available for internal purposes. Electronic mail providing direct communication with all points of contact is foreseen as a future option.

2.2 Procedures

A special code recognizable by the Commission telex computer is prescribed for all ECURIE telex transmissions which results in the telex being passed to a dedicated printer in the telex room. When the initial notification is received the telex operator telephones a member of the Radiation Protection Division (DG XI/A/1) who must report to his office; a copy of the message will have been automatically routed to this office by electronic mail and also, in the particularly case of an initial notification, by FAX. That person will then require to verify the origin of the message and, if valid, retransmit it by electronic mail to the telex computer for distribution to all Member States before calling in additional support. The Member States on receipt of the notification will also require to activate their radiological emergency response teams and then initiate the actions necessary to receive and communicate data on their individual national situations.

The problem of the nine official Community languages arises again in terms of the information to be conveyed. At the time ECURIE was being set up the IAEA was already working on a standardized question and answer format (coding) which would obviate much of the potential difficulty. This coding, now known as the Convention information Structure (CIS), was circulated to relevant parties in early 1989 in its original version, designed to cater for the types of information called for by the Convention. Since, however, the Council Decision requires additional types of information, an extended version has now been devised by the IAEA and the Commission acting in collaboration and the opportunity was taken to introduce additional revisions. Moreover, the original decoding PC software produced by the IAEA to facilitate interpretation of CIS-coded information is being updated to take account of the changes and the Commission is ensuring the production of compatible encoding software.

3. ECURIE EXERCISES APPROACH

From the arrangements described above several levels of testing the ECURIE system can be identified in order of ascending complexity:

- LEVEL-1 : testing of telex communications and recognition by the telex operators of incoming ECURIE messages;
- LEVEL-2 : LEVEL-1 tests extended to cover the initial contact between the telex services and the radiological emergency services which would allow the emergency response teams to be called together;
- LEVEL-3 : LEVEL-2 tests extended to cover (at least) the establishment of core emergency response teams in the Member States which will receive and decode CIS information from the Commission and also encode and transmit such information to the Commission.

In addition, the Commission has adopted the term Level-0 to describe in-house tests for the purposes of staff-training and checking the effects of any changes to the Commission's own facilities, e.g. new telex computer software.

For all exercise communications a standard format has been devised as shown, designed to ensure that there is no confusion between an exercise and a genuine alert.

```

[computer recognition code]
EXERCISE      EXERCISE      EXERCISE
ECURIE        ECURIE        ECURIE
[message]
EXERCISE      EXERCISE      EXERCISE

```

Figure 1: standard ECURIE exercise message format.

In the case of Levels 0 to 2 the initial notification "message" consists only of LEVEL 0, LEVEL 1 or LEVEL 2, as appropriate, repeated three times and this is transmitted by telex to the Commission in Brussels to be relayed to its Radiological Protection Division in Brussels and Luxembourg for processing and subsequent retransmission to national contact points; in the case of a Level 0, i.e. "in house", exercise this retransmission step can still be incorporated using the Joint Research Centre at Ispra. The contact point then replies with a "message" consisting quite simply of the word RESPONSE (again repeated three times) and, for

Level 2 only, the phrase CONTACT:--- UTC where the dashes are replaced by the time at which the radiological emergency response officer was successfully contacted. (Even across the Community there is a time difference of two hours and UTC is used to avoid confusion.) The receipt of the RESPONSE messages by the Commission concludes exercises at Levels 0 to 2.

Level 3 exercises can use the same standard format but the "message" can of course contain much more substantial information, which should be encoded in accordance with the CIS format. Not only is the organization of such exercises much more complex, it gives rise to a conflict of priorities. If such tests are to extend to analyzing and acting on the information received, the "information" should be largely self-consistent, which implies using a single hypothetical accident scenario to generate the data. However, even the Chernobyl accident had little or no effect on two of the EC Member States.

Correspondingly any accident scenario such as might normally be considered would probably implicate a few Member States at most, with the remainder having little to report other than background levels. This would imply that a whole series of exercises would be necessary, each with its own scenario, before all Member States could have a positive role and, with the work involved in preparing, executing and analyzing each exercise, it would take some years to complete a cycle providing for active participation of all national ECURIE response teams.

4. EXPERIENCE TO DATE

Numerous tests have been conducted by the Commission at Level-0 and have proved useful in identifying possible improvements to the technical arrangements and to the instructions for telex and radiological personnel. However, they have not as yet been introduced at regular intervals of a frequency such as to obviate all need for additional tests to check that the electronic-mail software, the links between Luxembourg and Brussels and the telex interface in Brussels are operating correctly. For this reason further tests have been carried out from time to time, which consist of addressing a telex (the content of which is irrelevant) via the electronic-mail system for despatch to the Commission's offices in Luxembourg.

Three LEVEL-1 tests have been conducted in the past year mostly involving the Commission central organization and a total of 15 contact points; two Member States have two contact points each (since the lead department will depend on whether or not an accident is within the national territory) and the Commission's Joint Research Centre at Ispra is also included, since it will be responsible for technical support to ECURIE within the Commission.

On the first occasion two Member States had difficulties in telexing Brussels; it is presumed this was due to problems with international lines and the problem has not recurred. Also, some Member States' communications did not allow automatic computer recognition due to the code being entered in an incorrect fashion or for other reasons but again this problem has been largely overcome; in such cases the telex must await recognition during periodic visual inspections by the telex service, which can cause a delay of up to 30 minutes or so. However, the system can never operate

perfectly to the extent that manual input via keyboards is necessary, particularly input of the Brussels telex number. (The Commission does not in fact send a separate acknowledgement of each message received but messages to be relayed to the other points of contact will be sent to all points of contact at the same time and hence the return of the message to its originator will demonstrate its safe reception and treatment; this aspect will not appear, however, until Level-3 is attained).

Subsequent to these tests the first LEVEL-2 exercise took place. As stated previously such exercises extend Level-1 tests to include contact between the receiving telex service and the national radiological protection authority prior to the reply to the Commission. In practice some Member States are understood to have implemented this requirement even at LEVEL-1 and, within the Commission, all exercises are effectively at LEVEL-2 in that the first step is always to transmit a telex to the Brussels centre. This centre then requires to contact an ECURIE official who will receive the telex and initiate the transmission to all points of contact. The times required in this first exercise for the various steps of the overall procedure are given below:

Receipt of initial telex by electronic mail in Luxembourg	20 m
Despatch of retransmission instruction	20 m
Telex transmission to contact points (one persistently busy line - 1h35m)	10-25 m
Receipt in Brussels of telex response (one faulty telex transmitter - 1h20m)	5-45 m
Receipt of response by electronic mail in Luxembourg (three automatic recognition failures - max. 33 m)	7-26 m

Figure 2: duration of different stages of a LEVEL-2 exercise.

In total the procedure took 3h10m, the minimum time to completion for a single point of contact being 1h15 minutes and the exercise being 70% complete (11 of the 15 contact points) within two hours. As noted previously, the response telex should give the time of contact with the radiological duty officer in UTC; only two contact points failed to observe this requirement. Actual delays between receipt of the Commission's telex and reaching the duty officer were 10 minutes or less in 11 of the fifteen cases, with a maximum of 34 minutes.

It can be further observed that the time taken from the despatch of the initial telex to the Commission until it came to the attention of the national radiological duty officer was less than one and a half hours in all cases.

To date one further Level-2 exercise has been held, immediately before which it was discovered that it would coincide with modifications to and testing of the automatic link between the Commission telex and electronic mail systems which could in turn render this link temporarily inoperable.

Nevertheless, it was decided to continue with the exercise as planned, on the basis that FAX communications between the telex centre and radiation protection staff had already been foreseen as a fall-back provision, even although the absence of detailed instructions for this case could be (correctly) anticipated as a source of additional delays. In practice the time taken between despatch of the initial telex to the Commission and beginning the onward telex transmissions to the points of contact took almost 2 hours instead of the 45 minutes required in the first exercise. However, the latter transmissions were then completed within 10 minutes and 70% of the responses were received within one hour; all but one of the responses (some 5 hours delay) were received within 1.5 hours.

The first LEVEL-3 exercise is still at the planning stage. In order to have all Member States actively involved, there will be no overall accident scenario and hence no consistency between the monitoring data communicated by the different countries. However, since the main purpose will be to provide a more sustained exercise involving the encoding, transmission and decoding of a series of messages using the CIS in real time, this lack of homogeneity is of no great importance.

More significant will be control of the amount of information to be conveyed, in that the exercise could otherwise lead to a breakdown of the procedures due to an artificially excessive data flowrate. In effect, in the event of a real accident, significant contamination would in all probability be limited to a few Member States (or at worst would spread more widely over a period appreciably longer than the timescale of the exercise). Moreover, it is an aim of the exercise to involve as many data types foreseen by the CIS as possible, whereas in reality these data types could be expected to evolve gradually for any one geographical area as the results start to become available. For each Member State to be generating appreciable amounts of significant data of all types within a period of a few hours would be unrealistic. Instead, a limited amount of data, as diverse as possible in its nature, will have to be agreed in advance for each Member State in order to avoid a grossly exaggerated flowrate and the creation of non-existent problems.

As stated previously the nature of the data coming from individual Member States will not allow any attempt at a collective, self-consistent analysis. Other than telex transmission and reception, the response of each Member State could be limited to assembling a core response team at the appropriate emergency centre which would receive raw data for CIS encoding and despatch by telex and which would also require to decode information received from other Member States in the Commission. Nevertheless, the Member States are being encouraged to extend their response to simulate, for example, the setting in motion of emergency monitoring schemes, activating related national emergency support centres, the exchange of data with these centres and the transfer of incoming Community data to databanks intended for this purpose.

For practical reasons, the exercise is being planned in two parts on separate, not necessarily successive, days. In the first part the Commission will distribute standard information in clear language to all Member States sufficient to allow real-time encoding on an accident notification and subsequent despatch by telex to the Commission. The second part will commence with a telex containing an encoded notification from the Commission; Member State core response teams will require to decode this and will then receive from their local exercise managers a series of raw

environmental monitoring data for encoding and despatch. In effect the first part will be a trial run of real-time encoding and transmission, encoding (even with the software) imposing a more active role on those concerned. Moreover, the notification having already been taken up in the first stage, the second stage will be better able to concentrate on providing comprehensive and repeated coverage of the various environmental monitoring data-types within a reasonable timespan.

The dates for the first exercise, however, are still some time away. With the gradual development of ECURIE procedures, the CIS itself and now multi-lingual software for the CIS, it only recently became possible to envisage preparing a useful, practical manual. The majority of Member States wish to have this manual compiled and formally agreed (i.e. in the various official languages) at Community level together with a subsequent period for staff training before proceeding to a Level-3 exercise. This work is now proceeding but it is estimated that the first such exercise will only be possible towards the end of 1992.

5. CONCLUSIONS

Using relatively simple technology it has proved possible to set up a rapid communications system. Tests to date have demonstrated that this can ensure passage of an accident notification within one and a half hours - at least within normal working hours. Future tests will be required to evaluate the initial response time out of office hours and also the encoding, transmission and decoding of data using the CIS, adopted both by the Community and the IAEA, and associated software. Consideration is also being given to organizing joint exercises, with the IAEA.

For the longer term the use of electronic mail will be investigated which, apart from increasing the speed of communications, should also facilitate the electronic capture and storage of incoming data for subsequent analysis.

Some requirements for the ECURIE system
arising from the EC Council Decision

The system will be activated whenever an EC Member State decides to take widespread countermeasures following:

- (a) an accident in its territory involving facilities or activities referred to below from which a significant release of radioactive material occurs or is likely to occur; or
- (b) the detection, within or outside its own territory, of abnormal levels of radioactivity which are likely to be detrimental to public health in that Member State; or
- (c) accidents other than those specified in (a) involving facilities or activities referred to below from which a significant release of radioactive material occurs or is likely to occur; or
- (d) other accidents from which a significant release of radioactive materials occurs or is likely to occur.

The facilities or activities referred to above are the following:

- (a) any nuclear reactor, wherever located;
- (b) any other nuclear fuel cycle facility;
- (c) any radioactive waste management facility;
- (d) the transport and storage of nuclear fuels or radioactive wastes;
- (e) the manufacture, use, storage, disposal and transport of radioisotopes for agricultural, industrial, medical and related scientific and research purposes; and
- (f) the use of radioisotopes for power generation in space objects.

A Member State notifying an accident shall include, as far as practicable and appropriate, the following information updated at appropriate intervals:

- (a) the nature and time of the event, its exact location and the facility or the activity involved;
- (b) the assumed or established cause and the foreseeable development of the accident relevant to the release of the radioactive materials;
- (c) the general characteristics of the radioactive release, including the nature, probable physical and chemical form and the quantity, composition and effective height of the radioactive release;

- (d) information on current and forecast meteorological and hydrological conditions, necessary for forecasting the dispersion of the radioactive release;
- (e) the results of environmental monitoring;
- (f) the results of measurements of foodstuffs, feedingstuffs and drinking water;
- (g) the protective measures taken or planned;
- (h) the measures taken, or planned, to inform the public;
- (i) the predicted behaviour over time of the radioactive release.

A Member State receiving notification of an emergency shall:

- (a) promptly inform the Commission of the measures taken and recommendations issued following the receipt of such information;
- (b) inform the Commission, at appropriate intervals, of the levels of radioactivity measured by their monitoring facilities in foodstuffs, feedingstuffs, drinking water and the environment.

PLANS FOR INTERNORDIC EMERGENCY EXERCISES

E. Stranden
Norwegian Nuclear Energy Safety Authority
P.O.Box 750 Sentrum, N-0106 OSLO, NORWAY.

T. Bennerstedt
TeknoTelje
P.O.Box 2336, S-760 10 BERGSHAMRA, SWEDEN.

ABSTRACT

Objectives and plans for an internordic off-site emergency exercise are presented. The exercise will involve decision makers and advisers from nuclear emergency organisations in all the Nordic countries; Denmark, Finland, Iceland, Norway and Sweden. The project is organised through the Nordic Committee for Nuclear Safety Research (NKS). The exercise will be divided into two parts. The first, scheduled for January 1993, deals with the threat of an accident and immediate response actions following that accident. The second part is planned for September/October 1993 and comprises a fallout situation 3-4 days after a major accident.

RESUME

Ce report présente les objectifs et les plans d'un exercice internordique. L'exercice implique des représentants des autorités et leurs conseillers, provenant de l'organisations de sécurité nucléaire de tous les pays nordiques, Danemark, Finlande, Islande, Norvège et Suède. Le projet est organisé par le Comité Nordique de la Recherche de Sécurité Nucléaire (NKS). L'exercice sera réalisée en deux étapes séparées. La première aura lieu en janvier 1993 et traitera une phase précoce (menace). La seconde, en septembre/octobre 1993, traitera la situation trois à quatre jours après un grave accident.

1. INTRODUCTION

In the mid-seventies, a Nordic (Denmark, Finland, Iceland, Norway, Sweden) co-operation in nuclear safety research was organised under the Nordic Liaison Committee for Atomic Energy (Nordisk kontaktorgan for atomenergispørsmål, NKA) through its Nordic Committee for Nuclear Safety Research (Nordisk komite for kjernesikkerhetsforskning, NKS). This co-operation was financed through Nordic Council of Ministers.

The programme for research activities in the period 1990-1993 is financed through a consortium of reactor safety and emergency authorities in the Nordic countries. NKS is the executive body for the programme which contains four main project areas: Radioecology, nuclear waste and decommissioning, reactor safety and emergency.

Under the emergency programme, one of the tasks is to plan and perform an internordic emergency exercise taking place at the end of the programme period. In this paper, the objectives and preliminary plans for the exercise are discussed.

2. OBJECTIVES

The main objective of the exercise is to test and harmonise Nordic decision making in an emergency situation.

From this the following secondary objectives emerge:

- To test the methods of co-operation between the Nordic countries.
- To test the contacts with countries outside the Nordic countries and with international organisations.
- To improve the ability of the Nordic countries to cope with an emergency situation with a large ground deposition of radionuclides.
- To exercise the national emergency organisations in a Nordic perspective.
- To supply sufficient background for necessary adjustments of the national emergency organisations concerning:
 - Organisational structure.
 - Ways of co-operation.
 - Liaison.
 - Manpower.
 - Other resources.
 - Information (international, Nordic, national).
 - Policy for decision making.

3. PARTICIPATION

The exercise is mainly aimed at decision makers and advisers of the five national emergency organisations. The Nordic perspective requires a certain minimum number of participants from each country. How large this number will be depends on the national organisation.

4. TYPE OF EXERCISE

The exercise is planned to include both an acute scenario and a scenario taking place a few days after a major accident.

4.1 The acute phase

It has been decided to include an acute scenario for the following reasons:

- It is of major importance to be able to establish the right contacts, check the available communication channels and agree on common policy for decision at a very early stage of an accident; preferably even prior to an accident.
- The Nordic resources should be coordinated as early as possible.
- Background information and reference material should be compared and checked.
- Acute counter measures must be decided on and planned, and information must be prepared.
- The national organisations must be mobilised.
- Contacts with international organisations and non-Nordic countries must be established.
- At an early stage, each country must observe the development in the other Nordic countries. This includes counter measures, plans, time schedule and use of resources.
- The needs for information to mass media and to the public must be analysed.

In order to fulfill these goals, the exercise must take place simultaneously in all five countries.

The scenario should be designed so that all the Nordic countries will be adequately involved. The primary goal is to test and train reactions to an external threat. The scenario should be designed to adequately involve all Nordic countries. The exercise will start by rumours suggesting that something

potentially dangerous is happening somewhere. Such rumours will involve very uncertain and contradictory information on the radiological situation, safety aspects etc. The emergency organisations will not know how serious the situation is, and they must start to search for more information and try to establish a picture of the development. During this situation there will be a strong pressure from the public and mass media demanding information. Gradually, more information will reach the emergency organisations and a picture of a real emergency will appear. The situation must be analysed and plans for counter measures must be discussed.

Key questions that will emerge are:

- What should be done and what can be done?
- How seriously will the country be affected?
- What is the view of the neighbouring Nordic countries?
- What parts of the country will be affected?

4.2 The late phase

The scenario of this phase brings the participants to the 3rd or 4th day after a serious accident. The main reason for this type of exercise is to test decision making in a given fallout situation, including a reevaluation of counter-measures already taken during the first 2 - 3 days. It is important to see if all five countries respond in the same way to a given situation, as far as risk assessment and counter-measures are concerned.

National deviations may be justified by differences regarding geography, demography, agriculture, and other relevant factors. It is important that these differences be disclosed and explained.

During the late phase, all countries will be given similar scenarios. No reference will be made to the source term. The countries will not be able to communicate with each other in this phase, since the exercise will be held at different times in the various countries.

The scenario includes a 3 - 4 days old deposition of radio-nuclides covering parts of the country. Some countermeasures have already been executed. This scenario has no connection whatever to the threat dealt with in the acute phase.

The played time of the year will be chosen to create maximum problems with regard to tourism, agriculture etc.

The problems presented offer no simple, clear-cut solutions. There may be several rational and justified responses to a given problem, depending on which factors are considered most important in the particular case.

The participants will be given the scenario, including counter measures that have been performed during the first days. Then the participants will take over the work. They will have to do their own evaluations, ask relevant questions and try to obtain the information needed to make relevant decisions.

Key questions may be:

- Must groups of people be evacuated?
- May evacuated groups be sent back?
- Are further restrictions on farming, travels etc. needed?
- May earlier restrictions be abolished?

Some key facts are presented at the start of the exercise. More information is given later or may be obtained from the exercise leaders playing different organisations.

5. PROJECT ORGANISATION

The preparations for the exercise are done through the following project organisation:

The project leader (E. Stranden) is responsible and reports to NKS. Key persons from all the Nordic countries constitute a project group that will help the project leader especially in national questions.

Directly under the project leader, T. Bennerstedt serves as a Nordic co-ordinator. He plans the practice work and supervises national preparations in all five countries.

Each country has appointed a national co-ordinator. He is responsible for all practice arrangements, together with the national organisations involved. He also liaises with the Nordic co-ordinator.

The two scenarios are being developed by two consultants in close co-operation understanding with the project leader.

For the actual running of the exercise, an exercise group will be formed. In the acute phase, national exercise groups will be needed in addition to the central group.

After the exercise, an evaluation group will go through the exercise and compile a report. All suggestions for improvements will be based on the experiences of the exercise.

6. TIME SCHEDULE

The exercise concept has been discussed with NKS and the different national organisations, and there is a general agreement that the work shall proceed. The project organisation has been set up, and some detailed planning has started. During the fall of 1991 a detailed time schedule for the different stages of the work is to be discussed and agreed upon.

The scenarios are presently being prepared by Scandpower A/S, Norway (the acute phase) and Risø National Laboratory, Denmark (the late phase).

The acute phase is planned for January 1993 and the late phase will take place in September/October 1993. The last ten months of the year will be spent evaluating the exercises.

SESSION II

TECHNICAL AND ORGANISATIONAL ASPECTS OF THE CONDUCT OF EMERGENCY EXERCISES

CHAIRMAN

B. WEISS
(IAEA)

NUCLEAR EMERGENCY EXERCISES IN CANADA

F.B. Ali
Emergency Planning Ontario
Ministry of the Solicitor General
Toronto, Ontario (Canada)

ABSTRACT

The practice followed in planning, preparing and conducting offsite nuclear emergency exercises in the Province of Ontario, Canada, is described. In addition, some of the main issues that arise during this process are discussed, as well as Canadian experience in dealing with them.

The planning process starts with basic decisions on the aim, scope and duration of the exercise. It proceeds through selection of the exercise objectives and participants, the development of scenarios and incident lists culminating in a master scenario and a master incident list, and, finally, the production of control inputs. Preparations include the setting up of a planning organization, making arrangements for exercise control and evaluation, and the required logistics. Some aspects of international exercises are also covered, based upon experience with joint exercises with the U.S.A.

RÉSUMÉ

La pratique suivie par la province de l'Ontario, Canada, dans la planification, la préparation et la conduite d'exercices aux environs d'une centrale nucléaire en situation d'urgence est décrite. Aussi, quelques-unes des questions les plus importantes qui surgissent durant ce processus sont discutées, ainsi que l'expérience canadienne pour traiter ces questions.

Le processus de planification commence avec les décisions de base sur le but, la portée et la durée de l'exercice. Il se poursuit avec la sélection des objectifs de l'exercice et celle des participants, et avec le développement de scénarios et de listes d'incidents. Il se termine par la production d'un scénario principal et d'une liste principale d'incidents, et finalement, par la production des entrées de contrôle. La préparation inclut l'établissement d'un organisme de planification qui s'occupe des arrangements pour le contrôle et l'évaluation de l'exercice, de même que de la logistique requise. Quelques aspects sur les exercices internationaux, basés sur des exercices en collaboration avec les États-Unis, sont aussi abordés.

INTRODUCTION

This paper describes the practice of planning and conducting offsite nuclear emergency exercises in the Province of Ontario in Canada. Ontario contains 20 power reactors and 2 large research reactors located in four multi-unit sites, comprising about 90% of the nuclear power reactors in the country. In addition, there is a power reactor in the USA which is within 16 km (10 miles) of Ontario, and is therefore treated, for planning purposes, on the same level as nuclear stations within Ontario.

In addition to outlining the process that is normally followed in preparing and running exercises, this paper also discusses a number of issues that normally arise in such an endeavour, and how we deal with them.

THE PLANNING PROCESS

The procedure followed in planning an exercise is illustrated in Figure 1. The process starts at the top of the pyramid and works its way down in the steps shown. The shape of the figure indicates that each succeeding step involves an increasing amount of work, and hence requires the allocation of correspondingly greater time in the planning schedule.

This process is generally followed for all types of exercises, though the workload obviously varies with the nature and complexity of the exercise. The various steps shown in Figure 1 are discussed below.

Basic Decisions

These include the type of exercise to be run, its aim, scope, duration and dates.

The considerations affecting the type of exercise that can be chosen are covered in other papers being presented at this workshop and, thus, will not be discussed further.

The aim of the exercise is clearly formulated at the commencement of the planning process. The various aspects, some or all of which can be adopted as parts of the aim, are: the testing of plans, procedures and organization; demonstrating or/and practising them; and providing a training experience for the participants.

The scope of the exercise is determined by the aim, and involves a decision as to which plans, procedures and elements of the emergency management organization are to be involved in the exercise. A major issue that arises here is whether the exercise should be only an offsite one or a combined onsite-offsite exercise. Having tried both, we have come to the conclusion that a combined onsite-offsite exercise imposes too many constraints on scenario development. The inevitable compromises and lack of realism that have to be introduced into both onsite and offsite scenarios result in the benefits of such an exercise being outweighed by these limitations.

The duration of an exercise depends on its scope. One issue faced by us was whether to continue a two-day exercise during the intervening night. Our experience has been that the minor advantage of practising realistic shift changes is not worth the extra burden placed on scenario development and the cost involved in overnight exercise play.

Objectives and Participation

The exercise objectives are derived from the aim and scope selected for the exercise. They define the goals that the exercise must be designed to achieve. A comprehensive list of possible exercise objectives is given in Table I; the objectives actually chosen for a particular exercise would vary depending on its type, aim and scope. Only a full-scale exercise lasting several days would be able to encompass all the objectives listed in Table I.

The next step is to decide upon participation in the exercise, i.e. the organizations and agencies who should take part in the exercise, and the extent of their participation. The requirement as to who should be involved follows from the scope and objectives of the exercise. However, actual participation will depend on negotiation with the identified agencies, and sometimes it is not possible to obtain their agreement to take part, or at least to the extent required. In such a case it usually becomes necessary to revise the scope and objectives initially selected for the exercise. Other options are to have some parts of the emergency organization function in only a token manner in the exercise, or be entirely simulated by the control organization.

Two special issues that usually arise in planning such exercises relate to the participation of the public and the media. Certain exercise objectives (e.g. those relating to protective action) can only be fully achieved with the participation of members of the public. We believe that the logistics and potential problems arising from an attempt to involve the general public outweigh any benefit that may be gained. However, a partial solution can usually be found by using school children or adult volunteers to represent the public in certain specific activities, such as being processed in a reception centre.

Any effective testing of the emergency information function requires participation of the media or their surrogates. Our practice is not to involve real media people because of the difficulty of interesting them in playing a role in the exercise; they tend to treat the exercise itself as a news story, and there is a good chance that some of them will try to sensationalize one or two aspects, usually negative, of the exercise.

We have tried two ways of meeting this need. One is to engage a few consultants with media experience to represent the entire media presence. While this usually provides good quality intervention, it cannot adequately give the feel of the mass presence and pressure of the media that would exist in a real emergency.

Another method is to involve an entire senior class of journalism students from a college. We normally receive an enthusiastic response to such a proposal from their instructors, who consider it to be valuable practical training for the students. With their assistance, the participation of such a large number of "journalists" can be controlled and managed. However, we have found that while this method can provide the realism of large-scale media interest in such an event, it is difficult to duplicate the intensity and sharpness of the media impact in a real emergency. Perhaps the best solution is to combine both methods.

Scenarios

The process of developing the exercise scenario usually involves three steps:

- preparing an outline scenario, which contains the major events that should occur during the "emergency" in order to achieve the objectives set for the

exercise. These events include both those to be simulated or staged by the control staff, and those likely to be undertaken by the exercise players; it is often necessary to postulate more than one possible action by the players at various stages. A time or period is assigned to each event; in many cases this will be tentative.

- developing sub-scenarios, based on the outline scenario, for the various areas and activities involved, e.g. the nuclear station, meteorology, traffic control, emergency social services, emergency information, municipal services/departments, etc. These sub-scenarios contain the major events relating to each area/activity that should occur within the context of the overall situation as it develops according to the outline scenario.
- combining the outline scenario and sub-scenarios into a master scenario for the exercise. This process requires co-ordinating the sub-scenarios with each other, and may often involve making changes in events and/or their timings. The times of events are now much firmer than they were in the outline scenario or the sub-scenarios.

Even though we may not be having a concurrent onsite exercise, the nuclear station scenario is developed in sufficient detail to enable the emergency management organization to carry out assessment of the "accident", which is an important exercise objective.

A perennial problem in offsite exercises is how to play the meteorological scenario. Our practice is to select a day or days in the same season in a previous year which experienced conditions appropriate to the overall scenario. The disc containing the recorded measurements for this period is loaded onto the main weather computer for the exercise which provides "real time" data whenever accessed by the players. Meteorological reports from other stations, such as the nuclear site, are tailored to fit the recorded data.

Another issue that often arises is that of time compression. We have found that while it is relatively easy to jump forward one or more days, jumping a few hours can cause considerable difficulties. So long as the bridging is carefully planned and executed, it is quite feasible to stop the exercise at some point, and then restart it later with scenario-time being clock-time one or more days later. However, running an exercise with scenario-time being different from clock-time is very difficult, and should only be attempted if absolutely unavoidable, and then too perhaps only in the controlled conditions of a command post or operations centre exercise.

Incident Lists

The incident list fleshes out the scenario. An incident is an action to be taken by controllers or one that is expected to be taken by players; however, of the latter only those are included in the incident list which would trigger other player or controller actions, and thus are necessary for the development of exercise play. Since the scenario contains only major events, each scenario item normally requires or/and leads to a number of incidents.

An incident list is developed for each sub-scenario. These are then combined (in order of time of occurrence) in a master incident list. To this list are added other appropriate incidents to smooth out and add realism to the exercise play.

A useful tool in finalizing an incident list is a time chart, which plots incidents on time lines for each centre or group taking part in the exercise. This will show up periods for each centre/group where too much activity is being concentrated, or where there is too little. In the former case incidents can be spread out more; in the latter more incidents can be added. A time chart also helps in ensuring that linked actions are being placed in the correct order.

Exercise Inputs

The next step in the planning process is to convert the incidents to be initiated by exercise control staff into exercise inputs. These are the actual messages (in the form of information, data, periodic reports, directives, requests for information or direction, etc.) that are to be transmitted by controllers to the players during the exercise. The transmission is to be done in the appropriate form, verbal or written, and using the appropriate means: telephone, radio, facsimile, or personally. When completed and co-ordinated, the inputs are sorted by controller and recorded on the appropriate controller's input log.

We believe that it is prudent to also prepare and hold in reserve a set of inputs which cover certain crucial transactions between players which materially determine the future course of the exercise. For example, technical projections of the offsite radiological effects of the accident are a major factor affecting decisions on protective measures. If, for some reason, at some point during the exercise the technical players come up with numbers significantly different from those upon which the exercise scenario was based, it may become necessary for controllers to substitute control data for what was produced by the players in order to ensure that the exercise play is not derailed or diverted. This would only be possible if such input data had been prepared in advance.

EXERCISE PREPARATIONS

The various preparations that are required in connection with an exercise are outlined below. They are also illustrated in Figure 1 as the base of the planning pyramid, indicating the close interaction of the two activities, which take place concurrently and feed into each other continuously.

Planning Organization

The planning process described above needs an organization to carry it out: an exercise planning group headed by an Exercise Director. The size of the group depends on the amount of planning work involved, which in turn is determined by the type and scope of the exercise. A full-scale exercise usually requires a number of specialist sub-groups, each of which develops one of the sub-scenarios and its associated incident list mentioned earlier. In such cases, it is generally necessary to constitute a co-ordinating committee which brings together the convenors of the sub-groups, and is responsible for the master scenario and the master incident list.

Control Organization

The control organization develops exercise play according to the planned scenario by providing inputs into various elements of the exercise organization, and by receiving output from this organization and then responding with appropriate feedback. Its composition depends on the composition of the exercise organization, i.e. which parts of the emergency management structure are being exercised. All those other parts of this structure which are not being exercised and which would normally interact during an emergency with the elements being exercised are represented by the control organization. In addition, it represents other bodies which would also so interact.

The size of the control organization also depends on the degree of interaction required to take place according to the exercise scenario. One controller could represent several elements of the emergency organization which did not have too active a role in the scenario. On the other hand, an element or a function which was quite interactive might require several controllers to represent it during the exercise. As an example, Figure 2 shows the exercise and control organization for one of our large-scale exercises.

It is usual to have the exercise planners act as controllers during the exercise, with the Exercise Director acting as chief controller. Where a number of controllers are representing one element or activity, it may be necessary to appoint a head controller to oversee and co-ordinate their actions.

Exercise Evaluation

Part of the preparatory work for an exercise is to arrange for its evaluation. This is best done by all the participants (players and controllers) as well as by evaluators specifically appointed for this purpose, and assigned to various areas or activities. Evaluators are given full briefings on the exercise and expected exercise play according to the planned scenario, as well as guidance on evaluating the particular area to which they are assigned. The amount of guidance varies with the knowledge and experience of the evaluator, and can vary from a set of important aspects to watch for to a complete checklist of all items to be evaluated.

A valuable evaluation tool is debriefing sessions in the various centres and among the player groups participating in the exercise immediately upon its conclusion. While these sessions may not produce well-thought out comments, this is more than made up by the many points raised which would perhaps be forgotten by the time the post-exercise reports were written. Additionally, these group reviews often provide valuable insights which individual reports may miss.

Telecommunications

The success of an exercise, as of an emergency management operation, depends to a considerable degree on good telecommunications. For the sake of realism telecommunications means and channels used during the exercise should be the same as would be used during a real operation. This includes the links between the exercise and the control organizations.

In addition, the control organization needs its own internal telecommunications for exercise control purposes. These should, as far as is possible, be independent of the exercise telecommunications, and possess the necessary security.

Documentation

A number of documents have already been mentioned as the product of the planning process described above. Certain additional documents are issued for the information and action of the various participants in the exercise. These include exercise instructions, planning instructions, control instructions, and evaluation instructions. In the case of large-scale exercises it may be necessary to issue a separate administrative instruction.

Logistics and Administration

Depending on the scale of the exercise this could be a major part of exercise preparations. Owing to limitations of space, it is not dealt with further here.

INTERNATIONAL EXERCISES

As mentioned in the introduction to this paper, Ontario has a U.S. nuclear power station very close to its border, and has developed detailed plans to cope with an emergency caused by this reactor. We regularly participate in exercises conducted by the U.S. plant and offsite authorities, and often conduct our own exercises in conjunction with theirs. We thus have some experience of international nuclear exercises, and some comments would be appropriate here.

Special Problems

The main difficulty that arises in holding an exercise of our plans in conjunction with an exercise across the border is that their scenario, developed to meet their exercise objectives, normally does not suit ours. This compels us to develop our own scenario, through we try to use as much of their basic scenario as can be fitted into ours. While this expedient works adequately for exercise activities that are exclusive to our side, it causes problems in those areas where there is interaction between the two sides. The biggest difficulty is faced by our liaison teams in U.S. emergency centres, who find themselves having to operate simultaneously under two different scenarios unfolding. Such teams have to be made part of our exercise control organization, though they continue to act as players in the U.S. exercise.

Special Objectives

Such cross-border exercises enable the adoption of certain exercise objectives in addition to those listed in Table I. The main ones are:

- testing and practising the cross-border notification system
- passage and exchange of data and information between the two countries
- co-ordination of respective actions and measures
- exploring and exposing the impact of actions and measures in one country upon the other

- mutual assistance
- dealing with news media which is linked across the border
- dealing with the impact of media across the border upon our population.

CONCLUSION

The Province of Ontario, which contains most of Canada's nuclear facilities, conducts a major nuclear emergency preparedness program. An important part of this program is the holding of nuclear emergency exercises. Some aspects of this experience, extending over many years, have been discussed in this paper. While recognizing that little or any of our practice would be unique in this field, it is hoped that this account of the way we plan and conduct exercises will be found interesting and useful by other practitioners, and would serve as a constructive contribution to the development of an international nuclear emergency exercise program.

TABLE I
EXERCISE OBJECTIVES

<u>Item</u>	<u>Objective</u>
	Test or demonstrate the adequacy of, and practise:
1. Notification and Alerting	Notification of emergency organization staff, and other affected agencies. Alerting of the public.
2. Emergency Centres	Their setting up and staffing; their layout and equipment; and their organization and operating procedures.
3. Telecommunications	Within and between elements of the emergency organization; backup resources.
4. Accident Assessment	The system for obtaining and evaluating technical data to assess the accident, and project its course and its effects.
5. Decision Making	The system for making operational and protective action decisions, taking into account all relevant factors and criteria.
6. Public Direction	The system for conveying instructions to the affected public regarding protective measures.
7. Emergency Information	The system of providing accurate and timely information on the emergency to the public through the media.
8. Traffic Control	The traffic control plan and its implementation, including entry control.
9. Field Monitoring	The system of radiological monitoring of radioactive emissions.
10. Protective Action	The resources and procedures for the implementation of protective measures, to include some or all of the following: evacuation of the general public and special groups; personal monitoring and decontamination; registration and inquiry; provision of stable iodine; care of evacuees.
11. Emergency Worker Safety	The system for ensuring the safety of emergency workers.
12. Phase 2 Operations	The systems and procedures for dealing with the issues and problems arising in connection with ingestion control and restoration operations.

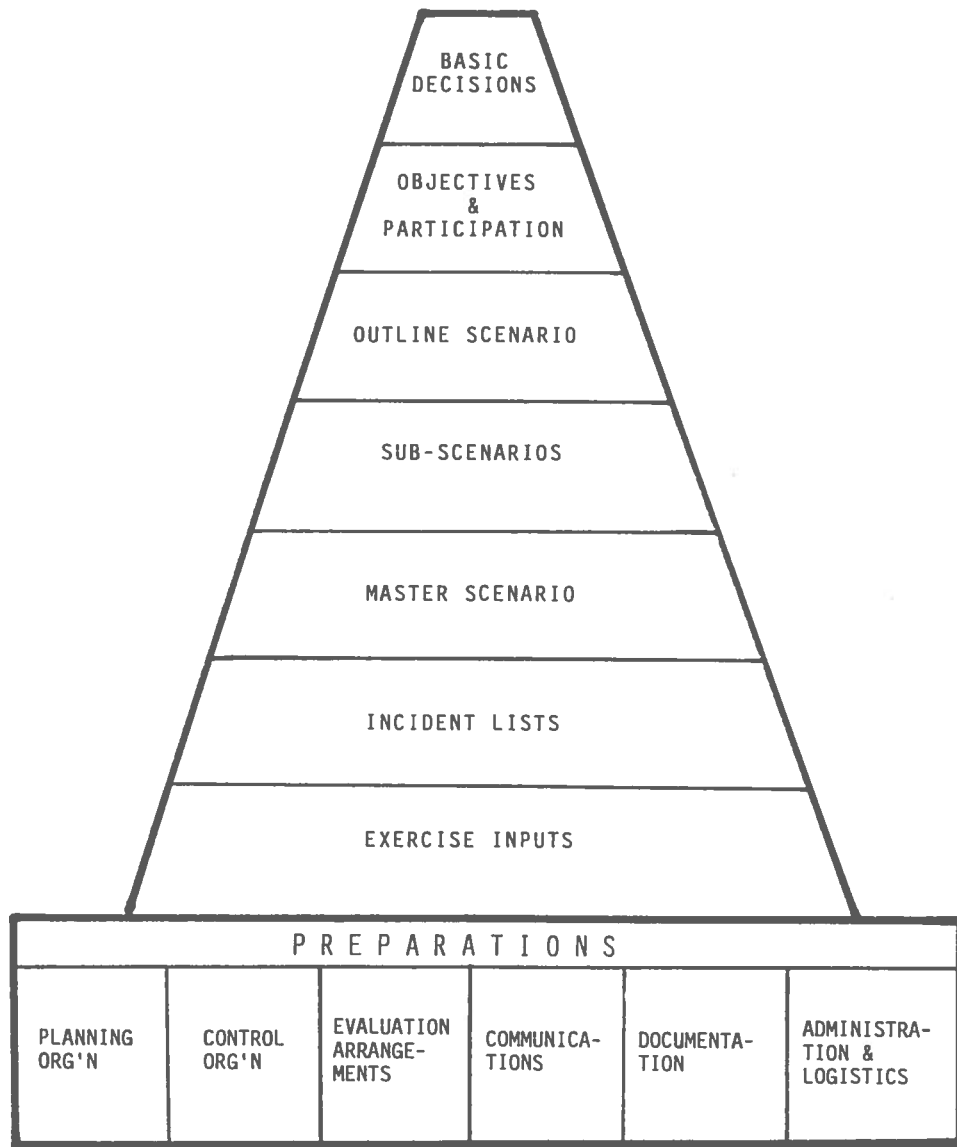

FIGURE 1 - EXERCISE PLANNING & PREPARATIONS

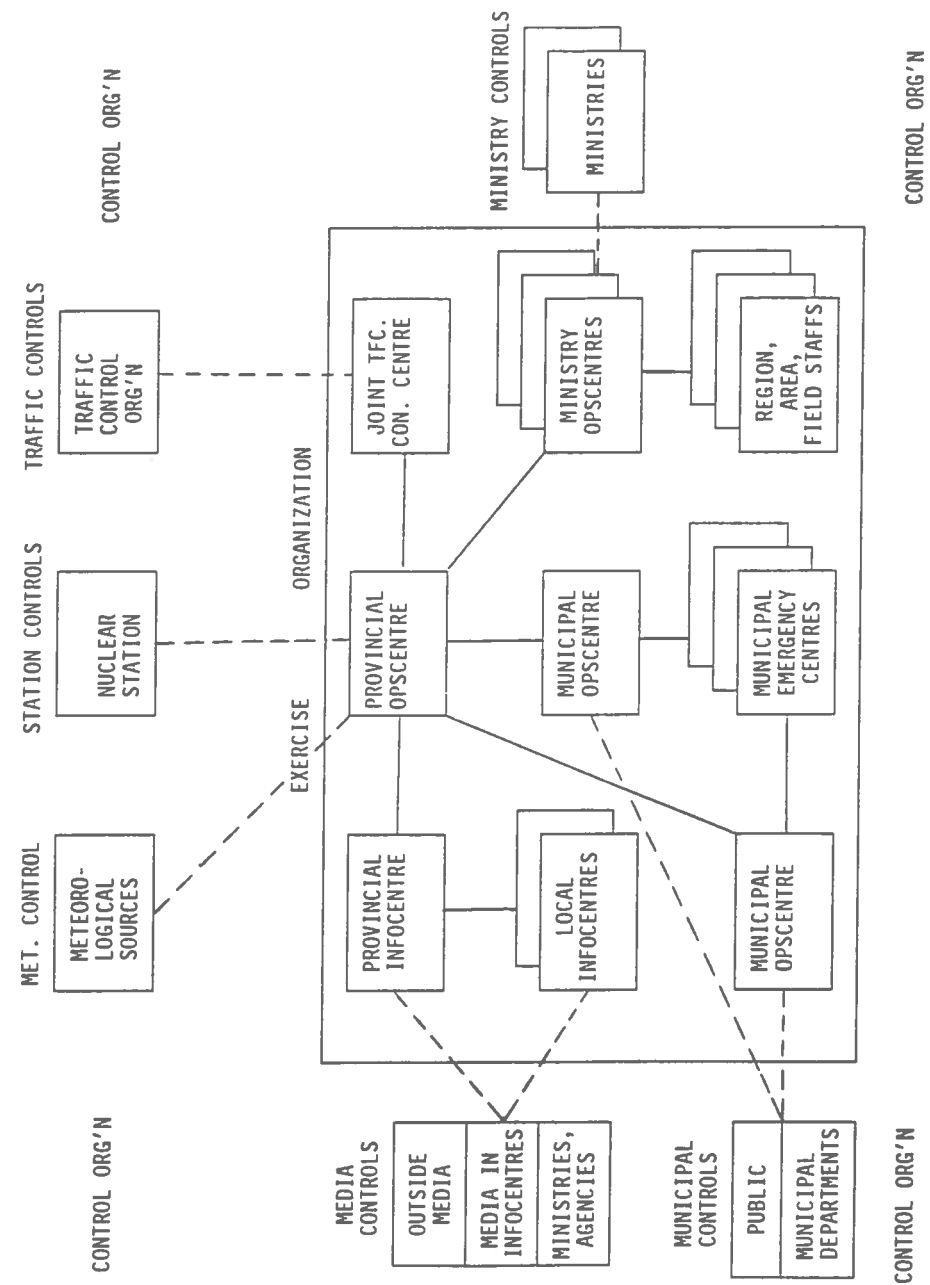

FIGURE 2 - EXERCISE AND CONTROL ORGANIZATION

UK EXPERIENCE IN THE PLANNING AND THE CONDUCT OF EMERGENCY EXERCISES

R D Mehew and A J Lindley
H M Nuclear Installations Inspectorate, Health and Safety Executive, St Peter's House, Bootle,
Merseyside, L20 3LZ, United Kingdom

The views expressed in this paper are those of the authors and do not necessarily represent those of HM Nuclear Installations Inspectorate.

ABSTRACT:

In the United Kingdom (UK) exercises are held regularly to test the arrangements which have been made to deal with an emergency at a nuclear installation. This paper discusses those exercises which concentrate on the off-site nuclear emergency arrangements and involve the operator, emergency services, local and national government and other organisations. A brief review of the off-site nuclear emergency arrangements in the UK is presented. The paper then discusses programming, planning and the setting of aims and objectives for an off-site nuclear emergency exercise. The preparation of the scenario and exercise drivers script is covered and related to the UK concept of reference accidents for emergency plans. Participation and conduct of the exercise is also described, followed by details on evaluation.

1. Introduction

The civil nuclear industry in the UK is over 30 years old and as technical, scientific and engineering fields have seen changes, so the UK's thinking on nuclear emergency arrangements has developed. This paper outlines the legal basis for these arrangements in the UK, together with some of the significant events in their development. The paper then covers the principal features of the arrangements. Having set the scene, the programming, planning, conduct and evaluation of exercises involving off-site arrangements is described in detail.

2. Background

In the UK, operators of all civil nuclear installations are required by the Nuclear Installations Act of 1965, to hold a nuclear site licence to permit them to be built, operated and decommissioned. Civil nuclear installations cover the processes of nuclear fuel manufacture, nuclear reactors, nuclear fuel reprocessing and the processing of radioactive isotopes for commercial, therapeutic and research use. Licenses are granted by the Health and Safety Executive (HSE), of which Her Majesty's Nuclear Installations Inspectorate (NII) forms part. The Nuclear Installations Act enables conditions to be attached to the licence and specifically identifies emergency arrangements as a topic for one of these conditions. The primary function of NII is to enforce the conditions attached to the license at nuclear sites.

The Ionising Radiations Regulations of 1985 (IRRs) which implemented a European Communities Directive, lay down basic safety standards for the protection of the general public and workers against the dangers of ionising radiations. One regulation of the IRRs calls for the making of contingency plans to minimize exposure to ionising radiation resulting from an accident. This regulation, together with the license condition on emergency arrangements, forms the basis of the current UK legal requirement to have arrangements for dealing with nuclear accidents.

An 1957 Windscale accident report [1], led to a review of the site emergency arrangements of the then existing United Kingdom Atomic Energy Authority sites. These improvements were carried over into the UK nuclear power production programme undertaken by the then Central Electricity Generating Board (CEGB) and the South of Scotland Electricity Board (SSEB). (The nuclear power generation part of the CEGB has become Nuclear Electric plc whilst that of SSEB has become Scottish Nuclear Ltd.)

More recently, the 1979 Three Mile Island accident caused a review of UK nuclear emergency arrangements which gave rise to the creation of the post of a Government Technical Adviser (GTA) and the provision of an Off Site Centre (OSC), Media Briefing Centre (MBC) and national response centres [2]. A subsequent review after the 1986 Chernobyl accident led to the conclusion that "the existing (emergency) plans continue to provide a valid basis for the response to any nuclear accident in the UK" [3]. Most recently, the report of the Hinkley Point Public Inquiry which reviewed nuclear emergency arrangements, recommended some further development in the areas of the extendibility of the arrangements and the legal basis of the off-site nuclear emergency arrangements [4].

3. Emergency Arrangements

The UK's nuclear emergency arrangements are based upon a number of centres which are shown in Figure 1. The site emergency control centre is responsible for initiating the response to the emergency which has five principal features:

- (a) control of the accident at the installation;
- (b) assessment of the accident potential and consequences;
- (c) alerting the relevant organisations;
- (d) introduction of countermeasures; and
- (e) the return to normal conditions.

The site emergency control centre is primarily set up to regain control over the accident and, for the first hour or two, undertake assessments, alert organisations and provide advice on countermeasures.

An Off Site Centre (OSC) is set up within a few hours of the declaration of an accident to relieve the site of off-site matters. Its functions are to:

- (a) provide a centre at which local and national organisations can receive information and liaise with the operator in the locality;
- (b) formulate advice to the local emergency services on countermeasures;
- (c) provide information to the media at a nearby Media Briefing Centre (MBC); and in some cases
- (d) mobilise resources to assist the site.

Both local and national organisations would also set up their own emergency control or response centres to aid their response to the emergency. A national response centre is also set up by the lead government department whose function is to:

- (a) provide a centralised information and briefing point for government departments;
- (b) coordinate any national response to the accident which may be required; and
- (c) to meet international reporting commitments.

Annex 1 gives a list of organisations who would respond to a nuclear emergency and their functions. A more comprehensive account has been published [5] which revised the early version [2]. It should be recognised that all of the organisations are essentially independent of each other and thus the compatibility and harmonization of their arrangements is a matter for discussion and agreement. Each organisation has its own arrangements which describe its response to the emergency, often known as an emergency plan.

The principal objective of the off-site response is to implement any necessary early countermeasures to protect the public. In the first few hours before the OSC is operational, the site is responsible for advising the police on which of the countermeasures of evacuation, stable iodine and sheltering, are appropriate to protect members of the public. The police are the lead local organisation for implementing these countermeasures. A detailed emergency planning zone (depz) around the site is identified in the emergency plans of both the operator and the local police and within this zone detailed arrangements are in place to implement such countermeasures as may be required.

The depz, typically extending between 1 to 3.5 km from the site, is derived from a very conservative application of the reference accident for the site. Details of the reference accident, including the source term, for magnox and advanced gas cooled reactors have been published [6]. The possibility of a more serious accident occurring, however unlikely, requires the

provision of outline plans covering areas outside the depz. The Hinkley Point Public Inquiry report recommended that guidance be given to the local organisations on a hypothetical extended release scenario, against which outline emergency plans could be developed outwith the depz. NII have issued a paper [7] which specifies a source term [8] and provides an indication of the response which may be required to this hypothetical scenario.

When the OSC is set up and declared operational, the operator's representative takes over from the site the task of issuing advice on countermeasures. Within about six hours from the start of the emergency, the Government Technical Adviser (GTA) will arrive at the OSC and take over responsibility for providing this advice. The GTA's terms of reference are outlined in Annex 1 under the Department of Energy or Scottish Office, who are responsible for appointing an individual to the post for the duration of the emergency.

4. Off-Site Emergency Exercise Programme

The UK has adopted a three tier programme of exercising nuclear emergency arrangements:

- (a) Level 1 - On-site exercises.
- (b) Level 2 - Exercises involving the OSC.
- (c) Level 3 - Exercises involving the OSC and national response centre.

Often a government Minister will participate in the Level 3 exercise. Additionally, every organisation holds its own drills and exercises, in some cases with the involvement of others.

Normally Level 1 exercises are run independently of Level 2 or 3 exercises. NII has accepted that it is not necessary to exercise all parts of the emergency arrangements at the same time for two reasons. Firstly because such large scale participation would create an unreasonable demand on resources and that certain parts would be excessively exercised if they took part every time. Secondly, because parts of the emergency arrangements can be effectively exercised in isolation, if adequate simulation of the interface with other parts is provided.

Since the programme of Level 2 and 3 exercises started in early 1988, most OSC's have been exercised once every two or three years, whilst the national response centres are exercised once per year. The 19 sites in the UK with OSC's give rise to a programme of about six off-site emergency exercises per year. (The status of two sites is under review following the closure of their operating reactors.) NII coordinates a rolling programme of Level 2 and 3 exercises covering three years. This degree of advanced planning has been necessary to ensure all OSCs are involved in Level 2 exercises and that organisations can participate and avoid clashes with other commitments. For example, some police forces have major events taking place within their area, such as political party annual conferences, which means that they are unable to become involved in a nuclear emergency exercise at the same time. The absence of such a key organisation could significantly reduce the value of the exercise.

5. Planning for Off-Site Emergency Exercises

A coordinating group is set up to oversee the planning of the exercise. A feature of this group is that it is made up of representatives from each organisation who have the authority to speak on behalf of that organisation. Thus the group can present the coordinated views of all organisations involved in the off-site emergency exercise. (Future reference to an exercise will mean an off-site emergency exercise.)

The coordinating group functions are to:

- (a) specify the overall and individual organisations objectives for the exercise;
- (b) identify the participating organisations and centres which will be exercised;
- (c) provide a scenario for the exercise;
- (d) provide an exercise drivers script;
- (e) provide umpires, exercise drivers and make provision for observers and visitors;
- (f) provide a brief for players, observers and others;
- (g) run the exercise under the command of a chief umpire;
- (h) organise an early debriefing meeting for players, observers and umpires; and
- (i) produce a report on the exercise.

At least one sub group is normally set up to undertake the detailed work on the production of the scenario and drivers script. Some operators have set up other sub groups to deal with topics such as media briefing, specification of detailed objectives, production of the exercise report and resolving problems identified by the exercise. The operator provides secretarial services to the group and any sub groups which may be set up. The number of meetings of the coordination group is dependant to some extent on the amount of work delegated to sub groups. Detailed work of the groups is undertaken by correspondence and typically, around five meetings have been found sufficient to cover the exercise planning phase.

6. Aims, Objectives and Extent of the Exercise

By definition, the aim of a Level 2 exercise is to exercise the OSC, whilst the aim of a Level 3 exercise is to also exercise the national response centre. Each organisation specifies its own objectives and the extent to which it wishes to participate. Objectives are expected to be sufficiently specific to allow judgements of effectiveness and adequacy of arrangements to be made by each organisation following the exercise. Detailed objectives must also be set to enable the chief umpire to decide when to finish the exercise.

Organisations may not wish to exercise all parts of their response. As an example, NII will for many Level 2 exercises, fully exercise its own response centre located at the HSE's Bootle headquarters in addition to its functions at the OSC. However it normally simulates the role of the Chief Inspector of NII and only exercises it once or twice per year. Also, the coordinating group needs to identify those organisations which are not participating and therefore provide sufficient simulation to ensure the smooth running of the exercise.

7. Scenario and Exercise Drivers Script

A detailed site based technical scenario is written, primarily by the operator's staff, which forms the basis of the exercise and describes the state of the installation whilst the exercise is running. The description has to be sufficiently detailed enough to satisfy the demands of all organisations and provide for the desired number, type and timing of releases of radioactivity. Source terms are then derived which create the desired off-site consequences.

Typical source terms used in exercises are somewhat larger than the reference accident so as to provide a more challenging exercise. For reactors, source terms of two or three times the size of the reference accident have been used and one occasion the isotopic composition was also varied to make ruthenium the dominant species. Nuclear chemical plant scenarios reflect a wide range of irradiated fuel with differing cooling times and also can involve plutonium. There is a need to ensure that the scenario and the size of the source term are sensible so as to avoid players losing their sense of "reality" in the exercise.

The National Radiological Protection Board has developed, with funding from NII, a computer programme called "EXIGEN" [9]. The programme calculates, from a given theoretical source term, monitoring data at any location which an off-site radiological survey vehicle would measure, if such a release had actually occurred. Monitoring data is given in terms of air concentration, ground deposition, together with their gamma spectroscopy analysis and gamma dose rate at waist height. The principal limitation of the programme is that it can not deal with a variation in the wind direction. The programme has been successfully used in a number of exercises since 1988.

Each organisation may also wish to see specific procedures tested during the exercise. This could cover topics such as dealing with missing persons, house fires in an evacuated area, members of the public requesting reassurance monitoring and media representatives gaining entry to control and response centres, for example. The purpose behind this is to create additional work which an organisation may well have to cope with in the real event, whilst at the same time working towards its principal objectives. The range of topics increases with each exercise and ingenuity of each coordinating group, and, if necessary, the scenario is adapted to take account of such demands. All this detail evolves into the exercise drivers' script which is written in the form of a time table so as to permit the synchronisation of events within the exercise. The script also covers prompts and responses which are required to simulate both non participating organisations and those parts of organisations which are not being exercised.

8. Participation in Exercises

In addition to the players and umpires, each organisation is required to identify its exercise drivers and observers. Obviously, players should not be part of the coordinating group; this can pose problems for some of the smaller organisations with limited numbers of staff. The chief umpire and one or two aides are appointed from the operator's organisation and are located in the OSC. The chief umpire has the authority to input major variations to the scenario or script whilst the exercise is running, so as to ensure that the exercise's objectives are maintained or bring the exercise back into the scenario and script. The technique of stopping the exercise and retraining players in their duties is not used in these exercises.

Sufficient exercise drivers (who are drawn from all participating organisation), are required to feed information to the players from the scenario and script. It has been found advantageous to use drivers who are not known to the players when simulating members of the public, to add to the realism. Observers are nominated by each organisation to be present at each centre where it is represented. Although their objective is to assess the performance of their own organisation's detailed arrangements, they also can monitor the progress of the exercise and advise the umpires when significant deviations are arising.

Visitors are taken care of by the host organisation of the centre. Experience has shown that the number of persons other than players at the OSC has to be controlled to avoid them becoming an unnatural burden on the centre. Some exercise drivers can be located outwith the centre depending on the modes of communication they will be using since, for example, the recipient of a telephone call need not be aware of the actual location of the sender. When the exercise is spread over several centres, umpires and drivers at each centre need to have agreed arrangements for communication so as to ensure that the exercise remains coordinated.

Normally umpires, exercise drivers and observers are involved with the coordinating group or sub groups which minimises briefing requirements. Players and visitors do require a

brief to set the scene prior to the exercise. The brief must also state the exercise authentication signal to avoid other events or persons from accidentally intruding into the exercise. This often takes the form of an exercise name being quoted at the start of each communication. The precaution is also taken of including a special statement in the brief so as to permit the exercise to be terminated if a real emergency arises.

9. The Exercise

The exercise is started using the standard procedures of the site. Systems for alerting staff are often manipulated so as to ensure that the players are specified staff who have received prior notification. This permits exercise experience to be gained by the organisation's staff in an ordered manner and minimise interference with its normal operations. It is not considered wise to allow real time travel by road over long distances and in such cases, the journey is simulated.

To date, most exercises have followed real time from the initiating event on-site and no case has yet been identified to justify starting the exercise some time into the emergency. Normally exercises run for 8 to 12 hours in real time without discontinuities. Several exercises have been run over two or three days, using time steps to avoid running over night but experience to date indicates that time steps are artificial and impose a strain on the realism of the exercise which is difficult to overcome. Few scenarios have been identified which suggest an emergency situation remaining out of control for more than 10 hours, though the return to normality will obviously take days or longer to resolve. It is expected that the most difficult part of a real emergency would be the initial reaction, and that having successfully overcome this some stability would be achieved. Hence UK exercises continue to focus on the early part of the emergency response, including the task of implementing countermeasures.

There have been a few exercises covering the return to normality phase. The limited experience indicates that the range of variables involved in decision making in this phase is vast. It was found difficult to provide a scenario and script to enable the exercise to continue with any degree of realism. One exercise switched from an active exercise mode to a table top mode for this phase. Representatives from each organisation then discussed possible options and information requirements. This limited experience suggested that there was some value in this approach.

The exercise is normally confined to a few centres and tasks such as the movement of materials to the affected site are simulated. The most involved centres are the OSC and MBC and organisations exercise their own centres as they see fit. Reception centres for evacuees been set up on relatively few occasions and in these cases evacuees have been simulated to allow monitoring activities to be tested. It is usually argued that locations such as reception centres and hospitals are exercised on other occasions and during real emergencies, and hence do not always need to participate in the exercise.

The end point of the exercise is decided by the chief umpire in consultation with observers, when they feel that sufficient of the exercise objectives have been met. On occasions, a late demand has arisen and the observers have wished to see it dealt with before terminating the exercise. Some organisations' centres are able to be shut down part way through and be simulated for the rest of the exercise. It is necessary to ensure that an end of exercise message is sent to all centres.

10. Evaluation of the Exercise

The first stage of the evaluation process consists of separate debriefing meetings held privately by each organisation which may last up to two hours. Experience indicates that these should be held as soon as is reasonably practicable after the exercise has finished and that food and drink should be available for the participants. These meetings should then be followed by the main debriefing session which will be attended by representatives of all the participating organisations. These representatives will be able to put forward the experiences and observations of their teams and relay any feedback which has arisen from remote participating centres.

The agenda of the joint debriefing meeting normally consists of:

- (a) Synopsis of the scenario and script;
- (b) Statement of the principal objectives and initial views by the chief umpire;
- (c) Statement of initial views by the operator;
- (d) Statements of initial views by other organisations;
- (e) Summary by the chair person; and
- (f) Reminder of date when written comments should be submitted by.

Each organisation is expected to provide one speaker, with the exception of the operator who may wish to report separately on the performance of the OSC and MBC. Notes of the meeting are taken and form an annex to the final report.

Within a few weeks, all organisations are expected to submit their written comments on the exercise and these will normally form an annex to the final report. In addition to this, a separate set of comments will have been collected within each organisation which cover aspects of the exercise which are of sole concern to that organisation. Such internal comments are left as a matter for the organisation to deal with.

An exercise report is drafted which covers the following topics:

- (a) Summary;
- (b) Introduction;
- (c) Exercise objectives;
- (d) Organisations and centres involved;
- (e) Scenario;
- (f) Review of exercise events;
- (g) Lessons learned;
- (h) Conclusions;
- (i) Recommendations;
- (j) Annex containing organisations' comments;
- (k) Annex containing notes of debriefing meeting;
- (l) Annex(s) containing other significant information.

Agreement on the draft report is obtained from all organisations before the approved version is distributed.

Recommendations involving several organisations together are normally the subject of consultations leading to agreed corrective actions. In its regulatory capacity, NII will monitor progress of those recommendations which are laid upon the operator. In addition, NII keeps a data base of lessons learned from Level 2 and 3 exercises. This information has been circulated widely amongst the major operators, NII and interested government departments. Experience has been transferred in this way and in some cases, working groups have been set up to search for suitable solutions which could be adopted by all operators.

11. Lessons Learned

Experience from over 3 years of planning Level 2 and 3 exercises has taught two significant lessons. The first is that scheduling of exercises needs to be completed one to two years in advance of the date so as to ensure that key organisations do participate. The second lesson is that planning needs to start some six to nine months before the date of the exercise to give sufficient time. A few exercises have managed on less, but generally because the exercises drivers' script has been fairly simple.

12. Conclusions

UK experience in undertaking a coordinated programme of Level 2 and 3 exercises of the off-site nuclear emergency arrangements now covers nearly 4 years. General procedures for the conduct of such exercises are now well defined and cover the principal areas of:

- (a) setting objectives;
- (b) producing a scenario;
- (c) running the exercise; and
- (d) learning lessons from the exercise.

The man power requirements for an exercise are large and the technique of simulation is used to reduce costs to acceptable levels. The number of exercises is sufficient to warrant a three year rolling schedule of exercises which minimises scheduling difficulties.

13. Acknowledgements

The authors wish to thank Miss F E Taylor for her contribution to this paper.

14. References

[1] "Report of the Committee appointed by the Prime Minister to examine The Organisation for Control of health and Safety in the United Kingdom Atomic Energy Authority"; Command Paper 342 of the Houses of Parliament; January 1958.

[2] Health and Safety Executive: "Emergency Plans for Civil Nuclear Installations"; ISBN 0 11 883669 2; 1982. (NB see Reference 15 for revised version.)

[3] "House of Commons, Official Report of Parliamentary Debates"; Hansard Vol. 107 No. 26 Cols. 611 to 612; Thursday 18 December 1986.

[4] "The Hinkley Point Public Inquiries A report by Michael Barnes QC"; Vol 8, Ch. 68, Appendix 1, Item 7 C (10), page 3027 & Item 7 D (17), page 3029; September 1990.

[5] Health and Safety Executive; "Arrangements for responding to nuclear emergencies"; ISBN 0 11 885525 5; 1990.

[6] Gronow W.S: "Radioactive releases from gas cooled reactors"; in "Seminar on radioactive releases and their dispersion in the atmosphere following a hypothetical reactor accident: Riso, Denmark, 22 - 25 April 1980"; Commission of the European Communities, 1-21; 1980.

[7] HM Nuclear Installations Inspectorate: "Outline Emergency Planning for Licensed Nuclear Power Stations"; October 1990.

[8] Hallam J. et al: "A simulation of environmental conditions during a hypothetical accident scenario for the Sizewell B PWR"; National Radiological Protection Board memorandum, NRPB M-118; June 1985.

[9] White I.F: "EXIGEN : Computer simulation of Emergency Monitoring Data"; in "Radiation Protection Theory and Practice, Proceedings of the 25th Anniversary Symposium of the Society for Radiological Protection", 145 - 148; 4 - 9 June 1989.

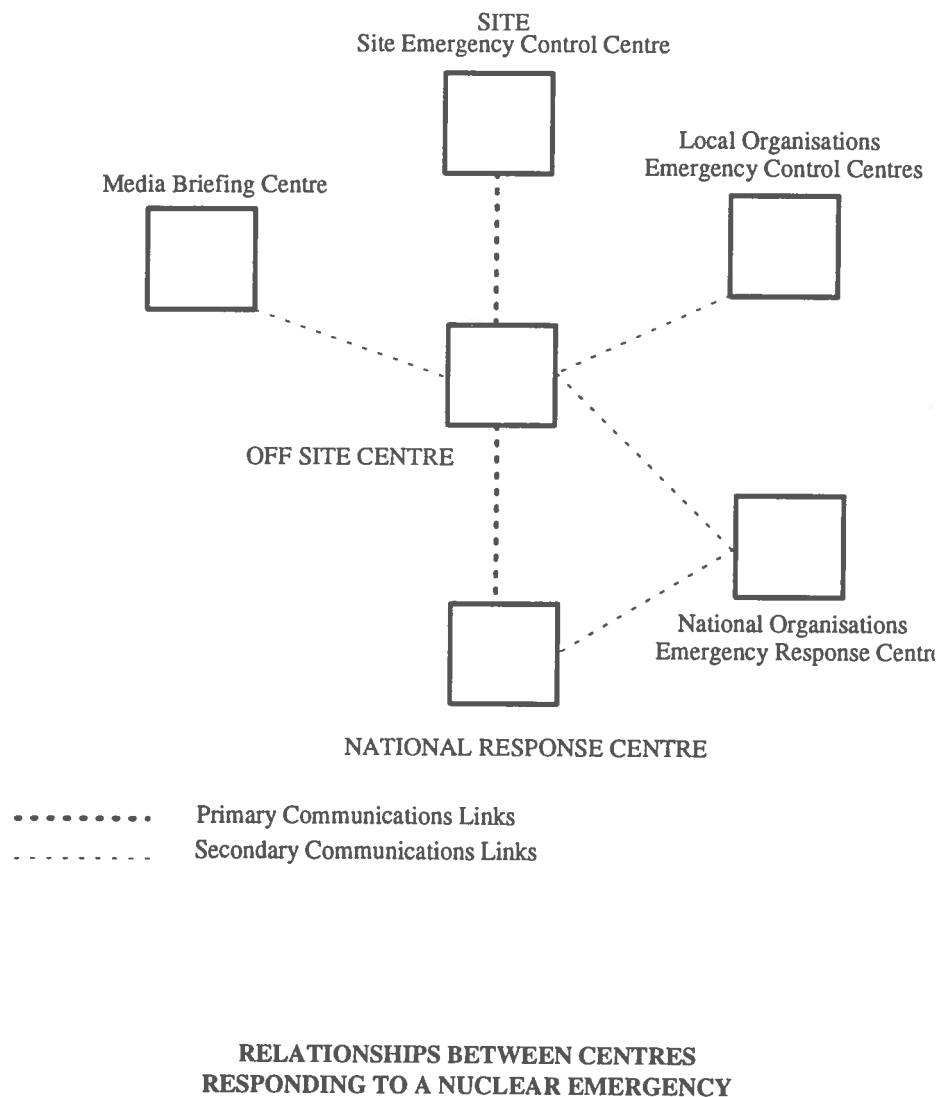

Figure 1

ANNEX 1 : FUNCTIONS OF ORGANISATIONS RESPONDING TO A NUCLEAR EMERGENCY

- (i) Operator of the installation
Restoration of control over the emergency on-site (with the support of the emergency services as required).
Provision of advice on countermeasures and other information as may be required by other organisations.
Provision of information on the on-site response to the emergency.

LOCAL ORGANISATIONS

- (ii) Police Force
Coordination of off-site action to protect and advise individual members of the public.
Implementation of advice on countermeasures.
Control of access to the affected area.
Ensuring the safety of persons and of property.
- (iii) Fire Service
Fire fighting and search and rescue operations at site.
Reacting to fires and other emergencies which occur in affected area.
- (iv) Ambulance Service
Provision of transport for injured persons from site to hospital.
Provision of specialist transport services for the evacuation of sick and disabled members of the public.
- (v) Local Authority or Regional or Islands Councils
Reception and initial sheltering of evacuated members of the public.
Supporting services including feeding, transport, engineering and welfare to evacuees and emergency services.
- (vi) Local Area Health Authority
Provision of hospital services for injured and contaminated persons.
Provision of monitoring services for evacuees and other members of the public.
- (vii) Local Water Company
Implementing advice on contaminated water supplies.
- (viii) National Rivers Authority
Provision of monitoring services and advice on rivers, lakes etc.
- (ix) Her Majesty's Coastguard
Provision of advice on and liaison with sea-borne craft which may be at risk.

NATIONAL ORGANISATIONS

- (x) Department of Energy or Scottish Office
Appointing a GTA, and supporting staff, whose function at the OSC is to:
a) provide independent expert advice on the course of the emergency;
b) review the assessment being made of the course of the emergency, the consequences and the need for countermeasures;
c) act as principal government spokesperson at the Off Site Centre; and
d) advise on the termination of the emergency state.
Provision of national response centre to act as a focal point of information for central government.
Acting as the lead government department in responding to the accident.
- (xii) Ministry of Agriculture Fisheries and Food or Department of Agriculture and Fisheries for Scotland
Monitoring for contamination levels of land and food stuffs.
Controlling the production and supply of contaminated food stuffs.
- (xiii) Department of the Environment or Scottish Development Department
Coordination of monitoring for, and provision of advice on, the contamination of water supplies.
Coordination of UK wide Radioactive Incident Monitoring Network (RIMNET).
Coordination of environmental monitoring.
Provision of advice on the disposal of radioactive waste arising from the accident.
- (xiv) Department of Health or Scottish Home and Health Department
Provision of advice on health implications from exposure to radiation.
- (xv) Welsh Office
Partakes in the provision of advice on and the implementing of, advice on agriculture, water supplies, the environment and health.
- (xvi) H M Nuclear Installations Inspectorate
Monitoring of events on-site and the actions taken to restore plant safety.
To advise central government.
- (xvii) National Radiological Protection Board
Provision of independent assessments of the radiological impact of the accident, including advice on countermeasures.
Coordination of contamination monitoring beyond 40 km from the site.
Provision of support and advice to Local Area Health Authorities on monitoring of members of the public.

EMERGENCY EXERCISE "MOSEL '90"

Horst H. Miska
Ministerium des Innern und für Sport Rheinland-Pfalz
(Ministry of Interior and Sports)
Schillerplatz 3-5

D 6500 Mainz

ABSTRACT

An emergency exercise for the environs of the nuclear power plant CPN de Cattenom was performed from April, 5th to 7th, 1990. Administration and operational personnel from Luxembourg, Saarland, and Rhineland-Palatinate (RP) participated in the combined staff and field exercise; the competent French authority, la préfecture de Metz, played the role of the licensee.

While each responsible authority tested its alarm- and response plan and trained its personnel, a major aim of the off-site exercise was to investigate and improve the methods of communication in this border region location: the outer planning zone (radius 25 km) of the French reactors encompasses parts of Luxembourg and of the two German states mentioned above.

Preparation and scenario of the exercise will be explained and lessons learned will be discussed.

1. Organisation of Disaster Preparedness

In RP, the responsibility for nuclear disaster preparedness rests with the state government which delegates execution to the respective district government. For the CPN de Cattenom, the government of the Trier district is the responsible authority for preparation and - in case of an emergency - execution of the special plans.

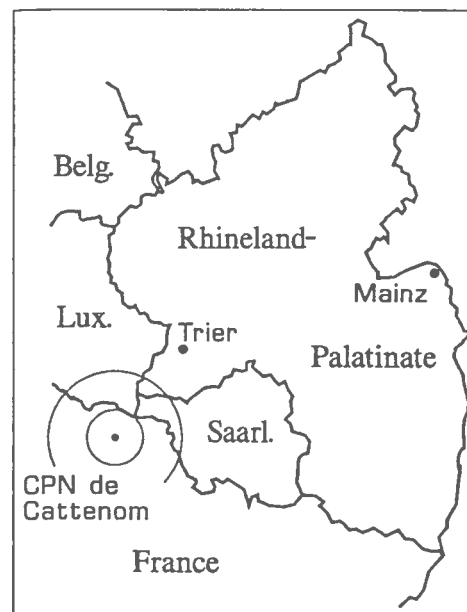

Fig. 1: Location of the nuclear power plant CPN de Cattenom; the outer circle represents the 25 km planning zone.

This master plan of the district government is supplemented by plans of cities and counties dealing with local measures for preventive and remedial actions.

In case of a nuclear emergency, the District Emergency Staff will decide on all measures to be taken. One of its advisors is the Radiation Protection Advisor, backed up by an Advisory Group. He has to evaluate the radiological situation based on the information coming from the plant and from survey teams as well as from the stationary monitoring system. The survey teams, that are also able to take samples, are guided by Survey Headquarters and obtain logistical support from the Monitoring Assembly Point, where they also deliver the samples.

The part of the organisation referring to radiation protection, plant evaluation and monitoring, is shown in figure 2. Altogether, more than ten departments and services work for the staff and, in part, implement actions in their field.

In the case of the CPN de Cattenom, only one county in RP is affected, therefore only one county staff, corresponding to the district staff, and its Technical Command Post is activated. About 3,000 inhabitants live within the outer planning zone in RP (25 km, see fig. 1); support for affected people coming from areas closer to the plant is prepared in RP. In the case of major emissions, at least one Emergency Care Center (ECC) will be set up to monitor affected persons for contamination. Decontamination, medical care, and accommodation, if needed, will be provided by the ECC.

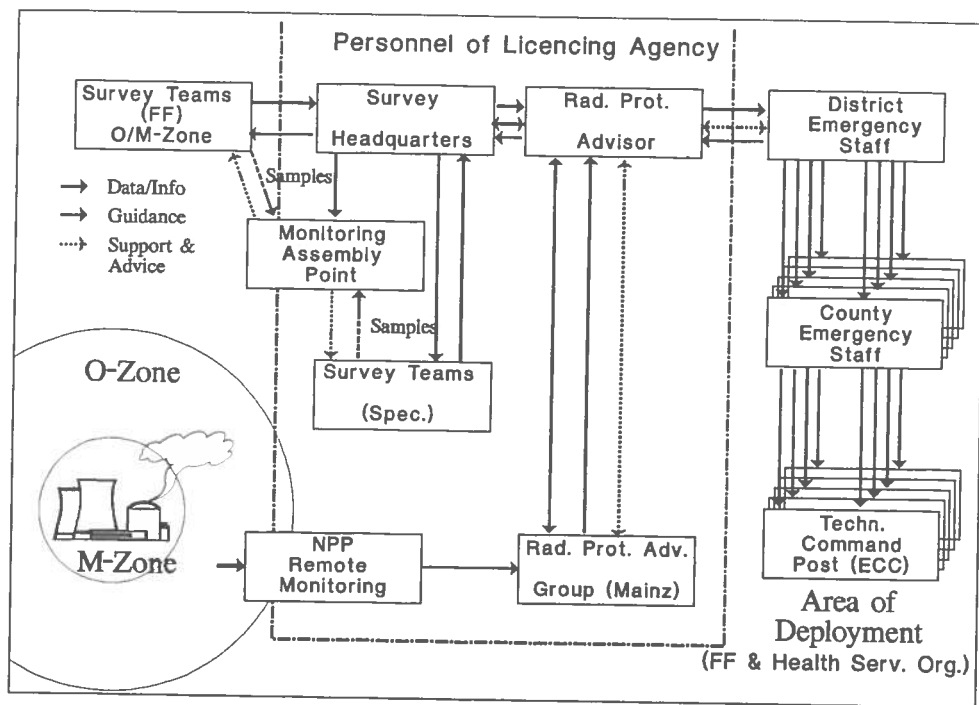

Fig. 2: Organisation of disaster preparedness in Rhineland-Palatinate.

2. Preparation of the exercise "Mosel '90"

To maintain a realistic exercise and to provide learning experience, the scenario was kept from the players and set up by personnel from the state government and other district governments that served as moderators or referees later during the exercise. Place and time of the exercise were made public well in advance to allow for preparations and scheduling. Consequently, the alarm procedures were not tested during that exercise; they are regularly checked by unannounced alarm exercises.

Since this off-site exercise was planned as a combined staff and field exercise, the timing was chosen such that the field part, involving a larger number of volunteers, was run on a Saturday. The initiating event in the plant, "some problems with the primary coolant", was scheduled for Thursday afternoon. From there on, the accident developed with ups and downs to allow for breaks overnight without causing too much exercise artificiality until the climax with a major release of radioactivity from 7:00 to 8:50 hrs on Saturday. Later that day, the Emergency Cooling System was fully operational again to allow for a normal end of the exercise.

The scenario for plant conditions and emissions was prepared by the RP Licencing and Regulatory Agency, the Ministry for Environment (MU), in collaboration with the competent French authority for disaster preparedness, la Préfecture de la Moselle (Metz). Total emissions of $2 \cdot 10^{18}$ Bq of noble gases and $2 \cdot 10^{15}$ Bq of iodines and aerosols each, corresponding to about 20 % resp. 0.02 % of the inventory, were foreseen. During the first days, actual weather had to be used whereas for the last day, weather with winds blowing the plume towards the exercising areas was given as a constraint. These conditions resulted in a projected short term dose (7 days) of about 3 mSv by submersion and inhalation.

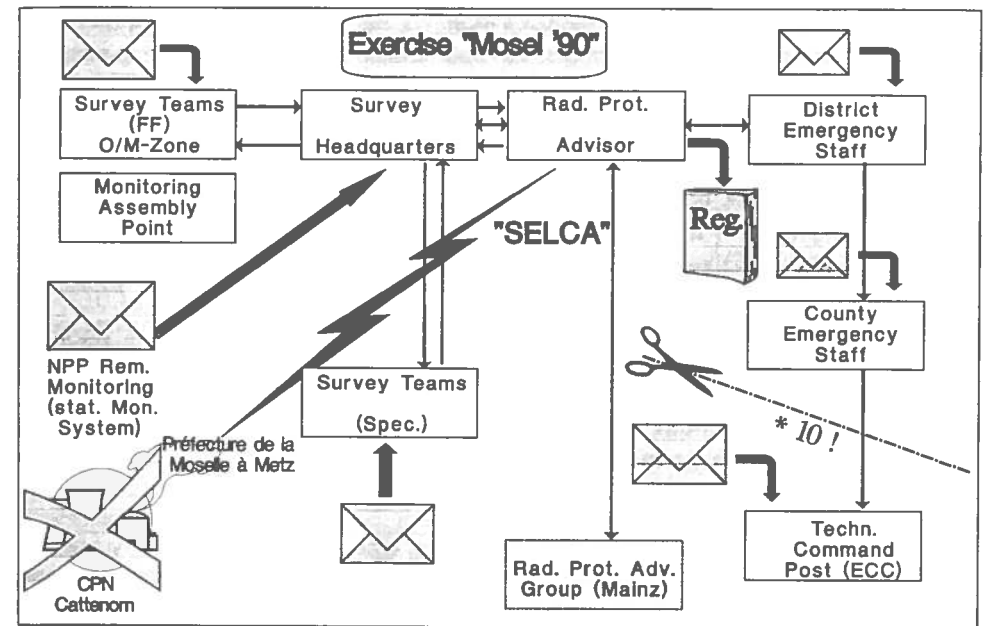

Fig. 3: Staff organisation for the exercise. The envelopes symbolize scenario input; the dash-dotted line the cut in the scenario introducing a factor of ten for the emissions..

Since those expositions did not warrant the set-up of an ECC, the values of the release were magnified by a factor of ten (putting up with the artificiality of 200 % release of noble gases) for that part of the exercise as indicated in fig.3. The radiological situation evaluated by the radiation protection adviser was therefore just registered, while the prepared situation was issued to the staffs and technical command post. Based on the upgraded emissions and on the assumed weather conditions, the radiological parameters were calculated with the code "PLUTO".

Sealed envelopes for survey teams and survey headquarters (here values for the stationary monitoring system) contained time and place dependent assumed values for dose rate and contamination monitor readings. Labels with information for about 100 players, acting as affected citizens seeking help in an ECC, were prepared and gave information on their assumed location at the time of the emission and plume passage. These labels also gave assumed readings for contamination monitoring of these persons.

The scenario included fictitious messages concerning traffic situation, schools, media inquiries and those of concerned citizens and farmers to prompt decisions and actions of district and county emergency staff.

3. Performance of the exercise

Personnel from the state government and other district governments (27 persons) were controlling and refereeing the exercise and served as lead agency while some personnel from the ministry for environment also took part as players. Control was limited to actions to keep the exercise on established tracks and within time frames.

The district government Trier, as the main player, activated its staff and command post supported by personnel from ten departments and central services; liaison personnel to the Bundeswehr (German Armed Forces), county administration, etc completed the staff. The role of the licensee was played by the French authority for disaster preparedness by sending messages concerning the status of the plant on the communication net "SELCA": The county staff was similarly composed. The staffs were responsible for the documentation of their work.

About 25 fire fighters and specialists from the state environmental agency were in the field as survey teams. Players and acting personnel for the ECC were taken from fire fighters (esp. hazmat teams) and health service organisations, altogether about 140 persons, including five physicians.

4. Evaluation and major experiences

Problems developed at the start of the exercise when the departments were still handling their normal business such that the interior phone network was disrupted when personnel moved to other rooms for staff work; also the messenger service showed problems during that phase. Other typical lapses and experiences were:

- messages were not translated (French to German) as planned
- the request for the weather forecast was forgotten (real weather for the beginning!)
- obsolete phone numbers were in the alarm plan and
- as an exercise artificiality, mix-ups of fiction and reality occurred.

Experiences from earlier field exercises made further improvements in this area dispensable, but relating to the equipment and staff work, the following consequences were drawn:

- more phone lines need to be installed, a more effective message service is needed (the average time for a message from author to consignee was about 1½ hrs!); telefax is fine to confirm messages or exchange plots, but ties up lines!
- the personnel of affected departments need better training with respect to radiation protection and nuclear power plant operations, they must at least understand the main facts and units (accomplished afterwards).

- the radiation protection advisor needs more support by an advisory group; contracts have been let to assure back up from exterior specialists in case of a nuclear emergency.
- computer codes for compilation, documentation, and graphic display of data from survey teams and stationary monitoring systems are needed (available meanwhile)
- relevant telephone messages will be confirmed in the future in writing and
- collaboration with neighbouring administrations (country, state, county) must be maintained and improved by more exercises such as "Mosel '90"!

Even though "Mosel 90" was a rather small exercise or for that very reason, it succeeded in testing the collaboration among authorities, interplay within each authority, communication practices, and handling of the media.

EXERCISE SIEVERT

B Åke Persson and Mauritz W Wallin
Swedish Radiation Protection Institute (SSI)
Box 60 204, S-104 04 Stockholm
SWEDEN

Abstract

Large-scale exercises normally start with a sequence alerting the off-site organization and they usually last only over the acute time-phase of the accident. The opportunity to train to handle all those questions which come up some days after an accidental release of radioactive substances has therefore been very limited. To get an opportunity to train the emergency organization to act in a later time-phase, exercise SIEVERT was organized with a scenario starting the exercise two and a half days after the accident had happened.

1 Background

Offsite nationwide emergency planning against nuclear accidents involves a number of authorities and organizations with very different tasks as well as competence and experience related to radiation protection matters. To be trained to act in emergency situations in a co-ordinated way, the personnel from the respective bodies commonly participate in different types of exercises. Some exercises may involve only individual parts of an emergency organization while others involve a major part or the whole organization. Often the scenario of the exercise comprises the initiating alerting of the organization followed by the first acute time-phase with accidental releases of radioactive substances leading to contamination of the nearest surroundings. After this time, or a short time thereafter, the exercise will often finish.

However, when organizing exercises it is important to recognize that the role, tasks and also the importance for the participating bodies in an emergency organization can be expected to vary to a great extent for the various time-phases of an accident. This means that some part of the organization must be prepared and trained to act in the acute time-phase, to some extent more or less automatically using previously stipulated routines. Other parts of the emergency organization play their most important role first some days after a ground contamination has occurred.

In this time perspective there will be a need for decisions regarding not only the protection of the public in the emergency planning zone nearest the plant but also regarding countermeasures outside the zone concerning such matters as farming, food supplies, relocation, tourism, use of contaminated vehicles, appraisal of various measuring values. One common factor is that these decisions ought to be valid for a longer time than the first day or days after the accident has occurred.

When organizing exercises in Sweden this fact has been taken into account when training the emergency organization at the Swedish Radiation Protection Institute (SSI) which is one of the national emergency centres in a nationwide organization. The SSI has an advisory role on radiation protection matters to local and regional emergency centres as well as to other national authorities. This paper describes the scenario and experience from such an exercise. The scenario was such that the exercise started first some days after the contamination of the ground had become a reality.

2 Emergency organization structure

In general terms a nationwide emergency organization can be divided into the following components:

- a management organization
- a field organization
- advisory bodies

The *management organization* includes the local rescue command centres with its staff. In Sweden, all 24 county authorities have the responsibility of setting up such a regional emergency centre for nuclear accidents as well as for other severe accident situations. In the four counties where there are nuclear power stations, the planning is naturally more extensive than in other counties.

The county Governor, who is conducting the regional emergency centre, has the responsibility of deciding upon countermeasures to protect the public, especially in the first short time perspective after an accident has occurred.

The *field organization* comprises all various teams performing measurements as well as the police, fire brigades, coast guards, ambulance services etc. The nationwide Swedish field organization also includes all urban and rural districts with teams trained to perform dose-rate measurements.

In addition to local and regional emergency centres various national emergency centres are organized as *advisory bodies* including different kinds of experts. The Swedish Radiation Protection Institute (SSI) is such a national emergency centre with the role of providing advice regarding radiation protection matters.

SSI National Emergency Center

The Swedish Radiation Protection Institute (SSI) is the competent authority on radiation protection matters in Sweden. SSI has been given the task of setting up a national emergency centre with the role of giving advice regarding radiation protection matters as well as to co-ordinate nationwide monitoring and laboratory resources, if required. The SSI National Emergency Centre also has the role of informing the mass media and the public. The organization of the SSI National Emergency Centre is shown in Figure 1.

An additional important task for the SSI National Emergency Centre is to try to co-ordinate the decisions which are taken by different central authorities. Some of these authorities therefore have representatives present at the SSI National Emergency Centre. Among these authorities are the Swedish Nuclear Power Inspectorate, the Swedish Meteorological and Hydrological Institute, the Swedish Rescue Services Board, the National Food Administration and the National Board of Agriculture. In addition to this, a Scientific Advisory Group consisting of eight highly qualified scientists, can be called upon if needed.

The SSI National Emergency Centre comprises two shifts with about 75 persons engaged in each shift. Of this the Information Department amounts to about 25 persons.

3 Exercise SIEVERT

Generally once a year, the SSI National Emergency Centre participates in a large-scale exercise arranged by the county authority in one of the four counties with nuclear power

stations. Such an exercise normally starts with a sequence alerting the organization. Normally the exercise only comprises the acute phase of the accident. This means that the exercise very much is concentrated on contacts between the nuclear power station concerned and the county authority, discussions on technical matters and the need for acute countermeasures to protect the public such as evacuation, sheltering etc. The opportunity to handle all these questions coming up some days after an accidental release of radioactive substances has therefore been very limited. Reported measuring results have not given adequate training in analyzing the environmental consequences on a more long-time perspective. This can probably be regarded as one of the most important tasks for the SSI National Emergency Centre.

To get an opportunity to train this, exercise SIEVERT was organized with a scenario starting the exercise two and a half days after the accident had occurred.

Objectives

The exercise was mainly designed to train the SSI National Emergency Centre personnel. In summary the objectives of the exercise were to check the ability to

- take decisions and give advice about radiation measurements
- make radiation protection appraisements
- estimate the consequences of the accident even on a long-time perspective
- give advice and information on radiation protection matters and countermeasures to authorities, mass media, the public etc.

Planning

The planning of the exercise started about one year before the exercise took place in December 1990. A project group consisting of nine persons was appointed.

The task for the project group was to write an exercise scenario including detailed timetables for the development of the accident, the environmental consequences and the countermeasures taken during the days before the exercise started as well as for the exercise time-period. What was new was that the scenario and the timetables also had to include the time-period before the exercise started. The exercise then continued for two working days. Appendices 1 and 2 show some part of the above-mentioned timetables.

Some parts of the exercise scenario were more specifically directed to information of the public and mass media and treatment of contaminated and possibly overexposed persons and other medical questions. The latter questions specially related to medical personnel in the SSI National Emergency Centre.

For this reason the project group, in addition to emergency exercise planners and radiation protection experts, also included a physician and an information expert.

Introduction to the exercise scenario

The day before the exercise started the participating personnel were briefed about the accident scenario for the two and a half days before the exercise start. Written material was also distributed including a map (see Figure 1), and the scenario over the news reported in newspaper and other mass media. In summary, the following scenario was given.

Sunday

In the evening, at about 20.00 hours, an accident occurs in a nuclear power station outside Sweden.

At about 23.00 hours a notification, in accordance with the IAEA convention for early notification, reaches Sweden. The SSI National Emergency Centre is called upon. No increased dose rate has so far been detected by the early warning monitoring system.

The weather forecast says that radioactive fallout over Sweden can not be expected before noon on Monday.

Monday

In the early morning hours different national monitoring teams are activated. All urban and rural districts are ordered by the SSI National Emergency Centre to check their instruments for dose rate measurements. Some of the district authorities are also ordered to start to measure the dose rate at predetermined reference places. (This is a procedure which is carried out for training at intervals of seven months).

At 15.00 hours the first increased dose rate value is reported from Gotland, an island on the east coast of Sweden.

Some of the regional emergency centres advise the public to stay indoors and listen to the radio. During the afternoon and evening a large number of dose rate values are reported to the SSI National Emergency Centre from the various monitoring teams.

Tuesday

In the morning, at about 08.00 hours, the SSI National Emergency Centre advise the regional emergency centres in Gotland, Kalmar, Östergötland and Södermanland to decide upon countermeasures and to recommend people to stay indoors and organizing checking of milk and other food supplies such as vegetables, mushrooms etc. Distribution of iodine tablets from national storage is judged not to be necessary.

Wednesday

08.00 hours: With the above-mentioned background, the first shift at the SSI National Emergency Centre started the exercise.

The exercise then continued until Thursday afternoon, with a break during the night between Wednesday and Thursday.

Appendix 2 is an example of the timetable for some of the activities during the exercise.

4 Experience gained and conclusions

The total resources in manpower spent by the SSI on exercise SIEVERT has been estimated to be about 365 mandays. The planning of the exercise took about 200 mandays of this total. In addition approximately 30 mandays were spent by personnel from other authorities on planning and executing an evaluation of the exercise. In total the cost for exercise SIEVERT, which can be assigned to SSI amounted to about 1.2 million SEK.

To this must be added the costs for those central authorities and county authorities who participated in the exercise at their own expense. The order of this cost has been estimated to be about 0.3 million SEK.

As can be seen the planning and execution of an exercise like this can be expected to be rather time-consuming. To some extent this is due to the extensive and very detailed scenario which is a prerequisite for an exercise of this type.

However, exercise SIEVERT very clearly demonstrated all of these difficult problems which must be dealt with by national emergency centres such as SSI in an accident situation with widespread radioactive contamination. In this respect the exercise objective was achieved. The evaluation also led to some changes in the organization structure for the SSI National Emergency Centre.

Furthermore the exercise scenario also has been used as an example how to apply methods to decide upon intervention levels. This work is one part of a co-operation project between the Nordic countries regarding emergency planning.

As a general conclusion it can be said that we have found that it is very well justified also to include this type of exercise in our emergency planning in the future.

Swedish Radiation Protection Institute

National Emergency Centre

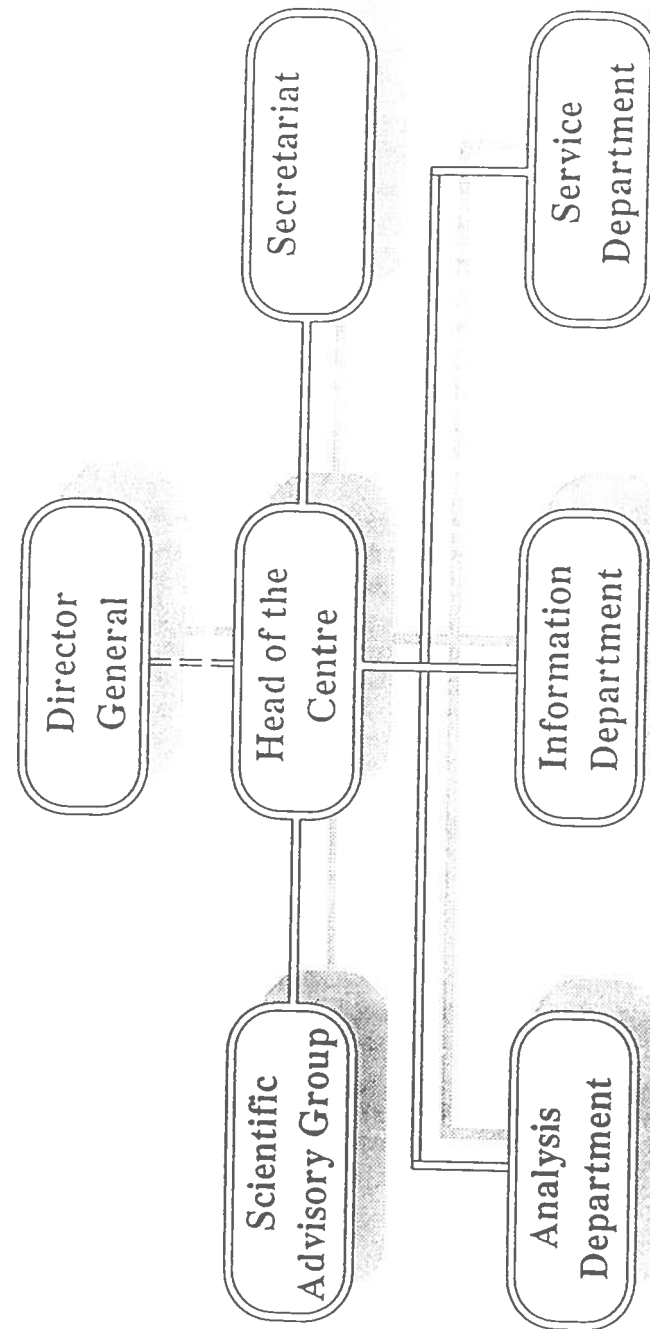

Fig. 1. Organization scheme of the National Emergency Centre at the Swedish Radiation Protection Institute.

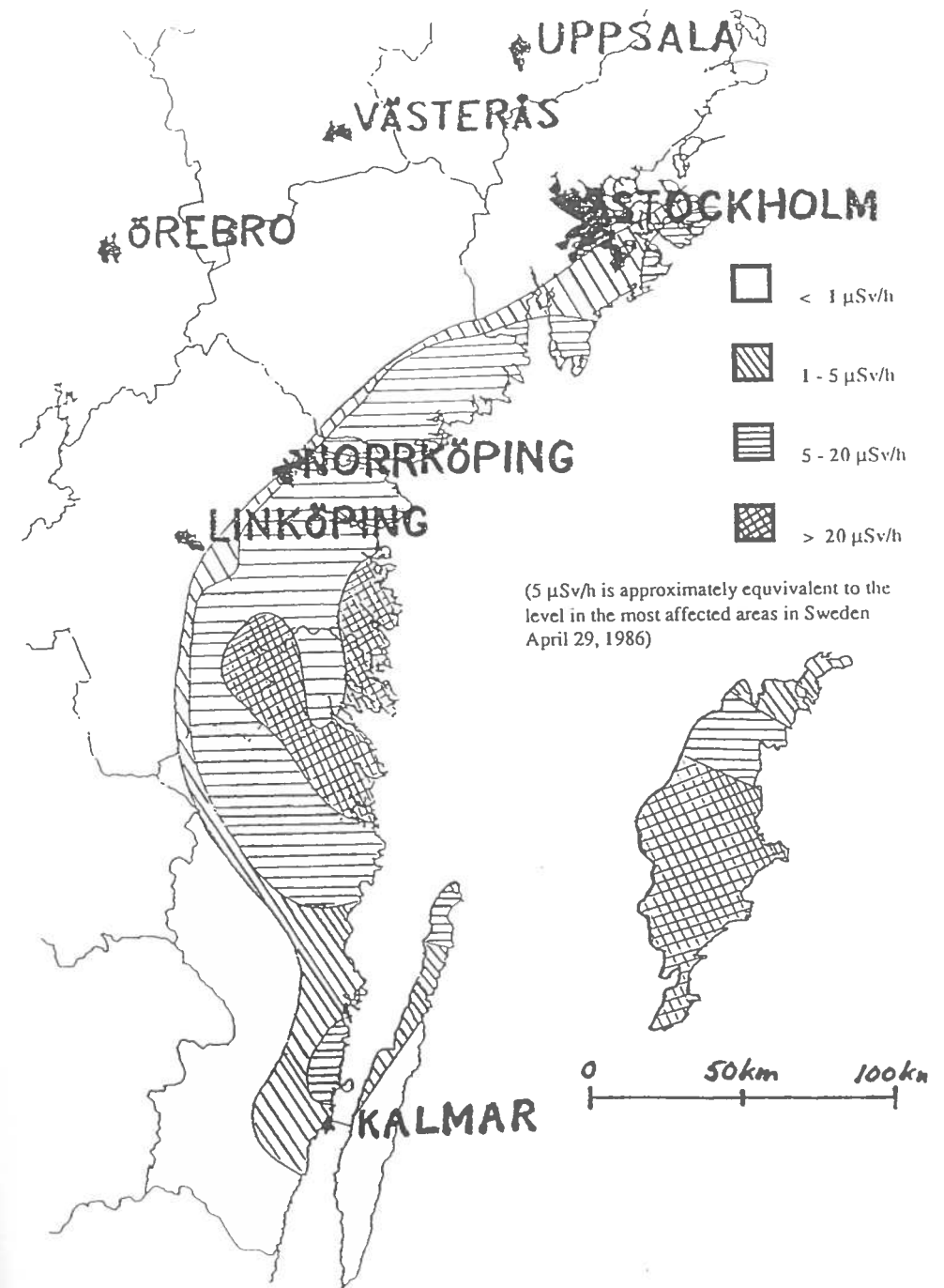

Fig. 2. The fallout situation in Sweden as it was assumed to be when the exercise started.

June 18, Tuesday

- 8.00 - SSI sends the following message to all 24 county authorities: The public in the counties of Gotland, Kalmar, Östergötland and Södermanland are recommended to stay indoors until further notice. The distribution and intake of iodine tablets are not necessary. It is recommended that milk and other food products produced in the counties of Gotland and Kalmar should not be used until further notice. Vegetables, berries and mushrooms must not be consumed. For the remaining counties no special protective measures are recommended.
- A press conference is arranged at SSI.
 - A press release is sent out.
- 12.00 - The analysis of soil samples from the northern part of Öland, taken during the morning hours, shows that large quantities of radioactive material have been deposited on the ground. A great variation in the deposition values is observed, probably depending on variation in the intensity of the rainfall when the radioactive cloud passed by. The highest deposition values that have been measured are 2 MBq/m^2 of I-131 and 375 kBq/m^2 of Cs-137.
- The county authority of Gotland is recommending people from the mainland of Sweden not to travel to the island of Gotland without very good reason.
 - The county of Kalmar is giving the same recommendation to people who have intended to travel to the island of Öland for the midsummer holiday.
 - Measurements of dose rate made by district authorities show pronouncedly increased values in the southern parts of the Stockholm archipelago.
- 14.00 - The results of dose rate measurements and analyses of soil and vegetation samples show that the island of Gotland has obviously been hardly affected by the fallout of radioactivity. But also the northern part of the island of Öland and the coast-belt in the counties of Kalmar, Östergötland, Södermanland and Stockholm have been affected.
- 14.30 - A press release is sent out by SSI.
- 16.00 - Reports from the affected areas reveal great anxiety among the public. Particularly in Gotland people are very anxious. The queues at the airport and at the ferry terminal in Visby are long. All departures are filled. Many people have evacuated spontaneously from the island of Öland. This has caused traffic blocks and casualties on the bridge from Öland.
- 17.00 - A press conference is arranged at SSI.

June 19, Wednesday

- 8.00 - Exercise SIEVERT starts.

App. 1. Extract from the scenario for the first two and a half days after the accident and before the exercise started.

June 19, Wednesday

Time	From	Scenario	Expected measures to be taken
9.00	Swedish Government	The government wants oral and written reports on the consequences of the accident at 17.00 today.	A responsible person is appointed. A report is prepared.
9.05	Ministry of Foreign Affairs	The Ministry wants a background information report in English to send to IAEA and WHO.	A responsible person is appointed. A report is prepared.
9.10	Head Physician at the hospital of Visby, Gotland	Two fishing boats from the Soviet Union have arrived. The crew are anxious in case they are contaminated. How do we handle this?	The Analysis Department is preparing a reply after contact with the Medical Group.
9.10	Ministry of Health	The Ministry wants a report on medical countermeasures to be taken. An oral presentation is requested at 17.00 today.	The Medical Group is preparing a report.
9.20	The Gotland Ferry Line	Our ferry in Visby Harbour is crowded with passengers and cars. Can we leave for Nynäshamn? Should the passengers be checked for radioactive contamination before we leave, or can this be done at the arrival to Nynäshamn?	The emergency organization discusses if there is a need for general advice for ferry traffic.
9.30	Stockholm Harbour	The ferry from Riga in Lettland has just arrived. Can we let people and cars go ashore? The harbour personnel refuses to unship the vehicles and to have anything to do with the passengers. Many passengers are anxious about radioactive contamination, some are complaining about dizziness and indisposition.	The Analysis Department take decision on whether measuring on passengers and vehicles is necessary or not. Perhaps there can be a reference to the general advice in consequence of the inquiry from the Gotland Ferry Line.
9.40	Scandinavian Airlines System	Can we continue with our flights to Eastern Europe and the Soviet Union? What shall we do with the aircraft arriving from these areas?	The emergency organization takes a decision about general advice for air traffic.

App. 2. Extract from the scenario for the two days following the start of the exercise.

NATIONAL STAFF EXERCISE IN THE NETHERLANDS

L.J.W.M. Bergman, A.H. Dal
Ministry of Housing, Physical Planning and the Environment
State Health Inspectorate / Nuclear Energy Section
Leidschendam, The Netherlands

ABSTRACT

In mid 1990, with the implementation of the National Plan for Nuclear Emergency Planning and Response in its' final phase, it was decided to conduct a National Staff Exercise (NSE) on 14 november 1991, focused on an accident at the nuclear power plant in Borssele. In preparing the exercise a workplan was developed and a task force was formed. The task force was responsible for implementing all activities listed in the workplan. Approximately 450 persons participated in the exercise, including an extensive control organization. For evaluation purposes several evaluation reports were drawn up. An international group of experts observed the exercise, visited several participating locations and evaluated the performance of participants. In general the exercise was judged as realistic and successful. Both participants as well as controllers expressed opinions that it was a very instructive exercise and the scenario contained enough elements to perform their tasks as well as provide a realistic assessment of the plan and the procedures.

HISTORY

In mid 1990, with the implementation of the National Plan for Nuclear Emergency Planning and Response in its' final phase, the responsible authorities discussed the need to assess the adequacy of the plan and its' integration with the facility plan and local and provincial plans via the conduct of an extensive exercise. This discussion resulted in a decision to conduct a National Staff Exercise (NSE) on 14 november 1991, focused on an accident at the nuclear power plant in Borssele.

PREPARATION

In January of 1991 a workplan was developed, containing all the activities that had to be carried out in order to prepare for, conduct and evaluate the NSE. Items incorporated in the workplan were the goals and objectives of the exercise, participating organizations, scenario (technical, operational etc.), equipment/facilities/communications, control, evaluation and exercise publicity. This workplan served as the starting point for the group of primary persons responsible for development and conduct of the exercise, consisting of representatives from the Ministry of the Environment and the Ministry of Internal Affairs. This group established responsibilities and a schedule for implementation of the workplan.

One of the first steps in the workplan was to form a task force consisting of experts from (almost) all participating organizations/services/etc. in the exercise. This task force was formed by early February, at which time they met to review the workplan and establish the task force responsibilities and process for implementing all activities listed in the workplan. The end result of task force activities resulted in a global scenario and detailed scenarios (technical and operational) to support the play by all participating organizations. An important activity was integrating and fine tuning the different scenarios; this activity was one of the primary tasks of the Environment and Internal Affairs working group. This working group, with assistance from the task force, was also responsible for providing and establishing the necessary equipment and facilities that were used during the exercise.

GOALS AND OBJECTIVES

The goals and objectives of the exercise were to use, test, evaluate and assess the adequacy of plans and procedures, information exchange, consultation and deliberation between the responsible authorities, and equipment and facilities.

PARTICIPANTS

Approximately 450 persons participated in the exercise:

- 10 ministries, including the decentralized services of the ministries in the province of Zeeland;
- the provincial government of Zeeland;
- 8 municipalities in Zeeland;

- regional fire brigade, police, health services etc.;
- several research institutes and national inspectorates;
- the national meteorological institute;
- the nuclear power plant in Borssele;
- the national contactpoint for international conventions and agreements.

During a short period the minister of the Environment and the minister of Internal Affairs also participated to the exercise.

CONTROL ORGANIZATION

Organizations/services/etc. that did not participate in the exercise were simulated by one or more representatives of those organizations. It was decided, for instance, that police and fire-brigade personnel would not actually operate in the field. It was, however, necessary to provide the participants with information about activities these groups would normally perform such as: evacuation, sheltering, food-control, etc. For this purpose, at almost every exercise location a control group was formed that had to provide the participants with information that had been developed up front and was incorporated in the different scenarios or had to generate ad hoc information as a result of decisions made by the response organization.

To control the conduct of the exercise, game leaders ("referee's") were stationed at the locations that participated. In addition, four key-leaders (one for each primary facility) and one overall-leader were designated to provide centralized command and control of exercise play. The game-leaders were provided the overall-scenario and the scenario for the specific group/organization they were controlling. They were authorised to intervene if a certain group deviated that much from the scenario that the performance of other groups could be detrimentally affected (any intervention, which deviated from the scenario, had to be pre-approved by a key-leader).

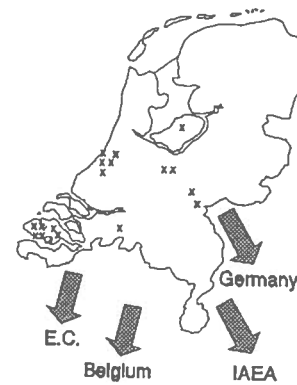

Participating locations and international contacts

The performance of every participating group was assessed by an evaluator. In most areas game leaders also served as evaluators. The evaluators were acquainted with the plans and procedures for the group they were evaluating and could therefore provide good unbiased judgement about the performance of the group.

As much as possible, game-leaders and evaluators were selected from persons who had comparable tasks in an emergency plan for another nuclear facility. For example, the coordinating mayor for the nuclear emergency plan for Doel was the evaluator for the regional management team, while the provincial management team was evaluated by someone from the province Gelderland, in which the Dodewaard nuclear power plant is situated. Both participants as well as controllers found this to be very useful and proposed that this would be continued for all future exercises.

In order to enhance exercise realism, a closed radio-broadcast circuit was installed. Via this circuit, interviews, etc. could be held that could be heard at the same time at almost all participating locations. Two media-experts were hired, they developed news-flashes every hour and conducted interviews as frequently as possible and reasonable.

EVALUATION

Input for the evaluation of the exercise consisted of the reports by the evaluators, feedback from the participants, and feedback from the data-controllers. The remarks were collected in three ways:

1. with a questionnaire that everybody had to fill in;
2. by short de-briefing sessions conducted immediately following the end of the exercise;
3. by personal interviews with key participants after the exercise.

The output consists of evaluation reports for each participating group, evaluation reports for the three governmental levels, evaluation reports for the two public information centers and an executive summary.

International group of observers

An international group of experts was invited to observe the exercise and to evaluate the performance of the players.

Among the group were the director-general of the OECD/NEA and the director-general of direction XI of the European Community.

The group visited the power plant in Borssele, the regional coordination center in Vlissingen, the provincial coordination center in Middelburg and the national coordination center in Den Haag.

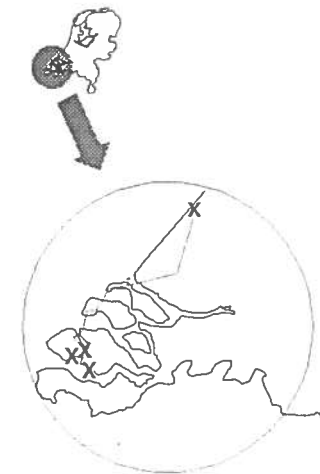

Tour of the international group of observers

RESULTS

In general the exercise was judged as realistic and successful. Both participants, as well as controllers expressed opinions that it was a very instructive exercise and the scenario contained enough elements to perform their tasks as well as provide a realistic assessment of the plan and the procedures.

A major problem during the exercise was information exchange. Persons who had important information about the accident or the consequences transferred this information too late, and in some cases, not at all to other participants. This resulted, particularly for the management teams (decision-makers), in situations that they had to make decisions based on insufficient or incorrect information. In addition, information was not consistent between locations, resulting in different decisions being made at different locations by the responsible management team.

The deliberation/consultation system between the three coordination levels was infrequently used and when used, improperly used.

The collection and evaluation of technical information at technical support centers went well. Translating, informing and advising the management team, based on this information was inadequate.

The public information organization functioned in a passive mode throughout the exercise; for example, the players in the information centers did not collect or seek out information on their own, only reacting on information they received. This was done, however, in an adequate manner.

Preparation of the participants for the exercise was below expectations. Some players did not know or understand their role and function and were not familiar with the plans and procedures for their group/organization.

A final summary conclusion was that the organizational structure, developed and described in the National Plan for Emergency Planning and Response, can be adequately implemented for handling (major) accidents with nuclear facilities.

The participating organizations are symbolised along with the location of their operation in the following figures.



Governmental Coord. Centres

Governmental Coord. Centers

Coordination Centers were established on the national level (Den Haag), provincial level (Middelburg) and regional level (Vlissingen).

Technical Support Centers

Various institutes are responsible for the collection and evaluation of information about the release, the radiological consequences of the release and meteorological data.



Technical Support Centres



Public Information Centres

Public Information Centers

National and regional public information centers were setup and operational.

SESSION III

**PLANNING, CONDUCT AND PRINCIPAL FEATURES, BENEFITS AND
LIMITATIONS OF VARIOUS TYPES OF EXERCISES: TABLE-TOP,
COMMAND-POST AND FIELD EXERCISES**

CHAIRMAN

**J. BOND
(CANADA)**

UNITED STATES EXPERIENCE WITH THE PLANNING, CONDUCT
AND LESSONS LEARNED FROM RADIOLOGICAL EMERGENCY
MANAGEMENT EXERCISES

D. M. Rohrer, Director
Program Performance Assessment Division
Office of Health Physics and Industrial Hygiene
Office of the Deputy Assistant Secretary for Health
U.S. Department of Energy
Washington, D.C. 20585

ABSTRACT

The United States has developed extensive experience in the area of emergency response exercises especially in the decade following the accident at the Three Mile Island Nuclear Power Station. In that decade, accidents at the Chernobyl Nuclear Power Station and the chemical works at Bhopal, India, as well as severe natural incidents such as earthquakes in California and the explosion of Mt. St. Helen's have served to heighten the awareness of the American public to emergency management issues. By sharing our experiences we offer the opportunity to learn from our mistakes and gain from our triumphs.

1. INTRODUCTION

Modern radiological emergency management is not merely the production of an emergency response plan. It is, instead, a thought process that pervades every aspect associated with a radiological facility. This thought process begins with the first considerations of the need for and design of the facility itself. It embodies the basic precepts of the International Commission on Radiological Protection (ICRP) and its recent recommendations, that being, that the operations of the facility must provide greater good to mankind than the deleterious effects of its operations. This thought process continues with the detailed design and construction of the facility and its equipment. Modern emergency management practices dictate that exhaustive analysis be conducted to determine the best processes, chemicals, and equipment for each particular job within the facility, with the purpose of avoiding or limiting the possibilities of an accident and the consequences of the accident if it does, indeed, occur. The process culminates in the development and coordination of detailed emergency response plans and procedures to guide the operations at the facility. Thus, modern emergency management is an exercise in thought and coordination versus the non-deliberate expenditure of manpower and financial resources. Modern emergency management must be flexible enough to address the entire spectrum of accidents that could impact a facility. This includes both the impact of the facility on its outside surroundings and, conversely, the potential impact from accidents taking place outside of a facility on the operations of that facility.

Modern emergency management may be viewed as having three basic support components. First are the Emergency Plans that identify what is expected to be done to respond to an emergency. Second are the Emergency Procedures that identify how that response will be conducted. They provide detailed and specific instructions to the emergency responder on how to perform a specific task. They also guide an emergency responder in the consideration of other actions that may need to be performed but are not necessarily covered by that specific procedure, thereby guiding the responder to other procedures. Third are the Emergency Exercises that identify how well everything works together. It is the emergency exercise program on which we will focus for this workshop.

2. PAST EXPERIENCES WITH EMERGENCY EXERCISES

For the purposes of this workshop, we will define three types of exercises as follows: (1) TABLE TOP EXERCISES; (2) COMMAND POST EXERCISES; and (3) FULL FIELD EXERCISES. We will discuss our past experiences with each of these types of exercises separately. Later in the paper, we will discuss some of the lessons we have learned from all of these exercises combined.

2.1 Table Top Exercises = Policy

Table Top Exercises are exercises that bring together senior level, national policymakers for the express purpose of considering specific aspects of an emergency that have significant transboundary ramifications and, therefore, require international coordination and cooperation to establish mutually acceptable responses. Table Top Exercises serve as the logical starting point to identify issues and practices to be further developed by more complex and resource-intensive exercises. The type and level of contamination

of foodstuffs that will cause their embargo or destruction is an example of a topic that would be appropriate for a Table Top Exercise. The methods for determining the types and levels of contamination are issues stemming from this policy issue, which would more appropriately be considered in Command Post and Full Field Exercises.

Table Top Exercises are generally conducted by having all of the participants together around a single table, thus, its name. Table Top Exercises are characterized by being the shortest, least expensive, having the least amount of actual play, and generally being the most limited of exercises. However, Table Top Exercises, by their very nature, are also the most important type of exercise from the standpoint of the development of top level policy and administrative protocols. This is because the policy issues are, in fact, the purpose of the exercise and "exercise play" is only necessary to the extent needed to support the development of effective policy. Further, the short duration of Table Top Exercises, usually 8 to 48 hours, fosters the attendance of senior level policymakers, which is absolutely necessary for the development of effective inter- and intra-governmental policy.

The United States has for many years used Table Top Exercises as a means of developing guidance and policy on difficult inter- and intra-agency issues. Table Top Exercises are also especially useful as a training platform for newly appointed senior level policymakers and their staffs. With the ever-shrinking budgets and the need to "do more with less," Table Top Exercises offer an extremely cost-effective means of maintaining a desirable level of decision-making capability. The fiscal pressures are also resulting in a subtle change in the use of Table Top Exercises in that they provide a useful platform for the training of more than just senior level policymakers. Subordinate scenarios, which are largely transparent to the senior level officials, are used to focus "thought exercises" by various response groups. Thus, more extensive exercises involving larger numbers of people physically separated from the senior policymakers are possible and are becoming the norm. A further benefit of this change is to expand the interaction between emergency response staffs and senior level policymakers and to allow for more issues to be identified by the free "thought play" during these exercises. Due to the political importance of the senior level officials involved in these exercises, the planning and control of Table Top Exercises must be superb to avoid wasting their valuable time and to encourage their continued participation in future exercises. The exercise planning and control organization will be composed of a few to about ten individuals and will require between 3 and 6 months of planning effort. The number of "players" involved will be a few tens of individuals and the total cost will be a few tens of thousands of U.S. dollars.

2.2 Command Post Exercises = Procedures

Command Post Exercises are exercises that test the interoperability of the various "command posts" or "emergency operations centers." In general, there are normally a number of emergency response facilities that must effectively communicate with one another for the proper command and control of all the various assets that will come together during the response to a significant radiological emergency. The focus of Command Post Exercises is to test communications, protocols, capabilities and procedures. Command Post Exercises are also the primary exercises used to test and correct response procedures involving multi-agency participation below the policy level.

Command Post Exercises are generally conducted with each organization manning their individual emergency response facilities. The conduct of the exercise involves the actual communication of voice, data, and possibly video

between and among the various facilities. Command Post Exercises involve a much larger group of participants than do Table Top Exercises, but the political rank of the "players" is usually lower. By that we mean there are fewer high level policy people and more technical level people to translate policy into procedures and decisions. The duration of Command Post Exercises, usually 1 to 3 days, is somewhat longer than Table Top Exercises and the costs are significantly higher. However, neither the cost nor the duration of Command Post Exercises are nearly as extensive as for Full Field Exercises.

The United States uses Command Post Exercises as a primary means of exercising emergency plans and preparedness. Difficulties experienced in communications have been the single greatest and most pervasive difficulty in all of the emergency response exercises in the United States and in our response to actual events as well. Due to the rapidly changing infra-structure and interfaces of emergency response organizations and the continuing explosive change in the electronics and data processing technologies, Command Post Exercises offer a necessary platform to recurrently test and validate the interoperability of the various communications equipment on a timely and cost-effective basis. The Command Post Exercises also are used to test detailed procedures without having to expend the resources of a Full Field Exercise. Command Post Exercises in general cost a few tens of thousands to a few hundreds of thousands of U.S. dollars and take approximately 6 months to 1 year to plan and develop the exercise scenario and control functions. The exercise planning and control organization will be composed of a few tens of individuals. The number of "players" involved will be a few tens to a few hundreds of individuals.

3. FULL FIELD EXERCISES = Operations

Full Field Exercises are exercises that test the entire structure of emergency preparedness established for a particular facility or activity. Full Field Exercises are extremely expensive and resource intensive since they involve the actual field deployment and 24 hour-per-day operation of significant portions of the various response assets. Full Field Exercises include the activation and manning of emergency response facilities, the initiation and coordination of intranational and international communications and coordination (especially if significant transboundary ramifications are predicted), and the integrated command and control of all the various assets that will respond to the emergency. The significant advantage of the Full Field Exercise is that it provides a reasonable basis upon which a finding may be made of the overall adequacy of the total emergency planning and preparedness program. The significant level of public participation possible during a Full Field Exercise also serves as a means of satisfying the public's need to be reassured.

Full Field Exercises are generally conducted with as close to a full participation by each and every response organization that would, in fact, respond if the actual event were to take place. While a full level of response is not fiscally possible or practicable, the greatest good is derived by the greatest level of "play." The extensive nature of the Full Field Exercises (a few days to a week or more) requires that the greatest advantage be taken of these unique opportunities to test and validate the interworkings and interfaces of the detailed operational aspects of the response. Full Field Exercises offer the only opportunity to test capabilities in an operational environment as close to the one that they may see during an actual incident. In fact, the exercise planning should attempt to test the capabilities and resourcefulness of the response assets to the maximum degree possible.

The United States has already conducted two Full Field Exercises involving commercial nuclear power plants and a third is planned for February 1993. The U.S. Full Field Exercises are conducted approximately every 5 years. Because of galactic complexity of Full Field Exercises and the coordination necessary to conduct them, the planning and control activities will take 2 to 3 years. The number of persons involved in the planning and control would be a few hundred individuals. The number of "players" will be a few thousands to a few tens of thousands of individuals. The total cost will be many hundreds of thousands to a few millions of U.S. dollars.

4. EXAMPLE LESSONS LEARNED FROM EXERCISES

4.1 Management Aspects of Exercises

Management attention and direct support of the planning of an exercise is the single most important aspect affecting the success of the exercise. All too often inadequate management attention and support will doom an otherwise good exercise to failure.

The success of an exercise is also absolutely dependent upon the desire of the most senior policymakers "playing" in the exercise for it to succeed. Thus, if the players view the exercise as a game it will, in fact, become merely a game. If it is viewed as a learning experience, it will be just that. Therefore, a proper mental attitude must be fostered to support effective exercises.

The amount of "raw" or detailed data provided to management to support their decision-making process must be closely controlled. Raw, inconsistent, conflicting and incomplete data, which is typical of an emergency, can be very disruptive to the decision-making process. Decisionmakers must be provided with information assembled by knowledgeable experts who can offer a perspective on the inconsistencies and inadequacies of available data and the relative usefulness and meaning of those data for decision-making. This is especially true in consequence assessment data.

A normal tendency in exercises is to focus on the past, that is, what has already happened. Unfortunately, such a focus does little good as most of us do not have time machines to change the past. Instead, we must focus on the future. Effective emergency management requires a proactive versus reactive focus, predicting the next decision point and acquiring the necessary data to support well-informed decisions.

A significant deficiency constantly repeated in exercises is the desire of managers to "micro manage" rather than delegate "less important" tasks to their subordinate staffs. By so doing, the emergency managers may become overwhelmed by the complexity of the data being gathered and by the pressure of events surrounding them. This may result in their becoming literally mesmerized by the exercise events and lead to a lack of timely decision-making just at the point where it is most necessary.

All too often senior policymakers and corporate officials become "emergency managers" because of their normal position within their respective organizations rather than because of any specific training and qualifications to enable them to effectively perform the duties and responsibilities of an emergency manager. This is unfair to both the managers and the public because highly trained and qualified emergency managers are necessary to avoid the potentially disastrous consequences of inaccurate or inappropriate responses to a significant emergency.

Oftentimes, radiological emergency response managers give inadequate attention to nonradiological hazards. For example, the adverse consequences of a major hazardous material incident on the operations of a nuclear facility are often completely underestimated. Further, the probability of a significant hazardous material incident far exceeds that of a significant radiological incident. Unfortunately, many radiological emergency managers have not been provided with adequate hazardous material training, thus contributing to an overall insensitivity to these issues.

Finally, emergency managers tend to focus on technical versus people issues. The technology involved in a significant radiological incident can be very demanding, however, the very purpose of the emergency management is to assure that the impacts on people are kept to the minimum degree possible. In order to effectively accomplish this, emergency response managers must maintain an adequate focus on the needs for actions affecting people and the full range of consequences of those actions. Thus, emergency managers must remain aware that a decision to evacuate a population requires a tremendous level of cooperation with public officials and the availability of extensive resources to carry out that evacuation, including a place to which the evacuated population may be taken.

4.2 Exercise Planning and Scenario Development

The financial resources, staff resources, and time expended for the conduct of emergency exercise planning and scenario development will be, by far, the best expenditures of the exercise. Inadequate planning will invariably lead to an inadequate and unsuccessful exercise. Effective quantities of time and resources are necessary to support effective planning. This particular area is also not amenable to increased productivity merely by increasing the size of the planning staff. Time is necessary for effective planning, in addition to an adequately-sized planning staff.

It is of paramount importance in the planning process to establish very early on the detailed objectives of the exercise. It is the establishment of a realistic set of objectives that will dictate the selection of the participants for the exercise and the level of detail of the scenario.

Exercise scenarios must be as realistic as possible to avoid the "players" dismissing the exercise as a game. The realistic nature of the scenario is required regardless of whether the activities under consideration are true and real events or simulations of events. While simulation should be held to a minimum to foster an enhanced feeling of reality on the part of the "players," there are certain situations for which simulation is the only acceptable alternative. For example, the actual manipulation of an operating power plant's controls should never be performed as part of an exercise.

Unfortunately, all too often inadequate time is available for exercises. The tendency is to compensate for this inadequacy by the use of "time compression." To the degree possible, time compression should be avoided.

A significant recurring deficiency in exercise planning and scenario development is the overuse of predetermined or "canned" weather information. While the need for such information, especially wind direction and speed, may be necessary to force the involvement of certain geographical areas and towns in an exercise, its overuse must be avoided.

Without exception, all emergency exercise planning must incorporate adequate attention to safety considerations for all persons involved. Therefore, safety must be planned into the exercise. It is strongly suggested that the exercise planning organization include safety professionals in each of the fields impacting the exercise.

An all too often, underplanned aspect of exercises is the logistical planning area. Provisions for adequate lodging, transportation, food services, medical attention, and other normal support functions are essential to support an effective exercise.

Finally, public and press awareness must be planned into the exercise. This should include specific provisions for press and public involvement prior to the conduct of the exercise to avoid misunderstanding of exercise events. Thus, the public should be aware of where and when the exercise will be conducted. Further, public institutions, especially public officials, must be adequately knowledgeable of the scenario to intercept and correct misunderstandings of the various exercise events.

4.3 Exercise Control and Evaluation

The control and evaluation organizations associated with exercises must be as transparent to the "players" as possible. These organizations must be large enough to perform their responsibilities effectively but not so large as to become burdensome on the conduct of the exercise.

Each member of the control and evaluation organization must be fully knowledgeable of his/her duties, responsibilities, and limits of authority. Further, they must be adequately trained and technically knowledgeable to enable them to effectively perform their duties. It is highly preferable that the controllers are, in fact, more technically knowledgeable than the "players." It is also preferable that controllers have previous experience in practical observation of exercises to assure they act as controllers rather than tourists.

Controllers and evaluators must ensure that they themselves provide no "coaching," "sensationalism," or interference with the actions and activities of the "players." "Players" will often watch the actions and movements of controllers and evaluators to get a hint of upcoming events in the exercise. Thus, controllers and evaluators must exercise care in their actions to avoid providing implicit directions to the "players." The control and evaluation organizations must have adequate contingency plans to keep the exercise play going regardless of real events that take place which may tend to divert the exercise from its established time line and direction.

The control organization must ensure that no significant deviations from the preplanned scenario are allowed without coordination among the various controllers. To ensure absolute control, there should be one single senior controller with final authority for the activities of the exercise.

To enhance control of the exercise, the control and evaluation staff should be provided their own separate communications system to allow them to privately discuss the status, timing, and potential changes to the exercise scenario during exercise play.

Finally, without exception, detailed evaluation criteria must be developed and documented to provide adequate guidance to the control and

evaluation staff and to ensure that findings and observations are not arbitrary and capricious.

4.4 Actual Conduct of Exercises

As indicated earlier in this paper, communications will be the single greatest difficulty in the conduct of an exercise. This area includes problems with languages and use of terms, accents, communications equipment malfunctions, and equipment interoperability or compatibility problems. It is highly recommended that an international language of emergency management be accepted as has been done for air traffic control.

A significant difficulty with exercises is the fact that the normal communications systems are available and useable. However, this will not be true during an emergency. The public use of available communications systems during an emergency will overload those systems within the first few minutes or hours of an emergency. Therefore, exercises should be conducted with limited dependence upon normal communications systems.

To avoid possible public panic during an exercise, voice-privacy encoded radio equipment should be used to the maximum degree possible. Such equipment is also necessary for the control and evaluation organizations.

The purpose of exercises is to identify deficiencies, therefore, no one involved in an exercise should be adverse to finding problems and to voicing them. Also, exercises must be conducted during conditions that will effectively test and, in fact, stress the provisions of emergency preparedness. For example, exercises should involve multi-shift operations to test people, and night and bad weather operations to test both people and equipment.

To avoid misunderstandings and potential public panic, all exercise message traffic should begin and end with a reminder that the message is part of an exercise only and does not reflect a true event.

As previously discussed in the exercise planning section, adequate provisions must be made for adequate logistical support for the conduct of the exercise. Depending on the type of exercise, logistical support will constitute the vast amount of the total costs of the exercise. It includes the buildings and areas where the exercise will be conducted, utilities, and personal needs such as food, lodging, transportation, and medical support.

Of paramount importance during the conduct of an exercise is the health and safety of all persons involved. Therefore, exercise activities must provide for adequate safety equipment, and no actions should be performed that would put personnel into a threatening condition.

It is often necessary to segregate "player" versus "non-player" personnel as well as organizations during an exercise. This is necessary because play is generally being conducted at operating facilities and all participants must be fully aware of what is play and what is real. Further, it is highly desirable to establish some form of highly visible marking system for the various participants in the exercise process.

It is highly preferable to conduct the simulated plant operations from a Computer-based Simulator where an entire operating control room shift may be exercised as a unit without adversely impacting on the actual operations of a facility.

Interface with the media is a tremendous problem during both exercises and real events. The media must be provided adequate and accurate information in a timely manner to avoid sensationalism, rumor, and just plain lies. A professionally trained spokesperson is highly desirable and their importance cannot be overestimated. It is highly desirable to interface with the media early in the exercise planning process as well as during the conduct of an exercise. The greater the knowledge of the media, the more accurately they may reflect the exercise and, hopefully, encourage public acceptance.

An especially difficult area during an exercise or during a real event is the concept of consequence assessment and protective action decision-making. A significant problem is the over reliance and unrealistic expectations of computer-based consequence assessments. The majority of computer-based tools are only intended to provide general information on where to look for contamination and a relative assessment of what level of contamination to look for. Computer-based assessment tools are no substitute for trained and qualified technical staff to assess the situation and offer guidance to the decisionmaker.

4.5 Documentation and Exercise Followup

As mentioned earlier, exercise critiques and after-action reports are only as good as the willingness of individuals to identify deficiencies without embarrassment. Only when a deficiency is identified can we begin to correct it. Great care must be used during exercises to ensure that all participants fully recognize their obligation to accurately identify deficiencies without fear of retribution.

The preparation of a comprehensive and fully-detailed after-action report is necessary to institutionalize the corrective action process and to provide a documented basis for the tracking of corrective actions to their successful conclusion. The after-action report should include root cause analysis to ensure that proposed corrective actions fix the cause of a problem rather than merely its symptoms.

The after-action reports serve as a basis for the trending of deficiencies for a particular facility and for the planning of future exercises that may focus on selected corrective actions to insure that the root problem was, indeed, fixed. They also serve as input to the development of improvements to emergency plans and implementing procedures.

CONCLUSION

An emergency management exercise is the premier method for the evaluation of the overall adequacy of emergency planning and preparedness. While exercises inherently have their limitations, they offer an ability to learn by action for which there is no acceptable substitution. The only other substitution is the response to an actual emergency, which should not be considered acceptable as the primary learning experience. Emergency management exercises also lead to the enhancement of emergency plans and procedures and the coordination and cooperation gained during exercises greatly enhances the real response capabilities to actual events whether they be radiological or nonradiological.

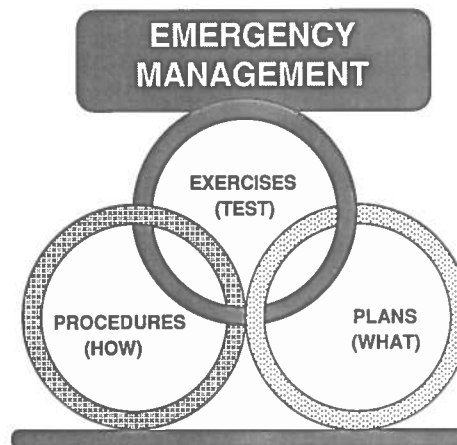

THREE TYPES OF EXERCISES

- TABLE TOP
- COMMAND POST
- FULL FIELD



OFFICE OF HEALTH

TABLE TOP EXERCISES = POLICY

- **PURPOSE:**
ADDRESS POLICY AND DECISION-MAKING ON ISSUES OF NATIONAL AND INTERNATIONAL INTEREST
- **CHARACTERISTICS:**
PARTICIPANTS SEATED IN CONFERENCE ROOM AND INTERACT IN SEMINAR-TYPE ENVIRONMENT - DURATION IS 8 TO 48 HOURS
- **LOGISTICS:**
 - PREPARATIONS 3 - 10 PERSONS FOR 3 - 6 MONTHS
 - PLAYERS TENS OF PERSONS
 - COSTS \$ TENS OF THOUSANDS

PROGRAM PERFORMANCE
ASSESSMENT DIVISION

DATE: 09/11/99



OFFICE OF HEALTH

FULL FIELD EXERCISES = OPERATIONS

- **PURPOSE:**
TEST THE OVERALL, INTEGRATED CAPABILITY FOR RESPONSE TO AN EMERGENCY AT A PARTICULAR FACILITY
- **CHARACTERISTICS:**
FULL PARTICIPATION (AS FEASIBLE) AND FIELD DEPLOYMENT BY EACH AND EVERY ORGANIZATION THAT WOULD RESPOND TO AN ACTUAL EMERGENCY - DURATION IS DAYS TO A WEEK @ 24 HOURS-PER-DAY
- **LOGISTICS:**
 - PREPARATIONS HUNDREDS OF PERSONS FOR 2 - 3 YEARS
 - PLAYERS THOUSANDS TO TENS OF THOUSANDS
 - COSTS \$ MILLIONS

PROGRAM PERFORMANCE
ASSESSMENT DIVISION

DATE: 09/11/99



OFFICE OF HEALTH

COMMAND POST EXERCISES = PROCEDURES

- **PURPOSE:**
TEST COMMUNICATIONS, OPERATIONS, AND INTERFACES AMONG ORGANIZATIONS AT THE VARIOUS EMERGENCY RESPONSE CENTERS
- **CHARACTERISTICS:**
PARTICIPANTS LOCATED AT RESPECTIVE CENTERS AND PERFORM ACTUAL RESPONSE FUNCTIONS - DURATION IS 1 TO 3 DAYS
- **LOGISTICS:**
 - PREPARATIONS TENS OF PERSONS FOR 6 - 12 MONTHS
 - PLAYERS TENS TO HUNDREDS OF PERSONS
 - COSTS \$ TENS TO HUNDREDS OF THOUSANDS

PROGRAM PERFORMANCE
ASSESSMENT DIVISION

DATE: 09/11/99



OFFICE OF HEALTH

EXAMPLE LESSONS LEARNED

- MANAGEMENT ASPECTS OF EXERCISES
- EXERCISE PLANNING & SCENARIO DEVELOPMENT
- EXERCISE CONTROL & EVALUATION
- CONDUCT OF EXERCISES
- DOCUMENTATION & EXERCISE FOLLOWUP

PROGRAM PERFORMANCE
ASSESSMENT DIVISION

DATE: 09/11/99



OFFICE OF HEALTH

MANAGEMENT ASPECTS OF EXERCISES

- MANAGEMENT ATTENTION AND SUPPORT IN PLANNING
- MANAGEMENT INVOLVEMENT AS "PLAYERS"
- QUALITY OF INFORMATION PROVIDED DECISION-MAKERS
- PROACTIVE VERSUS REACTIVE FOCUS
- DELEGATION BY MANAGERS
- QUALIFICATIONS OF "EMERGENCY MANAGERS"
- NONRADIOLOGICAL HAZARDS
- PEOPLE VERSUS TECHNICAL ISSUES

PROGRAM PERFORMANCE
ASSESSMENT DIVISION

DATE: 09/11/04



OFFICE OF HEALTH

EXERCISE CONTROL AND EVALUATION

- TRANSPARENCY OF CONTROLLERS/EVALUATORS
- QUALITY OF CONTROLLERS
- CONTROLLER/EVALUATOR PERFORMANCE
- DEVIATIONS FROM SCENARIO
- COMMUNICATIONS FOR CONTROLLERS/EVALUATORS
- EVALUATION CRITERIA

PROGRAM PERFORMANCE
ASSESSMENT DIVISION

DATE: 09/11/04



OFFICE OF HEALTH

EXERCISE PLANNING AND SCENARIO DEVELOPMENT

- QUALITY PLANNING IS ESSENTIAL
- IMPORTANCE OF OBJECTIVES
- REALISM OF SCENARIOS
- TIME COMPRESSION OF SCENARIO
- "CANNED" WEATHER INFORMATION
- SAFETY CONSIDERATIONS
- LOGISTICS PLANNING
- PUBLIC AND MEDIA CONSIDERATIONS

PROGRAM PERFORMANCE
ASSESSMENT DIVISION

DATE: 09/11/04



OFFICE OF HEALTH

CONDUCT OF EXERCISES

- COMMUNICATIONS PROBLEMS
- ALTERNATE COMMUNICATION SYSTEMS
- VOICE PRIVACY RADIO EQUIPMENT
- IDENTIFICATION OF EXERCISE DEFICIENCIES
- "EXERCISE" IDENTIFIED IN COMMUNICATIONS
- LOGISTICAL SUPPORT
- PERSONNEL HEALTH AND SAFETY
- "PLAYERS" VERSUS "NON-PLAYERS"
- MEDIA INTERFACE
- ASSESSMENT AND DECISION-MAKING

PROGRAM PERFORMANCE
ASSESSMENT DIVISION

DATE: 09/11/04



DOCUMENTATION AND EXERCISE FOLLOWUP

- CRITIQUE PROCESS AND REPORT
- CORRECTION OF DEFICIENCY ROOT CAUSE
- TRENDING AND FUTURE EXERCISES

PROGRAM PERFORMANCE
ASSESSMENT DIVISION



SUMMARY

EMERGENCY EXERCISES

- METHOD TO EVALUATE ADEQUACY OF EMERGENCY MANAGEMENT
- FEEDBACK TO IMPROVE PLANS AND PROCEDURES
- ENHANCE RESPONSE CAPABILITY FOR VARIED ACTUAL EMERGENCY EVENTS

PROGRAM PERFORMANCE
ASSESSMENT DIVISION

Lessons drawn in matters of preparation, conduct and planning of "off-site" nuclear security exercises on basis of three drills recently performed in France

by Paul GINOT

IPSN Delegate, Technical Adviser to the General Secretariat of the
Interministerial Committee on Nuclear Security

Résumé -

La plupart des exercices de sécurité nucléaire exécutés jusqu'à maintenant ont donné la priorité à la phase accidentelle concernant l'installation et les mesures réflexes de protection de la population pendant les premières heures. La phase post-accidentelle au cours de laquelle il faut déterminer les zones contaminées et gérer les rouages de la vie économique et sociale perturbée a été peu abordée dans les exercices.

Trois exercices exécutés récemment en France permettent de tirer les leçons suivantes pour élaborer une politique nationale d'exercices hors site :

- Tirer bénéfice de l'analyse des accidents graves non nucléaires.
- Repérer les gestes professionnels utiles en phase post-accidentelle et les mettre à l'épreuve dans des exercices ou dans des manoeuvres sur le terrain.
- Impliquer des représentants de la population locale.
- Laisser l'initiative des exercices hors site au Préfet, responsable local. Valoriser son initiative par l'apport de prestations spécialisées. Capitaliser les expériences locales au niveau national.

Abstract -

Most exercises on nuclear security have, up to now, be devoted to the accident phase of the installation and the reflex protection measures during the first hours. The post accidental phase, which deals with the characterisation of the contaminated zones and the management of the economic and social life, has been much less tested in exercises.

Three recent exercises performed in France bring the following propositions to work out an off site exercise policy :

- to benefit from the analysis of the non nuclear accidents,
- to select the technical and professional aspects of the off site management and to give them priority in the orientation of the exercises or the manoeuvres,
- to involve representatives of local population,
- to let the initiative to local Prefet. To enhance the value of the local exercises by specialised services. To accumulate these experiences at a national level.

1 - INTRODUCTION

The nuclear security exercises dealing with accidents likely to occur in large installations such as nuclear power plants have been quite usual for several years in France. The actors are the specialized services of operating utilities, of the ministries directly involved and of expert bodies. The organization arrangements and the resources implemented are well identified and regularly tested several times a year on the main nuclear sites.

These exercises include an "off-site" part corresponding to the intervention of local authorities, to the first hours of the accident on the nuclear installation. They aim at preparing and implementing reflex measures to protect the populations threatened : evacuation, sheltering, stable iodine intake, restrictions on circulation or consumption, etc. Besides the above-mentioned players, the Préfet, local representative of the Government and of Ministries, and those responsible for the services directly involved participate also in the exercises.

All these exercises consist in activating decision and expertise centers and in exchanging messages, in response to a scenario simulating the development of a technical accident. There is no or few deployment of intervention means.

To date, only a small number of drills - of all kinds - has dealt with the off-site phase itself, called sometimes post-accidental phase, during which the whole local community would have to cope with an effective contamination of the environment.

Nevertheless, three drills recently performed are worth emphasizing since general lessons may be drawn from them for an off-site exercise policy.

2 - THREE OFF-SITE EXERCISES

2.1 - The first exercise was performed on the Belleville sur Loire nuclear power plant on 14 and 15 June 1990. It was required by the General Secretariat of the Interministerial Committee on Nuclear Security and prepared by IPSN with the advice of Electricité de France, the Direction for the Safety of Nuclear Installations of the Ministry in charge of Industry, the Central Service for Protection against Ionizing Radiations of the Health and Employment Ministries and the Civil Defence Directorate of the Ministry in charge of Internal Affairs. This exercise is typical of an exercise elaborated for the site and extended to the local authorities.

Its originality results from three factors :

- The scenarists added in a second time an off-site phase by simulating by computer a substantial radioactive contamination over wide areas.
- Thirty people selected among the elect, economic agents and local inhabitants were confronted with this contamination situation.
- Some fifteen professional journalists, under agreement and at a national level, covered the event by a broadcast on TV, on the radio and in newspapers in real time following the art of the profession.

Besides, the playing of actors was recorded on video.

2.2 - The second exercise concerned the Golfech nuclear power plant and took place on 5 December 1990. It was required, organized and conducted by the Préfet of the Tarn et Garonne region, local competent authority, assisted by local services.

The themes treated were as follows :

- An intervention on a fire in the turbine building with real movement of 20 fire vehicles in smoke atmosphere.
- The implementation of the so-called PPI emergency plan at level 2, i.e. threaten of radioactive release with setting up of local decision and expertise centers. There was no accident scenario on the site.
- The movement of teams on the routes planned to be followed around the plant in case of crisis by the local teams responsible for the measurement of radioactivity into the environment, without however carrying out real measurements.
- The effective activation of a center to check the population in a school of the town, requisitionned for this purpose.
- The effective circulation of loudspeaker vehicles in the neighbouring towns, under the authority of the concerned mayors.

The main actors defined themselves in large part the themes of the exercise. Strictly speaking, there was no scenario.

2.3 - The third exercise concerned an agricultural area stretching over 30 kms west of the Cadarache research center. This operation was organized by the Atomic Energy Commission (CEA) and its industrial subsidiary company, the General Company for Nuclear Material (COGEMA). The Civil Defence Directorate and the Agriculture and Forestry Direction of the Provence-Alpes-Côte d'Azur region participated in the preparation and in the performance of the exercise.

The scenario assumed that, out of the exercise, an imaginary plant had released radioactive products off the site and that the authorities had taken reflex protection measures by sheltering or evacuating certain populations.

The exercise consisted in dealing with the return of the population to normal life and with the repercussions on the environment and agricultural produces in the areas supposed to be contaminated.

Contamination was either simulated by a computer associating a fictitious activity with any real field measurement or measured in laboratories on samples previously contaminated.

The actors of the exercise were :

- The Préfet, local authority, assisted by agronomists, veterinary surgeons and water experts from the regional administrative and technical services. These experts provided in particular the necessary data concerning agricultural produces.
- Some ten mobile teams specialized in radiological protection from the CEA and COGEMA establishments as well as a mobile firemen team of

- A gamma cartography team transported by helicopter.
- Five CEA and COGEMA analysis laboratories and one laboratory of the local veterinary services.
- An in and out checkpoint and decontamination post for the staff, vehicles and samples.
- An advanced operational command post.
- Two expertise centers, one located at the IPSN, the other at the Préfecture.
- The CEA General Direction Emergency Response Center.

Approximately 150 people participated in the exercise.

3 - REFLECTIONS ON VARIOUS FIELDS RELATED TO THE CRISIS

Contrary to the "installation" phase of a nuclear accident, the "off-site" phase or post-accidental phase involves a very great number of players who are not familiar with nuclear power and represent all the wheels of social life : elected representatives, administrators, economic and social agents, inhabitants. The organizers of the off-site nuclear crisis management have consequently a lot to learn from the experience acquired and from the studies carried out subsequently to major non nuclear accidents which have affected the social and economic life.

In France, researchers and various reflection groups are looking into these questions.

The author of these lines benefited a lot from their commerce.

4 - LESSONS DRAWN FROM THE EXERCISES AND FROM REFLECTIONS FOR THE OFF-SITE PHASE OF NUCLEAR ACCIDENTS

4.1 - Unvarying missions

In crisis period, more than in normal life, the power is to be taken. It is therefore almost impossible to know in advance those who will be involved, in particular as regards politicians, and who in real case would grasp the situation, influence the representations of the crisis, its organization and the decisions.

On the contrary, whatever the power and the organization which will then prevail may be, certain tasks, certain actions to be undertaken will be always of the moment : to carry out measurements in the environment, to draw up a contamination map, to manage the circulation of people, to predict the

repercussions on the surrounding area and on agricultural produces, to control foodstuffs, etc. These are the unvarying missions to be listed and considered as the basis of the exercises.

To try to determine the necessary professional actions is to date, in France, more urgent than to elaborate organization charts to manage the off-site nuclear crisis as a whole.

4.2 - Local population

When studying the running of the social and economic life in all its complexity, we can notice the importance of self-regulatory micro-mechanisms by the side of the outlines of the social organization. These micro-mechanisms are in the hands of social and professional networks enjoying a practical autonomy to work properly : elected representatives-citizens, teachers-pupils, transporters-travellers, health professions-patients, cattle breeders-veterinary surgeons, farmers-agriculture and forestry services, chambers of commerce, of agriculture, etc.

Without neglecting the maintenance of major networks such as water, electricity, communication routes, press, it is essential to involve the key people from these various local networks in the preparation, the performance and the evaluation of the off-site exercises organized by the administration.

This was not the case for the first exercise which in its off-site phase left the administration face to face with the representatives of the population in a dialogue of the deaf.

The two other exercises showed on the contrary that it was possible and beneficial to involve the local agents but that it required particular care.

In the first case, the Préfet was plagued with a vast number of problems which should have been tackled by others and he was not able to solve them. In the two other exercises, the Préfet was also very busy but he was able to work efficiently at his level. His partners and all the players of the exercise were able to carry out relevant professional work. Consequently, there was no more crisis but an exceptional situation treated technically.

Reality would certainly be different but today the priority must be given to technical efficiency in the off-site exercises. This stage reached, the whole crisis management will be considered more favourably.

4.3 - Initiative for off-site exercises

The administrative, legislative and regulatory structure of France implies that :

- The management of accidents on the site of nuclear installations is basically the responsibility of the central organizations of the

administration and of the operating utilities. It is the same for the security exercises associated with this management.

- The management of major **non nuclear** risks is considered by the central organizations but considerable responsibility and autonomy are in fact entrusted to the Préfet of the department.

This difference appears clearly as regards the security exercises. In the first case, the planning is made at the central level. In the second case, the initiative is largely left to the Préfet of the department. What about the off-site management of the consequences of nuclear accidents ? At the present time the question is open. A recent directive from the prime minister opted for a national planning while leaving large initiative to the Préfet of the department. The promotion of the national plan of action concerning the off-site nuclear crises in the coming years depends on the way how this compromise will be settled.

4.4 - Nuclear services

The author of these lines thinks that for the five years to come the best compromise would be as follows :

- To impose on the Préfet a reasonable rate of exercises of an educational or professional nature. To encourage him to deal with a certain number of off-site themes by leaving him the choice and the way to tackle them.
- To have drawn up by the nuclear specialized bodies a list of the services they are able to offer to the Préfet in matters of radiology.
- To have drawn up by the bodies specialized in health, agricultural produces, transports, etc. the list of the services they are themselves able to offer to the Préfet.
- To ask the Préfet to select case by case the players of the local administration and of the local population concerned by the exercise according to the themes chosen.
- To assist the Préfet to prepare, perform and evaluate the exercise in particular with the contribution of human sciences in matters of relationship between the participants.
- To accumulate experiences at the national level in particular by calling on journalistic disciplines : video, internal press, etc.

5 - "OFF-SITE" INTERNATIONAL COLLABORATION

What is true at the national level seems also relevant abroad :

- To leave substantial autonomy to the local person responsible for the protection of the population.
- To register and promote the specialized services.
- To involve the social and economic networks governing normal life every day.

- To prepare exercises which in a first time favour the professional qualification and dialogue.

- To accumulate experiences.

With this in view, the OECD, IAEA and EEC could develop

- the mutual observation;
- the accumulation of experiences;
- the exchange or share of expensive specialized services, in particular air detection.

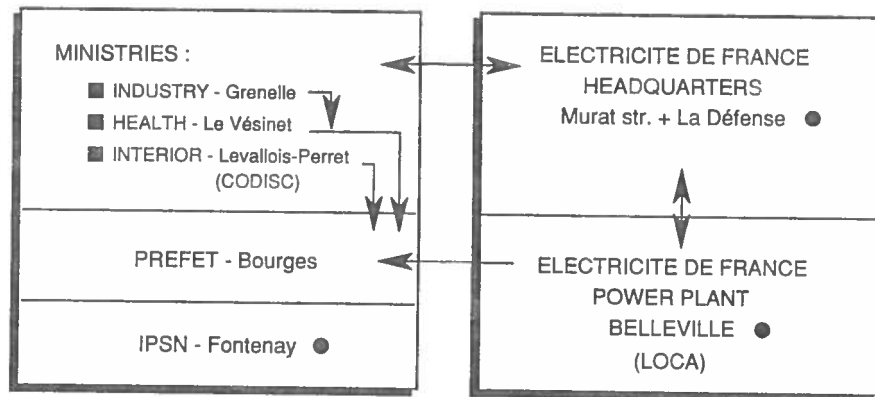

17 PROFESSIONAL JOURNALISTS (CONSULTANTS)
RADIO - TV - WRITTEN PRESS IN REAL TIME (AGENCY)

● On site expertise

Fig.1 : BELLEVILLE-SUR-LOIRE (CHER)
14 and 15 June 1990
COMMAND POST EXERCISE - 1st DAY : ON SITE

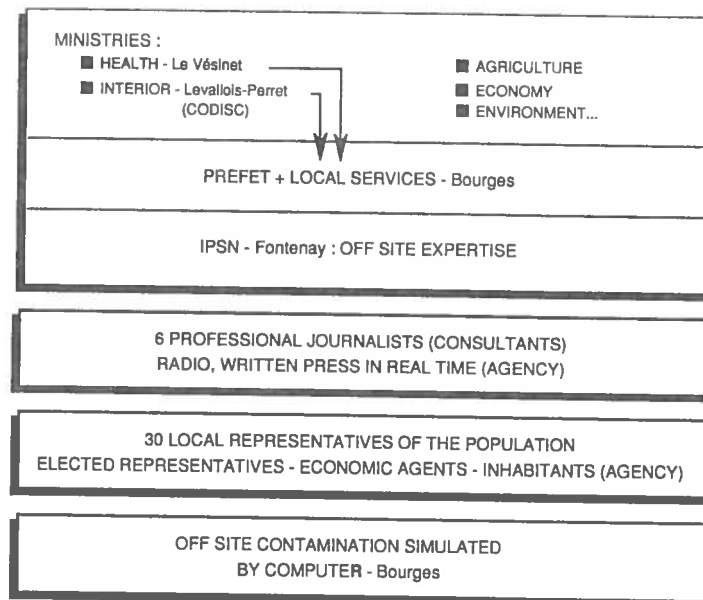

Fig.2 : BELLEVILLE-SUR-LOIRE (CHER)
14 and 15 June 1990
COMMAND POST EXERCISE - 2nd DAY : OFF SITE

PLAYERS PREFET + LOCAL SERVICES
+ LOCAL ELECTRICITE DE FRANCE

NO SCENARIO - KNOWN THEMES :

- FIRE ON CONVENTIONAL GENERATOR : 20 FIRE VEHICLES
- POSSIBLE RADIOACTIVE RELEASE : ACTIVATION OF EMERGENCY CENTERS
- MOVEMENT OF MONITORING LOCAL TEAMS : FIRE BRIGADES - CIVIL DEFENSE AND CEA TEAMS (NO MEASUREMENT)
- ACTIVATION OF A POPULATION CHECK CENTER : REQUISITION OF AN EDUCATION BUILDING
- MOVEMENT OF LOUD SPEAKER VEHICLES IN VILLAGES WITH MAYORS' PARTICIPATION

Fig.3 : GOLFECH (TARN ET GARONNE)
5 December 1990
LIMITED FIELD EXERCISE

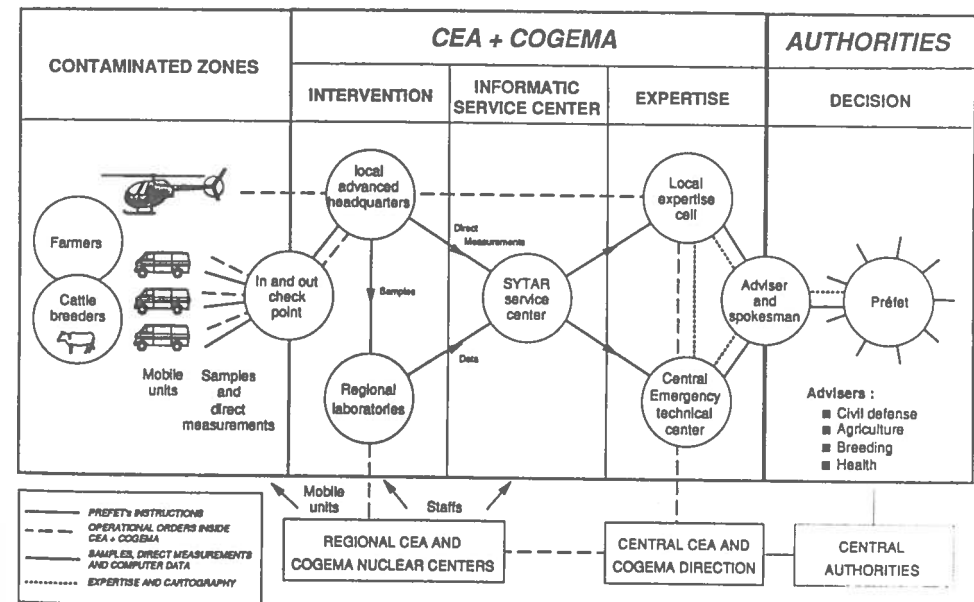

Fig.4 : Field exercise - Cadarache - 14-17 October 1991

Urushihara, Eiji
Science and Technology Agency

Tanizawa, Kiyoshi
Shizuoka Prefectural Government

Oshino, Masao
Japan Atomic Energy Research Institute

Fukuyama, Shigeru
Nuclear Safety Technology Center

1. Overview

Nuclear emergency planning and preparedness in Japan have been organized by both national and local governments based on the Disaster Countermeasures Basic Act.

Off-site nuclear emergency exercises are classified into two types: national-government level exercises and local-government level exercises. National-government level exercises are carried out once a year by the competent national authorities. Among these authorities, the Science and Technology Agency (STA) fills a leading position in the Japanese nuclear emergency planning and preparedness. Local-government level exercises are carried out once a year or once in a few years by the local governments of the prefectures where nuclear facilities are located. Most of the off-site nuclear emergency exercises in Japan are performed by local-governments. The aim of these exercises is to reinforce the skills of the emergency staff.

The national government (STA etc.) provides advices and assistance including financial support to the local-governments. Emergency exercises with the participation of residents have been carried out in some local-governments.

As an example of local-government level exercises, an experience in Shizuoka prefecture (central part of Japan) is presented. (Figure 1)

2. Nuclear Emergency Planning and Preparedness in Japan

(1) Summary of nuclear emergency planning and preparedness

Nuclear emergency planning and preparedness in Japan have been organized within the framework of "the Disaster Countermeasures Basic Act" which covers all kinds of disasters including earthquakes, typhoons, floods and other natural/artificial disasters. The Act also covers nuclear disaster as the "release of large amounts of radioactive materials" to the environment.

The Act designates the Central Disaster Prevention Council, the central organ for disaster prevention in Japan, to make "the Basic Plans for Disaster Prevention". According to the Basic Plans, the designated administrative organs (STA, Ministry of International Trade and Industry (MITI), etc.) and the designated public corporations (electric power companies, Japan Atomic Energy Research Institute (JAERI), etc.) have made their Disaster Prevention Operational Plans, while related local governments have made their Local Disaster Prevention Plans. The primary responsibility of off-site emergency preparedness for nuclear facilities is taken by the local governments. The national government provides advices and assistance including financial support to those local governments. (Figure 2)

(2) Review of the emergency planning and preparedness after TMI and Chernobyl accident

After the accident at Three Miles Island Nuclear Power Plant (TMI) in 1979, the emergency planning and preparedness in Japan were reviewed. The Nuclear

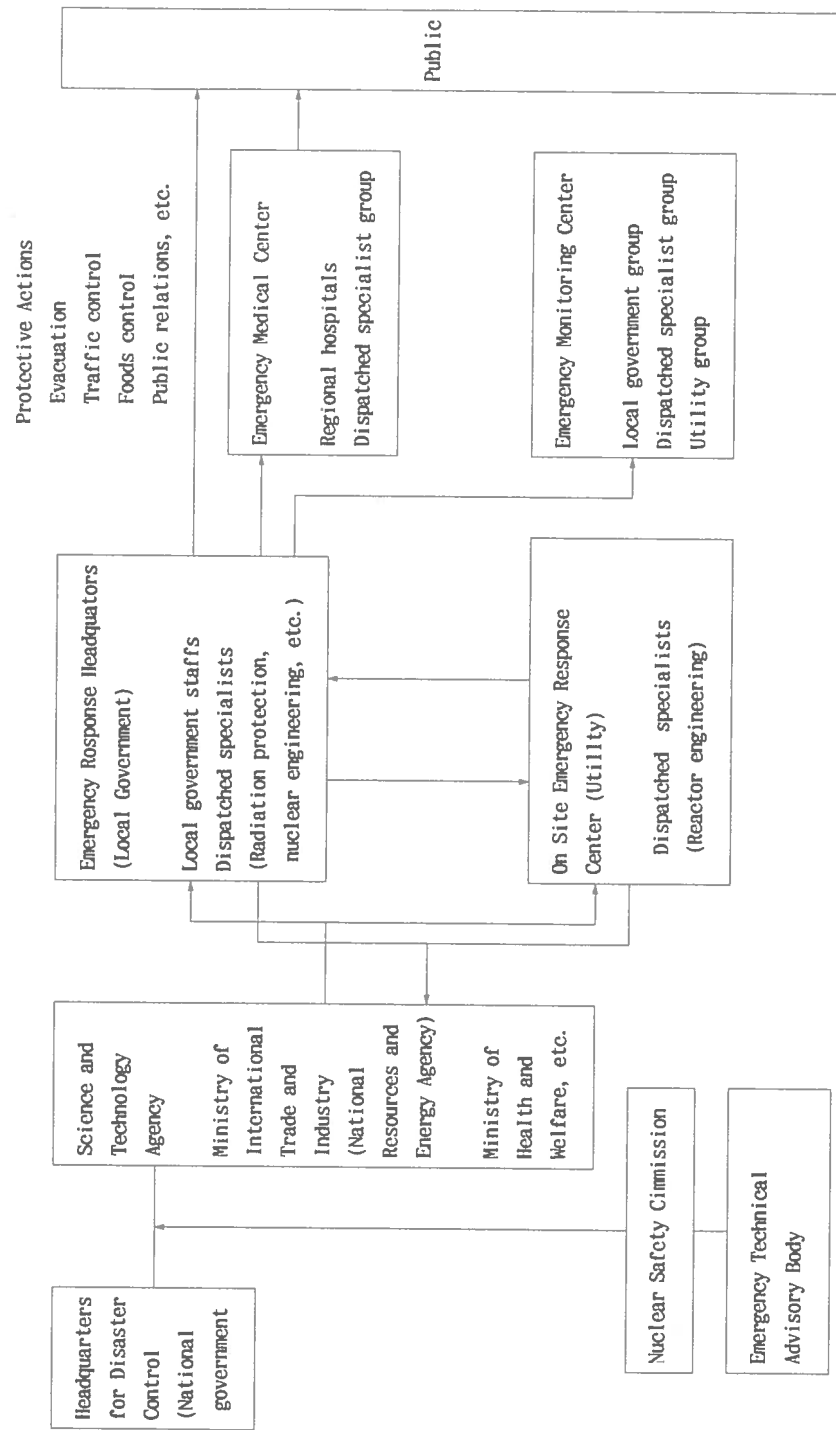

Figure 1 Off-site Nuclear Emergency Response System

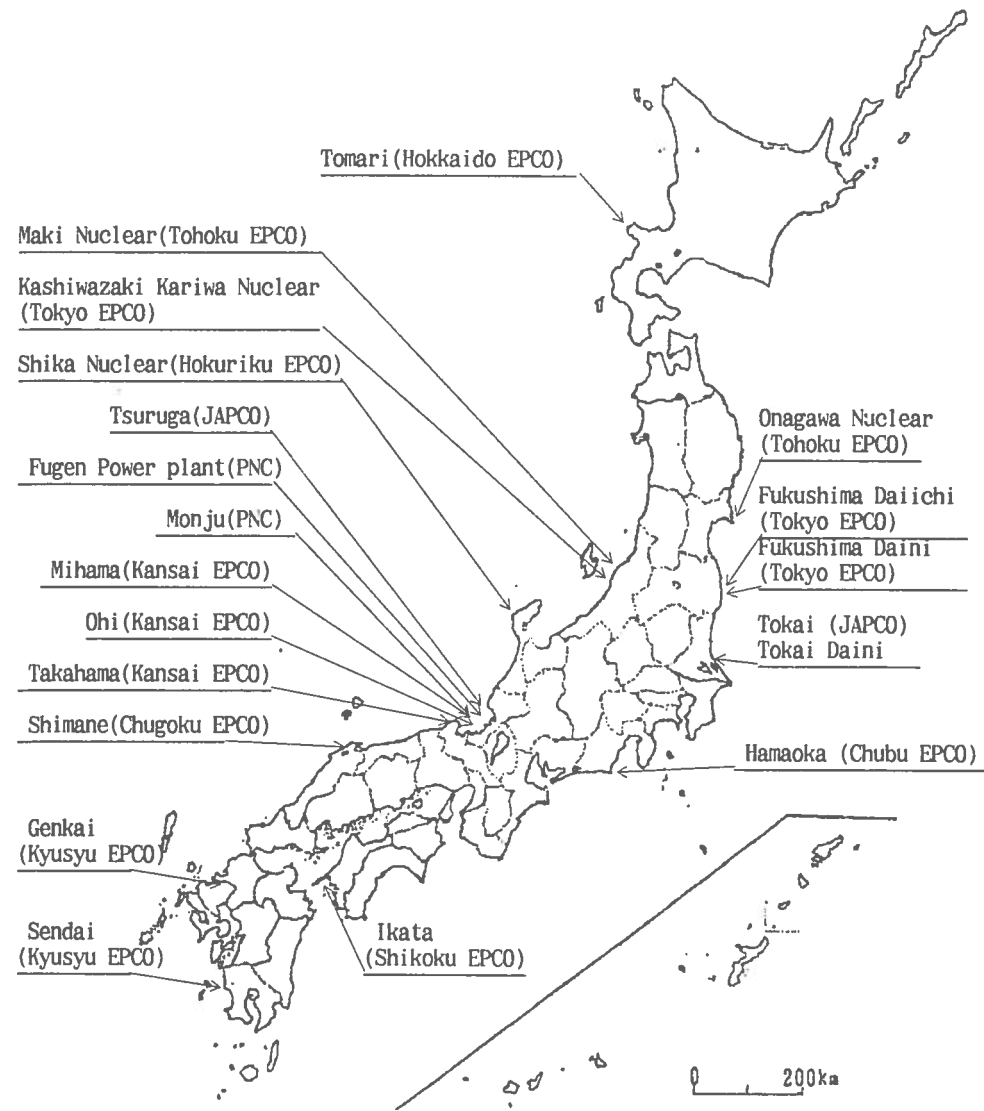

Figure 2 Location of Nuclear Power station in Japan

Safety Commission (NSC), an advisory organ to the national government, set up its Special Committee on Emergency Plans around Nuclear Facilities for investigation on technical aspects of emergency planning. In addition, the NSC set up the Emergency Technical Advisory Body which consists of specialists of nuclear and radiological sciences in order to provide technical advices to the national government in case of emergency.

In July 1979, the Central Disaster Prevention Council specified "Countermeasures to be taken urgently by the governmental agencies for the nuclear facilities". In June 1980, the NSC established its guideline "Off-site Emergency Planning and Preparedness for Nuclear Power Plants (Guideline for off-site emergency)". Then, in the light of this Guideline, the reinforcement of emergency countermeasures at local-government level was made through the revisions of the Local Disaster Prevention Plans.

Furthermore, immediately after the accident at Chernobyl in 1986, reviewing the existing framework of emergency preparedness, the NSC concluded that there was basically no need to change the emergency prevention systems. However, the NSC indicated that further efforts had to be promoted to make the systems more effective, for example, by the establishment of a computer system for the prediction of the distribution map of radiation dose in case of emergency (e.g. "SPEEDI" system).

3. Status of Nuclear Emergency Exercises in Japan

Off-site nuclear emergency exercises in Japan are classified into national-government level exercises and local-government level exercises. National-government level exercises are carried out by the competent national authorities. Among these authorities, STA fills a leading position in the

(2) Emergency exercise at local-government level

Local-government level exercises are carried out under the auspices of local government with advice and support from the national government. Table 1 shows the local-level exercises performed after the TMI accident.

Exercises are basically carried out following the Guideline mentioned above. The types of exercises are mostly field exercises, and command-post exercises are also carried out in some local governments.

As an example, the summary of the exercise in Shizuoka prefecture in 1990 is presented below. In this exercise, 33 organizations with about 500 persons participated.

In the scenario of the exercise, while full-power operation of reactor No.3 at Hamaoka Nuclear Power Plant, abnormal situation occurs in cooling system, the reactor is put to emergency shutdown. Consequently the radiological influence to the off-site is likely to occur. The local governments and the emergency relevant organs are in course to take countermeasures in accordance with the Local Plan for Disaster Prevention.

The contents of the exercise were as follows:

(a) Establishment and operation of the headquarters for disaster countermeasures

Receiving the emergency notification from the national government (regulatory organization : MITI), Shizuoka prefecture established a prefectural headquarters for disaster countermeasures at prefectural capital and the local headquarters at Hamaoka-town.

Table 1. Nuclear Emergency Exercises performed by Local Governments

Prefecture	1980	81	82	83	84	85	86	87	88	89	1990
Hokkaido									○	○	○
Aomori										○	
Miyagi				○	○	○	○	○	○	○	○
Fukushima				○		○		○		○	
Ibaraki		○				○					
Niigata					○		○	△	○	△	○
Shizuoka					○		△	△	△	△	○
Fukui			○							○	
Kyoto			△	△							
Shimane			○				○		○		○
Ehime										○	○
Saga	○	○	○	○	○	○	○	○	○	○	○
Kagoshima				○	○	○	○	○	○	○	○

○: Field Exercise

△: Command-post Exercises

exercises. Local-government level exercises, which seize most of exercises, are carried out by the local governments of the prefectures.

The basic concept of the exercises is indicated in NSC's Guideline. Along the Guideline, exercises for emergency operation staff should be carried out in accordance with the status of preparation of each local emergency response system. It is desirable that the exercises are carried out by the following steps:

- 1) Emergency communication
- 2) Emergency environmental radiation monitoring
- 3) Combination of steps 1) and 2), and notification to residents
- 4) Overall exercise with assistance from the national government

(1) Emergency exercises at national-government level

Under the leading role of the STA that has main responsibilities for off-site emergency preparedness, a nuclear emergency exercise in Japan is performed every year in the occasion of the annual emergency exercise for large-scale earthquake. An example of the scenario of this exercise (command-post exercise) is assumed as follows: a large-scale earthquake of magnitude 8.0 occurs in Tokai area where the Hamaoka Nuclear Power Plant is located, but no trouble occurs in the plant itself.

The exercises are as follows:

- 1) Communication inside the STA
- 2) Communication between the STA and other organizations concerned
- 3) Inspection and check of emergency monitoring devices and other resources;
Operation of computer support system (SPEEDI *)

* SPEEDI: System for prediction of emergency environmental dose information for six hours' advance with meteorological data and radiological source term information

(b) Emergency communication

The drill for correspondence via plural communication methods with the organs related was carried out.

(c) Emergency environmental monitoring

The drill for emergency monitoring activity was carried out by emergency monitoring teams. According to the results of monitoring, sheltering was recommended to be necessary, and this was reported to the director of the local headquarters.

(d) Information transmission to the residents

The decisions at the headquarters were transmitted through the simultaneous radio system and television & radio broadcasting systems to the residents related.

(e) Protective measures

The drills for sheltering and evacuation were carried out.

(f) Emergency medical treatment

Radiation screening team and medical control team were set up. Radiation check for the people by the screening team, comprehensive consultation by doctors in medical control team and emergency transportation were carried out.

(g) Alert and guarding

Control of access by the staff of fire corps and traffic control by policemen were carried out.

(3) Types of exercises

Main type of exercises conducted is local-government level exercise.

Formerly, only communication drills have been carried out as command-post exercises. Recently, communication, emergency monitoring, emergency medical treatment, sheltering or evacuation are carried out as field exercises.

(4) Exercise with the participation of residents

Participation of the related residents to exercises has not been considered to be necessary because the purpose of emergency exercises is mainly to improve the skills of emergency staff in local governments. Presently, there appear some prefectures which carry out exercises with residents' participation for the purpose of enhancing the awareness of the disaster prevention.

4. Summary

(1) Nuclear emergency exercises in Japan have been carried out mostly at local-government level with participations of national authorities.

(2) Main type of exercises is "Field Exercise".

(3) The exercises are carried out based on the Guideline for off-site emergency established by the NSC. They have been effective in verifying the workability of existing disaster prevention system and in upgrading the skills of emergency staff.

(4) Exercises with residents' participation have been also carried out in some prefectures in order to enhance the awareness of the disaster prevention.

(5) Items of future efforts:

- (a) Education and training for new devices such as SPEEDI.
- (b) Enhancement of training for emergency staff
- (c) Public relations and public acceptance of the knowledge of disaster prevention.

PLANNING, CONDUCT AND PRINCIPAL FEATURES OF
NPP EMERGENCY EXERCISES IN SWITZERLAND

Martin Baggenstos
Swiss Nuclear Safety Inspectorate
CH-5232 Villigen-HSK

ABSTRACT

Emergency exercises for each NPP are required on a regular basis by the Swiss Nuclear Safety Inspectorate. The purpose of such exercises is to train the NPP staff and the on-site emergency organization in the application of the emergency procedures and the cooperation with off-site emergency teams and public authorities. The paper discusses the purpose of the emergency exercises and experiences made especially with bilateral exercises. The responsibilities for the preparation and execution of the different emergency exercises in Switzerland are explained.

RESUME

L'autorité de surveillance suisse exige le jeu périodique d'exercices d'urgence, aux fins d'instruire l'état-major d'urgence de l'exploitant à l'utilisation des prescriptions valables pour les situations de dérangements et d'urgence, d'une part, et à la collaboration avec les organes d'intervention extérieurs et les autorités, d'autre part, ainsi que de vérifier cette instruction. On commente les objectifs des exercices d'urgence, les expériences tirées à ce jour de tels exercices - en particulier des exercices bilatéraux, c'est-à-dire avec des organes d'intervention externes - ainsi que les responsabilités et compétences lors de la préparation et de l'exécution de ces exercices en Suisse.

1) Purpose and types of emergency exercises

NPPs in Switzerland are operating since 1969. In the first 10 years (1969 - 1979) emergency exercises were not a legal demand from the nuclear safety inspectorate and were therefore executed on a voluntary basis. Since 1979 emergency exercises are executed on a regular basis. The legal basis was written 1990 in a recommendation of the authority 1).

1.1 Purpose of emergency exercises

Emergency exercises are aimed at promoting the training of all participants involved with an emergency at a nuclear power plant, testing the performance of organizational and technical measures under realistic conditions and increasing overall readiness for an emergency and testing the coordination of on-site and off-site emergency management teams.

The different emergency teams on-site such as shift groups, station security guard, internal fire service, radiation protection group and the communication and alert systems are tested several times a year and are not discussed in this paper.

1.2 Types of emergency exercises

We differentiate principally between technical and security emergency exercises. At the beginning of each accident (or incident) the NPP staff has to check the possibility of sabotage

Evidently in most circumstances this check is very easy and rapidly done. If sabotage cannot be excluded the security guard take a leading role before the technical accident management can begin. To be prepared for managing technical and security accidents three types of exercises are regularly executed:

- table top exercises
- command post exercises
- field exercises

1.2.1 Table top exercises

Designed to train the emergency staff in using the on- and off-site procedures and coordinating with various internal and external agencies. The shift group is normally not involved.

As a scenario a typical case from a PSA-study is normally used. The table top exercise is more an on-site exercise but for each field exercise a table top exercise must be executed in advance. As a typical example the emergency exercise at the NPP Beznau (KKB) from 1989 is illustrated.

Topographical situation

Figure 1 shows the situation of Leibstadt (KKL) a 1000 MW_e BWR and Beznau (KKB) 2*350 MW_e PWR. The two plants have a distance of only 6.5 km from each other. An exercise in one of these plants with a scenario involving the possibility of a release of radioactivity to the environment is a good reason to have (at least) a table top exercise in the other plant. The table top exercise MARTHA from 24.10.1989 at Beznau is shortly described.

Scenario (simplified)

The exercise started at KKL with a leakage in the feedwater system with MSIV closure and SCRAM. After some time all emergency feedwater systems failed with concurrent core melt. The containment failed because of high pressure.

A short time table

- 06³⁰ - feedwater leakage
- failure of emergency core cooling systems
- notification of KKL and HSK staff
- 10⁰³ - high activity inside containment
- 10³⁰ - activation of the off-site alert system

This activation means, that Beznau will also be informed about the accident at Leibstadt.

- 10³⁵ - notification of KKB emergency staff
- the water level inside the reactor falls below the upper bound of fuel elements
- begin of core melt

11³⁰ - siren alert to the public (general alert)

The KKB staff are in close cooperation with the HSK staff to discuss the situation at KKL and to decide the consequences for KKB (two plants still in operation).

The following aspects were discussed:

- shutdown of the KKB plants ?
- closure of visitor centre ?
- planning of special actions, if radioactivity is released by KKL and the wind direction is towards KKB

14⁴⁵ - siren alert to the public (radiation alert)
- the public has to go to shelter

At KKB the two plants are still in operation. The staff is prepared to go to a shielded emergency operation centre and to advise the shift personnel for changing the ventilation of the main control room to circulated air.

1.2.2 Command post exercise

Designed to examine the mobilization and judgement of the essential on-site emergency teams and (depending on scenario) some off-site agencies in handling the plant emergency procedures.

The scenario assumes an emergency situation as defined in the emergency procedures of the plant. (normally a design basis accident from the plant safety analysis report) without significant release of radioactive material to the environment.

1.2.3 Field exercises

Designed to examine the ability of the plant staff for accident management and to exercise the coordinating between the emergency organization on-site and the off-site authorities and measurements teams.

The scenario assumes a situation, which goes beyond the design of the plant (normally a core melt accident with releases of radioactive materials up to the emergency planning source term).

2) Recommendations for planning and execution of emergency exercises

The recommendations published 1990 were made in close co-operation between the utilities and the nuclear safety inspectorate. They contain:

- aim and scope of the three different types of emergency exercises
- outline scenarios and frequencies
- participants and their duties
- responsibilities for planning and execution of exercises

A time schedule of the exercises for each plant till 1990 (Table I+II+III) is enclosed. Special attention is given in the recommendations to the field exercises.

2.1 Principles for field exercises

In the scenario, the necessary countermeasures which should be taken by the NPP personnel to control the plant should be realistically taken into consideration. For managing the plant status the scenarios should include mainly design basis accidents with additional problems for example the failure of components or rupture of systems containing radioactivity. For the examination of the external agencies arbitrary releases (not necessarily corresponding to the technical scenario) may be chosen.

2.2 Outline scenarios for PWRs

Loss of coolant accident

Steam generator tube rupture

Small leak inside/outside the containment (V sequence possible) with problems with the emergency core cooling

Off-gas system failure (explosion/pipe break)

2.3 Outline scenarios for BWRs

Loss of coolant accident within the containment or in the turbine building. Additional problems with the emergency core cooling result in damage to the fuel cladding

Explosion in the off-gas piping (immediate release)

Fire in the turbine building with additional problems in the off-gas system. (release over a long period via the roof of the turbine building).

2.4 Outline scenarios for use in PWRs and BWRs

Loss of normal on-site and off-site electrical power. Additional failure of emergency diesel which leads to short or long term problems with emergency feed water / emergency core cooling.

Fuel element handling accident with additional problems in isolating the fuel element building. (direct release of radioactivity to the environment)

3) Responsibility for planning and execution of emergency exercises

The responsibilities are shown in table IV. For table top and command post exercises the utility and the nuclear safety inspectorate (for security exercises the Section Nuclear Technology and Security) have the main responsibility.

For field exercises the emergency organisation for radioactivity (federal level) for technical- and the state police department for security exercises take the leading role.

A special task group is set-up for planning and execution of exercises.

The time schedule is as follow

first quarter	Fixation of date of a year, definition of scenario (draft)	
	approval of date and scenario evaluation of participants	
H-3 weeks	definition of final,detailed scenario evaluation of exercise control group	
H-0	exercise	
H+ 2h	post exercise evaluator debriefing immediately following the exercise	
H+2 months	exercise report by the control teams including recommendation for corrective actions	
H+6 months	control of execution of corrective actions	

4) Experience from exercises

4.1 Responsibility for accident management

Throughout an accident a lot of decisions have to be taken on- and off-site. The responsibility is normally divided, so that decisions on-site have to be taken by the NPP staff and off-site by the federal emergency organization. It is undoubted, that some accident management decisions on-site have a direct impact off-site. Therefore it is very important, that the NPP staff know the off-site responsibilities and organization very well and that it is harmonised in advance which decisions on-site need permission from an off-site authority . A typical example is the activation of the containment venting system. The NPP staff get a special instruction about the off-site responsibilities and organization.

4.2 Communication network

A good communication network is essential for managing an accident. It is important to use the same communication devices for exercises as for accidents. A reliable communication is only possible with dedicated lines, so that all agencies involved in a emergency must be connected with such dedicated lines.

4.3 Confidentiality

All decision taken in a accident are very sensitive to public criticisme. It is therefore important, that all on- and off-site staffs know each other and know also the ideas which are behind each decision.

Reference

- [1] Recommendations for the Planning and Execution of Emergency Exercises in Swiss Nuclear Power Plants, Swiss Federal Nuclear Safety Inspectorate (HSK) 1990 Edition

Germany

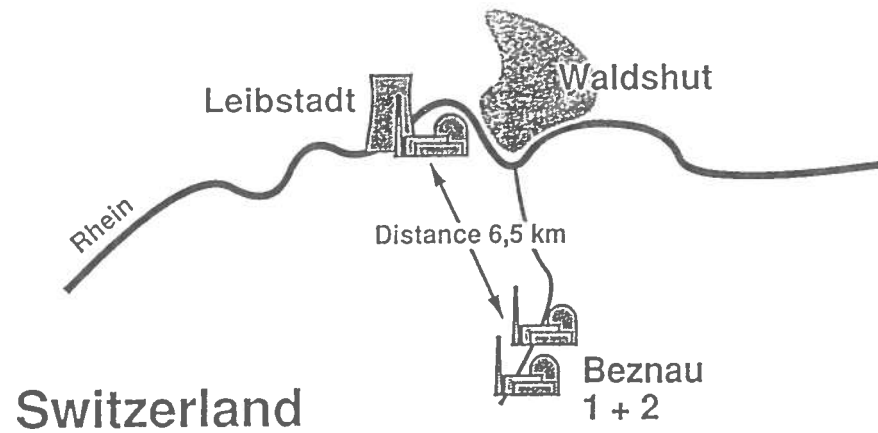

Figure 1 Topographical situation of the NPP in northern part of Switzerland

Plant	Table top exercise	Command - post exercise	Field exercise
Gösgen	2	11	1
Leibstadt	0	5	1
Mühleberg	(1991)	11	(1992)
Beznau	2	8	1

Team	Frequency
Fire brigade	13 x
Sanitary team	12 x
Police	5 x
Radiation measurement team *	3 x

* radiation measurement teams off - site are involved only in field exercises

Exercise type	ON - SITE	OFF - SITE
table top	entire emergency staff	HSK - NFO NAZ State authority } partly
command post	emergency staff partly shift team NPP-fire brigade NPP-sanitary team NPP-security guard NPP-radiation protection team } depending off scenario	HSK - NFO partly fire brigade sanitary teams } depending off scenario police
field exercise	entire emergency staff shift team security guard ON - site teams depending off scenario utility support group	HSK-NFO NAZ State authority Federal management team } entire OFF - site intervention teams depending off scenario radiation measurement organization
HSK - NFO NAZ	Emergency Organization of Nuclear Safety Inspectorate National Emergency Operation Centre	

Table IV Responsibility for planning of emergency exercise					
	fixaten of DATE	definition of SCENARIO	evaluation of PARTICIPANTS	CONTROL of Exercise	Frequency
TECHNICAL					
table top	NPP	NPP + HSK *	NPP	HSK	1 in 8 year
command post	NPP	NPP	NPP	HSK	every 3 years
field exercise	EOR **	EOR + HSK + EOR	EOR	HSK + EOR	1 in 8 year
SECURITY					
table top	NPP	NPP + NS*** + HSK	NS	HSK + NS	1 in 8 year
command post	NPP	NPP	NPP	HSK + NS	every 3 years 1 in 8 year
field exercise	KaPo ****	KaPo + NS + HSK	NS	KaPo + NS + HSK	

- * HSK Swiss Federal Nuclear Safety Inspectorate
- ** EOR Emergency Organisation for Radioactivity (federal level)
- *** NS Section Nuclear Technology and Security
- **** KaPo State Police Office

SESSION IV

INTERNATIONAL EXERCISE PROGRAMME

CHAIRMAN

D. ROHRER
(UNITED STATES)

REVIEW OF THE EMERGENCY RESPONSE EXERCISE
ORGANISED DURING THE ERPET TRAINING COURSE ON
OFF-SITE EMERGENCY PLANNING AND RESPONSE
FOR NUCLEAR ACCIDENTS
on 12 September 1991
at SCK/CEN - Mol - Belgium

P. Govaerts, M. Loos, A. Sohier
M. Van Camp, Th. Zeevaert
SCK/CEN
B-2400 Mol (Belgium)

ABSTRACT

An international training course on off-site emergency planning and response for nuclear accidents has been organised by the SCK/CEN (Studiecentrum voor Kernenergie - Centre d'Etude de l'Energie Nucléaire) at Mol (Belgium) from 9 to 13 September 1991. One of the major events of this training course was a full-day emergency exercise. An emergency response exercise organised in the frame of a general course has more specific aspects, regarding the role of the participants and the absence of a specific emergency plan or procedures. This paper describes the practical organisation, the scenario and the communication with the participants. The decisions proposed by the participants and the results of their radiological evaluations are discussed.

1. INTRODUCTION

An international training course on off-site emergency planning and response for nuclear accidents has been organised by the SCK/CEN (Studiecentrum voor Kernenergie - Centre d'Etude de l'Energie Nucléaire) at Mol from 9 to 13 September 1991. This course was co-sponsored by the Commission of the European Communities (DGXI - DGXII) in the frame of the ERPET (European Radiation Protection Education and Training) programme. The main objectives of this programme are the conservation of the radiation protection know-how from the first nuclear experts generation and its transfer to younger experts and the homogenisation of radiation protection practices in view of the European common market of 1993.

The course has been attended by 55 participants from 19 countries. The background of the trainees was rather heterogeneous : scientists, authorities, licencees ...

The programme of the training course is added as annex 1. Twenty-two communications (50 minutes) discussed topics as : accident source terms, consequences, health aspects, design and organisation of an emergency plan, principles and criteria for intervention, countermeasures, assessment techniques, environmental monitoring and decision aiding techniques. One of the major events of the training course was a full-day emergency exercise.

2. OBJECTIVES OF THE EXERCISE

An emergency exercise organised in the frame of a general training course differs in many ways from a conventional exercise organised to check deficiencies in an operational emergency plan or to drill procedures to different teams, assigned to specific roles in an existing plan. Such an exercise does not aim to test an emergency plan, neither to test an emergency response infrastructure, nor an emergency response team. The objectives are :

- to train students on emergency assessments and on decision shaping ;
- to let realize the needs on logistical support and on a well developed communication system ;
- to give a taste of the related stress and the pressure induced by the media.

3. ORGANISATION OF THE EXERCISE

The participants were dispersed over 7 parallel groups. Each group had the same function, i.e. radiological assessment and decision shaping, on the basis of information given by an organising team. This information was distributed at the initiative of the organising team or at the request of a group. The organising team decided whether specifically requested information was addressed to the group asking for it or to each group. The organising team was composed of 5 persons, having prepared the exercise. This team was responsible for the time management during the exercise by the control of communications and for the supply of specific information requested by the participants. Information has been communicated by a local area network, interconnecting

8 personal computers. All messages were automatically printed. Each group and the organising team had a PC and a printer at their disposal.

The exercise has been introduced by two lectures, during the afternoon preceding the exercise. A first one reviewed simple assessment techniques to allow the participants to perform manual assessments. A second one presented some data bases with respect to the installation, the site, demography, socio-economic data ... and clarified the objectives and the structure of the exercise.

The exercise itself started at 9 a.m. and continued up to 4 p.m. without break. The results were discussed during a short debriefing.

4. THE ACCIDENT SCENARIO

The accident assumed a core melt in a 1000 MWe PWR reactor leading to a hold-up of the fission products in the reactor building during ten hours. After this period the reactor building failed and depressurized exponentially over a period of two hours. The release fractions are summarized by table I. The assumed delay between the shut-down of the reactor and the onset of the release reduced the importance of short-living radionuclides.

Table I : Release fractions

Noble gases : 75 %
Iodine* : 0,5 %
Caesium : 0,3 %
Tellurium : 0,1 %
Barium-Strontium : 0,03 %
* 2/3 organic, 1/6 elemental, 1/6 aerosol

The meteorological conditions were kept relatively simple and invariant during the whole episode : neutral stability and low wind speed. Figure 1 shows the thyroid dose by inhalation and the integrated effective dose by external exposure, as a function of the distance under the plume axis.

5. MESSAGES TO THE PARTICIPANTS

A set of common messages was periodically transmitted to all participants as discussed by point 3. A summary of these messages is given by table II.

Table II : Central messages to all participants

09:00	Notification of alarm Type of accident Characteristics of installation Meteo characteristics "No release up to now"
10:05	Release started at 10:00 Stack monitoring out of range Survey teams in stand-by
10:30	Results direct γ measurements from 2 monitoring stations
10:40	3 irradiated workers evacuated to hospital
10:50	Meteo situation : unchanged since 09:00 New results γ -fixed monitoring studies from PCS 3 and 4 (from now on, regulary given)
11:00	Time bound to 12:00 11:00 (reality) = 12:00 (exercise) Meteo situation unchanged
12:15 (ex.)	Release stopped at 12:00
12:25	I-131 and Cs-137 air concentrations measured at PCS 3 and PCS 4 at 10:30
12:35	γ measurements in Dessel at 11:00 and 12:15
12:45	γ measurements in Heide at 12:30
12:50	I-131 and Cs-137 air concentrations measured at PCS 3 at 11:30
13:00	γ measurements in Witgoor at 12:30
13:10	Results deposition measurements in Dessel at 13:00 (nuclide-specific)
13:20	Results spectrometry on grass samples at 2 km from point of release
14:20	γ measurements under plume axis at 5 km
14:45	Normalized air concentrations in the environment

During the release only answers by fixed γ -monitors were given. At the end of the release period, the exercise-time shifted to the real time by one hour, in order to compress the time scale. Progressively more detailed information was given about global and radionuclide specific airborne concentrations, external dose rate due to ground deposits and spectrometry of soil and grass samples.

6. REPORTING BY THE PARTICIPANTS

Each group was asked to propose protective actions to the authorities and to make press communications. A spokesman of each group has been interviewed by a journalist. At the end of the exercise a report, using a specified format, has been prepared by the participants. This report allows to check specific intermediate results of the evaluation and to compare proposed actions.

Figures 2, 3 and 4 compare some typical results of the seven groups with the exact value. Figures 3 and 4 show the correlation between the assessed dose in a reference point, proportional to the assessed doses for all distances and the proposed ranges for countermeasures.

It is obvious that the numerical results show a spread over several orders of magnitude. This does not lead to an equivalent spread of the proposed ranges. It seems that the groups had some reluctance to deviate from the conventional ranges, withhold for emergency planning, e.g. 10 to 30 km.

7. DISCUSSION

An emergency exercise in the frame of a general training course shows many specific aspects :

- the heterogeneity of participants
- the absence of predefined roles and hierarchy for the individual participants
- the absence of an emergency plan and procedures.

A typical problem is presented by the assembling of equilibrated groups, considering prime movers, spokesmen, clans of people joined on the base of nationality, language or professional background. The exercise has to cope with a dead time to allow familiarizing with the group, the site and the communication system. It is interesting to analyse the large range of numerical results. It should be worthwhile to repeat the same exercise with experts or trained people. The conclusions might not be so different. The main difficulty seems to be the correct understanding of the environmental monitoring results and the extrapolation of these results to dose assessments for the whole area.

Such an exercise should give a taste of everything, with much emphasis on the environmental stress, the fear to communicate wrong conclusions, the art of making a synthesis of the essential facts to communicate with the press and the need for internal organization of the evaluation team.

We intend to spend more time in the future to elucidate the decision logics effectively applied by each group and to reduce the emphasis on numerical evaluations of the environmental contamination.

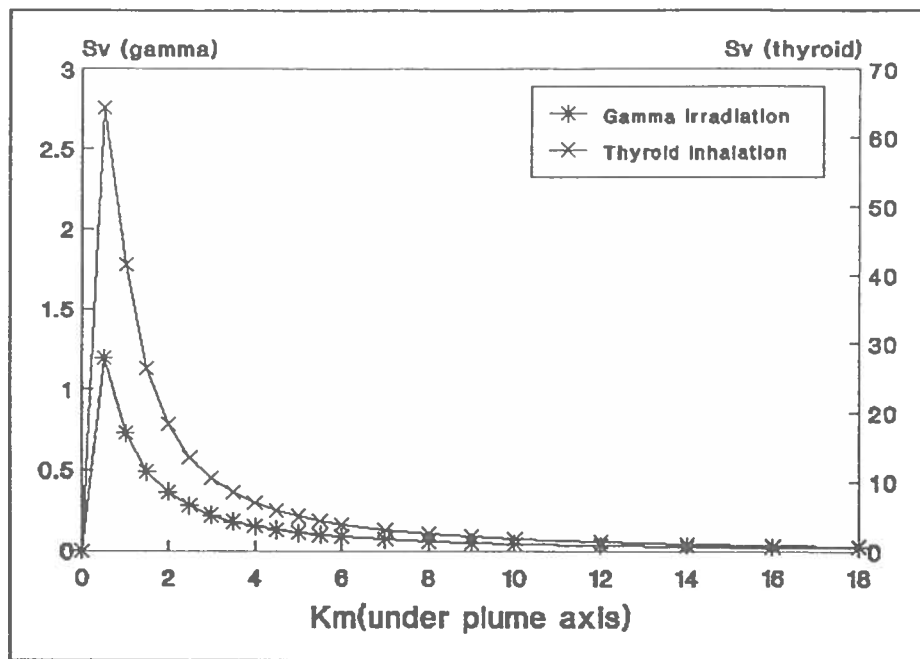

FIG. 1.

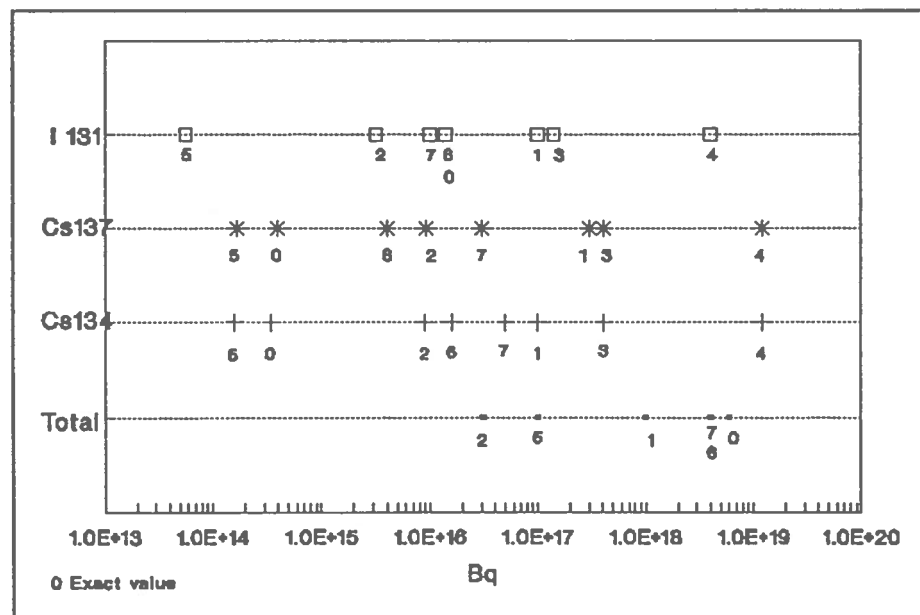

FIG. 2. : Source term estimates by different groups.

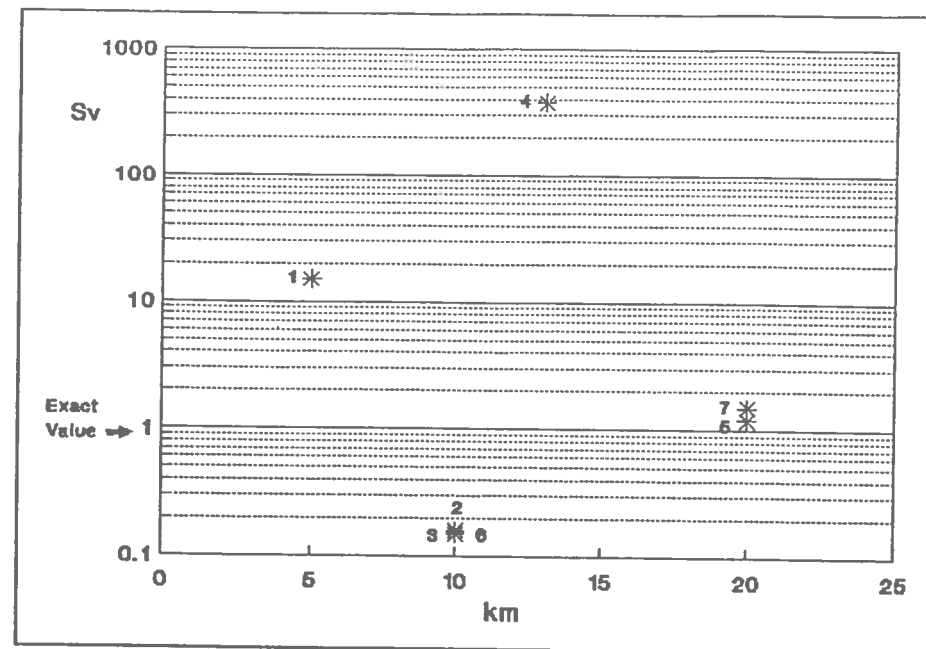

FIG. 3. : Stable Iodine distribution range proposed by different groups, related to a representative dose estimate.

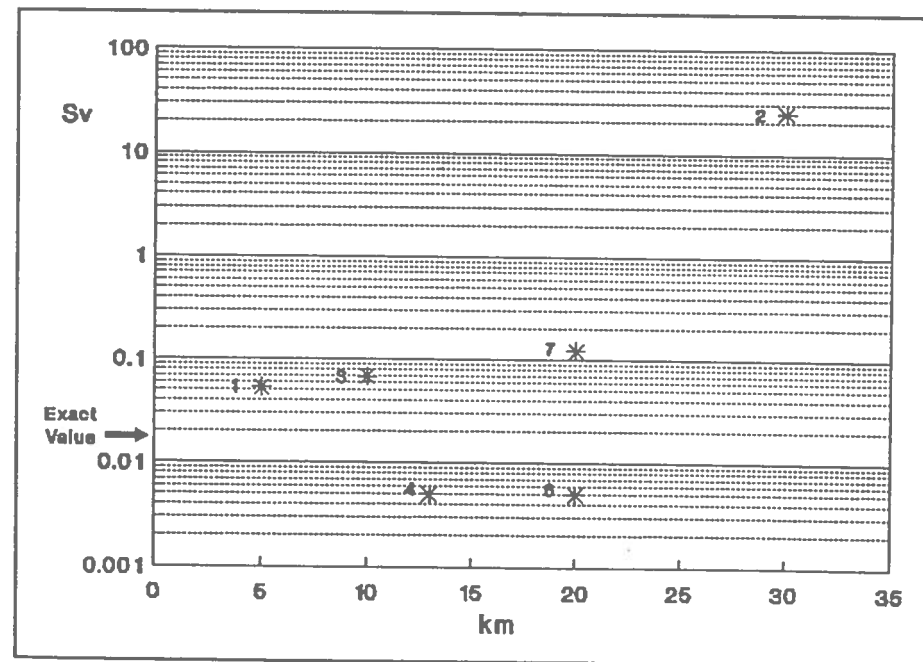

FIG. 4. : Evacuation range proposed by different groups, related to a representative dose estimate.

EUROPEAN RADIATION PROTECTION EDUCATION AND TRAINING (ERPET)**Training Course on****OFF-SITE EMERGENCY PLANNING AND RESPONSE FOR NUCLEAR ACCIDENTS****SCK/CEN, Mol (Belgium), 9 - 13 September 1991****Programme**Monday, 9 September

09:00-09:30	Welcome on behalf of the SCK/CEN	C.M. Malbrain
	Welcome on behalf of the CEC	J. Sinnaeve
09:30-10:20	Review of potential accidents requiring off-site emergency planning	P. Govaerts
10:20-10:50	Break	
10:50-11:40	Review of past accidents	J. Lakey
11:40-12:30	Consequences of accidental releases of radioactive materials. I.	M. Morrey
14:00-14:50	Consequences of accidental releases of radioactive materials. II.	M. Morrey
14:50-15:40	Health aspects	G.B. Gerber
15:40-16:10	Break	
16:10-17:00	Principles of interventions	G.N. Kelly
17:00-17:50	The basis of emergency planning	C. Viktorsson
18:00	Cocktail	

Tuesday, 10 September

08:30-09:20	Interventions during the early phase	M. Morrey
09:20-10:10	Practical organisation of an emergency plan	J. Lakey
10:10-10:30	Break	
10:30-11:20	Real-time consequence assessments. I.	J. Ehrhardt
11:20-12.10	Real-time consequence assessments. II.	J. Ehrhardt
13:00	Departure to Doel	
14:30-17:00	Visit of the Doel Nuclear Power Plant	KC-Doel
	Lecture on on-site emergency planning	P. Walthoff

Wednesday, 11 September

08:30-09:20	General aspects of an off-site emergency plan	P. Hedemann Jensen
09:20-10:10	Regional monitoring networks and international data exchange	F. Raes

10:10-10:40	Monitoring of the nearby environment and the contamination of members of the public	G. Lemaire
10:40-11:30	Break	
11:30-12:20	International guidance on intervention criteria	P. Hedemann Jensen
13:30-16:00	Visit to the SCK/CEN laboratories	
16:00-16:30	Break	
16:30-17:20	Interventions related to the foodchain	F. Luykx
17:20-18:00	Introduction and practical organisation of the emergency response exercise	Th. Zeevaert
18:00-18:50	Simple techniques for the assessment of off-site consequences of nuclear accidents	A. Sohler

Thursday, 12 September

08:30-15:30	Emergency response exercise	SCK/CEN
15:30-16:00	Break	
16:00-17:20	Debriefing and analysis of the assessments and decision making during the exercise	
20:00	Course dinner	

Friday, 13 September

08:30-09:20	Decision aiding techniques : methodology	J. Lochard
09:20-10:00	Decision aiding techniques : application for the "Chernobyl project"	J. Lochard
10:00-10:30	Break	
10:30-11:20	The international nuclear event scale	J.P. Deworm
11:20-12:10	Telerad	P. Govaerts
12:10-13:00	Summary discussion and evaluation of the training course	SCK/CEN

Plan for International Emergency Exercises

by

The NEA Expert Group on Nuclear Emergency Exercises ¹⁾

ABSTRACT

Emergency exercises provide an effective means to identify deficiencies in emergency provisions. Periodic execution of exercises and drills is for this reason considered an integral part of the overall regulatory requirement for nuclear installations. When the impact of a nuclear accident affects more than one country, particular problems in applying emergency provisions may be experienced. This was certainly demonstrated during the Chernobyl accident. For this reason the OECD Nuclear Energy Agency has taken an initiative to promote international co-operation on off-site emergency exercises and have established a programme of work in this field. This programme includes as a major component the arrangement of international emergency exercises. The NEA Expert Group on Emergency Exercises, which is in charge of this programme, presents in this paper a first draft proposal on the arrangement of such international exercises.

Members of the Expert Group: Mr. J. Bond, Canada, Mr. P. Ginot, France, Mr. J.O. Snihs, Sweden, Mr. M. Baggenstos, Switzerland, Mr. J.A. Driscoll, United Kingdom, Mr. D. Rohrer, United States, Mr. B. Weiss, IAEA, Mr. V. Ciani and Mr. G. Fraser, CEC and Mr. C. Viktorsson, NEA.

1. INTRODUCTION

An important component of the provisions which are made at nuclear facilities to mitigate the radiological consequences of a nuclear accident is the existence of adequate emergency planning and preparedness arrangements. If they are to remain effective, however, they have to be regularly and thoroughly rehearsed. Periodic execution of drills and emergency exercises is, therefore, a regulatory requirement in countries with nuclear installations. Deficiencies in emergency provisions and procedures are more easily identified in an exercise than in any critical review of such provisions and procedures. Furthermore, organisations that are not normally connected by their day-to-day work can, in the context of exercises, establish closer personal acquaintances and identify practicalities of overriding importance. Of special interest is the cooperation of all organisations that have responsibilities at the time of an accident.

Particular problems in applying emergency provisions may be experienced when the impact of a nuclear accident affects more than one country, due to differences in the respective organisational set-up, emergency zones, alert and intervention criteria, etc. as well as to different public information policies. For this reason, the OECD Nuclear Energy Agency, NEA, has taken the initiative to promote international co-operation on off-site nuclear emergency exercises. The NEA Committee on Radiation Protection and Public Health (CRPPH) established in 1990 an Expert Group on Emergency Exercises to prepare a proposal in this respect. Such a proposal was discussed and adopted by the Committee in late 1990.

2. PURPOSE OF THE NEA PROGRAMME

The CRPPH identified two basic purposes of its international co-operative programme in the area of off-site emergency exercises, namely:

- to improve the quality and the coordination of emergency response systems on a "regional" scale, in particular in the case where countries have borders in common, and,
- to help in seeking consensus on approaches to the management of nuclear emergencies between countries which are not necessarily linked

to each other with a common border or by being situated in the same region.

The programme consists of two parts, the first one concerns information exchange on national practices and lessons learnt from off-site emergency exercises and the second one the arrangement of international emergency exercises.

The information exchange part of the programme started in early 1991 with the collection of information on national practices and lessons learnt from off-site emergency exercises and has continued with the organisation of this Workshop on Off-site Emergency Exercises. A proposal for the second part of the programme, the arrangement of international exercises, will be submitted for endorsement to the CRPPH at its next meeting in February 1992. The preliminary plan discussed below reflects the first ideas of the Expert Group and is presented to the Workshop for the purpose of getting comments and suggestions by the Workshop participants. Following the Workshop, the Expert Group will finalise the proposal taking into consideration the comments and suggestions received.

3. PLAN FOR INTERNATIONAL EMERGENCY EXERCISES

General

The Expert Group thinks that the primary goal of international emergency exercises should be to contribute to the identification of those aspects of off-site emergency response planning which would greatly benefit from international co-operation. Such aspects not only refer to international arrangements in the field of emergency response planning, but also to the national approaches to the management of nuclear emergencies. Examples referred to are systems and procedures for notification and communication, consequence assessment methods, monitoring strategies and procedures, methodology and reporting of measurements, intervention criteria and levels, radiological aspects concerning international trade, public information policies and procedures, etc.

Through international emergency exercises, interfaces of national emergency response plans would be understood and commonalities and inadequacies identified. Moreover, the approaches to the management of nuclear emergencies used in the various countries would be highlighted and examined, possibly leading to increased mutual understanding between the various countries participating in the exercises.

International emergency exercises would also offer an unique opportunity to examine these issues, especially in the situation of development and change which currently characterises the arena of nuclear emergency management. At the same time, they would provide an effective means for participating countries to consider in an international context their own approaches to emergency planning and to exercises to test it.

Various types of emergency exercises are carried out on a national level and could be considered for the international programme. As reported in the NEA Survey paper in Session I, so called "table-top" exercises have proved useful in testing and evaluating policy aspects of emergency arrangements. "Command-post" and "field" exercises on the other hand, in providing a more realistic setting for the various players, are of special value when one wants to evaluate operational aspect of emergency response schemes. Further details of these three exercise types are given in the previously mentioned NEA Survey paper.

The Expert Group also feels that it would be appropriate to start modestly, and is therefore proposing the first exercise to focus on the following important components of off-site emergency response planning: notification and communication in emergency situations, monitoring strategies, methods for consequence assessment, intervention criteria and radiological aspects of international trade. Moreover, the Group thinks that the first exercise should be of a table-top type, but assuming participants to act in their own countries on a common scenario (taking place in a fictitious country, ACCILAND) and using their own emergency plans as the basis for the responses. These table-tops will then be followed by a meeting to discuss their results. It is expected that this type of set-up will give rise to an in-depth discussion on various possible approaches to respond to a nuclear emergency.

Later, other exercises could be envisaged, for example, simulating a situation where all participants act on an accident in a domestic real site. Experience will however be needed before embarking on such exercises.

Specific Objectives and Method for the First Exercise

As indicated above the first exercise is proposed to consist of two phases, phase 1 containing the national table-tops and phase 2 containing the common discussion meeting. The exercise will assume that all participants are in the same identical situation, i.e. responsible for the emergency response in a fictitious country. When the accident happens, they will be asked to deal with the topics listed below. In responding to the emergency, the participants will be

asked to base the response on the actual emergency plans and criteria of their respective countries. The following tasks will be given to the participants:

- a) to simulate actions for alerting and informing neighbouring countries in case of radiological emergency;
- b) to decide on appropriate monitoring strategies for assisting decision making on protective actions;
- c) to assess the consequences of airborne releases of radioactive substances (air concentrations, ground contamination levels, individual doses to members of the public, etc.);
- d) to decide on intervention levels and protective measures, and
- e) to take appropriate actions in relation to the export and import of contaminated food and feed stuff.

Finally, the capabilities of and the assistance provided by international organisations are proposed to be included as a topic to be dealt with in the first exercise.

Participation

All member countries of the OECD will be invited to participate, and are referred to as participants. As the exercise will be focussing on radiological aspects, it is foreseen that radiation protection authorities and advisory bodies to those will be representing the participants in the discussion of the results. The participation in phase 1, however, the conduct of the national table-top exercises, might vary from country to country depending on the national set-ups. Finally, the IAEA and the CEC will be invited to participate in view of their specific roles in nuclear emergencies.

Conduct and Management of the Exercise

The accident scenario will be communicated to the countries participating in advance of the exercise and given to the players by an exercise moderator, who has to be nominated by each participating country. On the day of the exercise, the exercise moderator in each country will start the exercise, by a prepared message giving the information available at the moment. The exercise moderator will feed the players with the scenario and the other information that has been sent to him. In addition to radiological measurement data, the exercise

moderator might need other feeding material, like announcements/press releases on the accident issued by the operator or the government, requests for assistance from neighbouring countries or international organisations, etc. This type of information, which has to be submitted to the players successively, has of course to be adapted to the objectives of the exercise.

The national responses will, as mentioned above, be discussed in phase 2 in the presence of representatives of all participants (the exercise moderators and the persons responsible for the emergency responses), who are supposed to come to the phase 2 meeting prepared to present and discuss the emergency response of the country they represent. This provides an opportunity for identifying commonalities and weaknesses in national emergency responses and to identify areas where interfaces would be essential to develop or maintain between countries. In addition to a discussion about the emergency responses, the participants will be asked to comment on the planning and the conduct of the exercise and to give suggestions for future exercises.

To guide the discussions in the phase 2 meeting, the same scenario will be given to participants, who will be asked to respond to the various phases of the scenario.

Scenario

First, it has to be kept in mind that in this exercise all participants will be put in identical situations; they will be assumed to be responsible for the emergency planning/radiological protection in a hypothetical country, which we could call ACCILAND. The reason for choosing a fictitious country is that it will facilitate the discussions of the results. It will also avoid the somewhat sensitive question of where to simulate the accident. A map of ACCILAND and information about the reactor, the population, the agricultural and industrial resources, etc. will have to be given to the participants. Furthermore, the scenario will have to include times of events, event descriptions, the time of the year, meteorological and radiological data, etc.

Exercise Planning

The Expert Group will be responsible for the exercise and act as a Project Management Group. However, to facilitate the planning and conduct of the exercise, an Ad-hoc Group is proposed to be formed, including the exercise moderators and the Expert Group members. The so formed Ad-hoc Group will be the Group that agrees all the necessary specifications for the exercise.

Finally, one country, or an NEA consultant, will have to be approached by the Project Management Group to prepare the scenario and the related data sets based on guidance from the Group.

Time Schedule

The following time schedule is proposed:

December 1991-January 1992	Finalisation of the Proposal to the CRPPH. The proposal will take into consideration the conclusions from the Workshop in the Hague.
February 1992, 25-26	Meeting of the CRPPH.
February 1992, 27-28	The Ad-hoc Group, starts the detailed planning, including the preparation of the scenario.
June 1992	The Ad-hoc Group finalises the exercise specifications.
October - December 1992	First exercise conducted. Phase 1 during October-November. Phase 2 during the first half of December.

4. FUTURE EXERCISES

Following the first exercise, the Expert Group thinks that a second exercise with a broader scope, including aspects which were not dealt with in the first exercise, should be arranged. Such aspects concern procedures and reporting of measurements and sampling, public information policies, etc. Also it might be value in alternating the basic set-up and scenario of the first exercise. Instead of assuming a hypothetical country having the accident, it could be assumed that the threat would come from a country not participating in the exercise, or that each country have an accident in a real plant.

In any case, before expanding too much on the design of new exercises, the Expert Group thinks that the experience from the first exercise has to be thoroughly evaluated.

Discussion on the Proposal

The main points made during the discussion of this proposal are found in the chapter "Conclusions and Recommendations".

SESSION V

CONCLUSIONS AND RECOMMENDATIONS

CHAIRMAN

J.O. SNIHS
(SWEDEN)

Summary and Conclusions

1. INTRODUCTION

The Workshop brought together some 50 experts with extensive experience in emergency planning and emergency exercises representing governments and industry in 18 member and three non-OECD member countries. The Chairman was Dr. J.O. Snihs from the Swedish Radiation Protection Institute.

The meeting included presentations from eight member countries, the CEC and the IAEA. Also, presentations were given about a training exercise carried out at Mol in Belgium and about a planned inter-Nordic exercise to be carried out in 1993. Finally, there were two presentations relating to the NEA programme of work in the field of off-site emergency exercises. The first one concerned the results from the survey on emergency exercise practices that recently was carried out by the NEA, and the second, was on the proposal by the NEA regarding the arrangement of international emergency exercises.

This summary contains the main conclusions from the workshop discussions and a list of "good practices" worthwhile keeping in mind when conducting off-site emergency exercises. This list was drawn from the papers presented and from the discussion. Finally, the summary contains the recommendations from the Workshop to the CRPPH concerning the Committee's plans for the arrangement of international emergency exercises.

2. CONCLUSIONS

It was evident from the presentations and discussions that a wealth of experience exists today from the conduct of emergency exercises. It seems that the approaches used in Member Countries to conduct exercises are largely the same, but the emphasis might be somewhat different depending on the particular features of the country in question. It is clear, however, that the sharing of experience and discussion on lessons learnt between countries are extremely useful. First, it gives Member Countries an indication of their own performance relative to others and, second, it might give them new ideas of ways to increase the efficiency of using exercises as a means to improve the quality of emergency arrangements.

It was evident from the meeting that some experience has now been gained in the field of bilateral exercises; a number of such exercises have been carried out so far, although most of them very limited in scope. It is, therefore, too early to draw far reaching conclusions from this experience other than to say that they have proven useful and very likely such exercises will continue.

Exercises are Key Elements in Emergency Arrangement

The various presentations clearly showed that emergency exercises form an integral part of the emergency arrangements in the Member Countries. In the wake of the TMI and Chernobyl accidents, most countries revised their emergency plans to take into account the experience gained and lessons learnt from the accident responses. Also, new guidance and conventions have been established internationally, having had an influence on the national arrangements. All this together have further emphasized the importance of carrying out emergency exercises, to regularly test the interplay between plans and procedures and to identify deficiencies.

From Table-tops to Field Exercises

Exercises are carried out with various levels of participation, from frequent utility exercises to test the operation of the on-site arrangements to less frequent national exercises involving the entire chain of organisations with responsibilities in man emergency.

To test different aspects of emergency provisions, different types of exercises are used. Experience shows that policy aspects are favorably developed and tested in exercises of so called table-top type, operating procedures in command-post exercises and, finally, actual operations in full field exercises. Finally, variations and combinations of these types are being used and were described during the meeting.

The Exercise Planning

The resources and time expended for planning the conduct of an exercise appear to be very cost effective and constitute one of the best expenditures of the exercise. The planning process normally starts with basic decisions on the aim, scope and duration of the exercise. It proceeds through the selection of the exercise objectives and participants, continues with the development of scenarios and incident lists and the production of the exercise inputs. Preparations require a planning organisation, a control group feeding the players with inputs,

evaluators, communications devices and, finally, logistical support. To accomplish this, some significant time needs to be allotted to the planning process, which consequently must start well in advance of the exercise.

Exercise Objectives

A general experience is also that the exercise objectives have to be clearly defined and realistic. The objectives provide both the basis for developing the scenario and a means for evaluating the response by the emergency organisation. The more specific the objectives, the easier it will be to determine whether the objectives were met or not. Exercise objectives must be realistic and possible to achieve in order to avoid the players dismissing the exercise as a game.

Scope and Duration of Exercises

The experience seems to be that it is wise to limit the scope of the exercises, and concentrate on either off-site or on-site aspects. To combine the two seems difficult, although it is done from time to time to increase the realism of exercises. Regarding the duration of exercises, it was the experience of the participants that exercises lasting several days are useful and quite common, but that exercises continuing throughout the night normally are not cost-effective.

Scenario

The scenario has to contain all the information that would be available in a real emergency for the participants to react realistically to an hypothetical accident, such as operational details, radiation levels in the plant and environmental measurements, as appropriate. The scenario should present a realistic and challenging situation to allow the participants to adequately test their procedures. Sometimes the scenario should include a release of radioactive substances to the environment, sometimes not, just a threat of a release. It was emphasized that a scenario should never be changed significantly during an exercise, since there is the risk of creating a great deal of confusion. What can be done, however, is to devote the first day of the exercise to reactor, or on-site matters, and then the second day to focus on off-site aspects, but all the time following the same scenario. It was also pointed out that one should avoid several time compressions during the same exercise, one or two are often unavoidable.

Support from Management

The single most important aspect affecting the success of an exercise is perhaps the support and attention of management. This relates to the planning process but also to the participation of management in the conduct and evaluation of the exercises. Support of top management gives justification to the exercise and could be seen as the profile, or importance, the organisation gives to emergency exercises. It was also mentioned that it may be difficult to involve politicians in exercises, particularly those on a national level. In some countries, local politicians are involved but the national ones are simulated.

Participation of the Public and the Media

Certain exercise objectives might be better achieved with the participation of the members of the public. Nevertheless general public is not normally involved. It seems to be the experience of most participants that the problems arising from an attempt to involve the public in exercises outweigh any benefit that may be gained. Some countries do, however, involve school children or volunteers to represent the public in limited activities, e.g. in monitoring and checking for contamination and in evacuation. It was also recognised that experience from public involvement in emergencies other than nuclear exists to a great deal in relation to incidents and accidents of a "conventional" kind. Therefore, by studying the lessons learnt from those events, useful experience would be gained. In the United States, for example, up to 90 evacuations are carried out annually due to accidents involving various health hazards. It was recommended by some participants that one should aim at establishing closer links between organisations responsible for nuclear and non-nuclear emergencies. In fact, many countries have established one organisation to be responsible for all kinds of emergencies, including nuclear.

The efficient testing of the emergency information function would require the involvement of the media. In some cases journalists accept to participate, but the experience seems to be that in general it is difficult to interest the media to play a role in an exercise, and second, if involved, they tend to treat the exercise itself as a news story, which is not the purpose. Instead, a solution seems to be to involve journalist students or media consultants to represent the media presence. One country reported about the production of real-time journals during the exercises as a means to increase the realism of exercises.

If not directly involved, the media and the public should be informed about upcoming exercises, including when and where they will take place. Not doing this may create misunderstandings and unpleasant surprises. The local press and

the radio, however, should be considered important partners in exercises, since they will play an important role in a real emergency.

The Various Phases of an Emergency

The challenges during the early phase of an emergency and those of the late phase are different and should be reflected in exercises. Emphasis has so far been on the early phase and the simulations of actions to be taken under time pressure. The late phase, however, involving ground contamination and/or contamination of foodstuff, requires another type of preparedness and it seems that more emphasis is being given by countries to exercises taking these aspects into consideration.

Exercises with International Flavour

Within the framework of bilateral and multinational emergency arrangements, a number of initiatives have been taken to use emergency exercises as a tool to increase coordination of the national emergency arrangements of neighbouring countries. Several examples of such exercises were mentioned, e.g. Germany-Switzerland-France, Sweden-Denmark and United States-Canada. Moreover, the IAEA started some time ago to carry out exercises to test its Emergency Response System set up on the basis of the Early Notification and Assistance Conventions adopted after the Chernobyl accident. A similar exercise programme has been set up by the Commission of the European Communities within its Urgent Radiological Information Exchange System, ECURIE. Both the IAEA and the CEC involve to some extent member countries in their exercises.

3. NEA SPONSORED EXERCISES

The initiative by the NEA to propose the arrangement of international exercises was presented and discussed by the participants. The aims of the programme as proposed by the NEA Expert Group on Emergency Exercises are to contribute to improved coordination of emergency response systems on a regional scale and to help in seeking consensus on approaches to the management of nuclear emergencies on an international level.

The Expert Group has proposed that in the first exercise, the Member Countries would be faced with a common scenario to which they should respond using their own emergency plans and procedures. After having

developed their responses, which is supposed to be done in small national table-tops, they would come together to an international meeting to discuss their respective actions.

The Workshop found the idea of international exercises interesting and thought it would contribute to the coordination of emergency response systems used in various countries. It was agreed to recommend to the NEA Committee on Radiation Protection and Public Health,

- that the first exercise should focus on international policy aspects of emergency arrangements, later on, however, more advanced exercises should be arranged involving also operational aspects;
- that the Committee make sure that the programme is coordinated with other major exercises being planned;
- that also countries without commercial nuclear installations can participate;
- that an Organising Committee, comprising all participants in the exercise, should be charged, together with the Expert Group, with preparing the first exercises; and, finally,
- that the first exercise could be arranged during spring 1993.

4. GOOD PRACTICES

Below are some good practices, which were drawn from the workshop presentations and discussions.

Planning, Objectives and Support of Management

- plan the exercise well, since good planning is one of the most cost-effective and important components of the exercise;
- make sure that the objectives you set are realistic and possible to achieve;
- make the exercises challenging; some flexibility should be given to controllers to inject supplementary information during exercises;

- involve top management in exercises; will increase the motivation of all participants;
- make sure that decision making is properly delegated and responsibilities clarified in advance of exercises;
- schedule exercises well in advance, in particular the ones involving management or political decision makers;
- be aware that early and late phase exercises are different, in the early phase every action has to be almost automatic, in the late phase more time for improvisations exists;
- be aware that there might be difficult to combine on-site and off-site exercises.

Conduct of Exercises

- use table-top exercises to test revised or new parts of emergency plan;
- use "canned" real meteorological data, if you need it for your scenario, otherwise real-time meteorology is often preferable;
- do not change a scenario during an exercise; may cause confusion jeopardizing the entire exercise;
- exercises which are designed to carry on overnight are normally not cost-effective; exercises over several days are useful, however;
- evaluate immediately the exercise experience, involve all participants in the evaluation, also management;
- analyse and take corrective actions.

Press and Public Involvement

- notify press and public of large exercises;
- remember that it may be somewhat "risky" to involve public directly in exercises, inform them that a large exercise will take place and make use of certain groups to simulate public;
- involve local media in exercises, your best support in a real emergency.

Other Good Practices

- consider producing a real-time exercise-journal during exercises, it makes the exercise more realistic and challenging;
- test your communications systems periodically and particularly before an exercise;
- update your telephone and telefax numbers regularly;
- agree on formats, units and language for reporting measurements;
- consider repeating the same exercise since people need periodic training and new "faces" will appear;
- introduce "normalisation points" for all players in large exercises to ensure all are working on the same assumptions for the remainder of the exercise;
- consider training sessions for exercise participants in advance of exercises.

International Aspects

- be aware that the terminology used in various countries is not the same, e.g. field exercise does not mean the same everywhere. Sheltering is another concept that has a different connotation;
- study well the emergency arrangements of the neighbouring country before conducting bilateral exercises;
- agree on communications systems, formats for exchanging information, measurement procedures and units, language, etc. in advance of bilateral exercises;
- consider nominating liaison officers in case of conducting bilateral exercises.

More "good practices" are found in the various papers in these proceedings.

Resumé et Conclusions

1. INTRODUCTION

La réunion de travail a rassemblé une cinquantaine d'experts possédant une vaste expérience de la planification des mesures d'urgence et des exercices d'application des plans en la matière, et représentant les pouvoirs publics et les milieux de l'industrie de 18 pays Membres et de trois pays non Membres de l'OCDE. La présidence de la réunion a été assurée par M. J.O. Snihs de l'Institut national de protection contre les radiations de Suède (SSI).

La réunion a donné lieu à des exposés présentés par huit pays Membres, la CCE et l'AIEA. Des communications ont aussi été consacrées à un exercice d'entraînement exécuté à Mol, en Belgique, et à un projet d'exercice d'application entre pays nordiques, auquel il sera procédé en 1993. Enfin, deux communications ont été présentées à propos du programme de travail de l'AEN dans le domaine des exercices d'application hors site des plans d'urgence. La première a porté sur les résultats d'une enquête relative aux pratiques dans ce domaine, qui a récemment été menée par l'AEN, et la seconde sur les propositions de l'AEN concernant l'organisation d'exercices internationaux d'application des plans d'urgence.

On trouvera dans le présent résumé, les principales conclusions qui se dégagent des débats pendant la réunion de travail, ainsi qu'une liste de "bonnes pratiques" qu'il convient de garder présentes à l'esprit lorsque l'on procède à des exercices d'application hors site des plans d'urgence. Cette liste est tirée des communications présentées et des débats. Enfin, le résumé contient les recommandations formulées, lors de la réunion de travail, à l'intention du CRPPH concernant les projets du Comité en vue d'organiser des exercices internationaux d'application des plans d'urgence.

2. CONCLUSIONS

Les exposés et les débats ont mis en évidence l'existence d'une abondante expérience acquise à l'occasion de la conduite d'exercices d'application des plans d'urgence. Il semble que les démarches adoptées dans les pays Membres

pour conduire ces exercices soient dans une large mesure les mêmes, mais il se pourrait qu'elles mettent l'accent sur des aspects assez différents, selon les caractéristiques particulières du pays considéré. Il est toutefois évident que la mise en commun de l'expérience acquise et les échanges de vues sur les enseignements tirés entre pays sont extrêmement utiles. Tout d'abord, ils donnent aux pays Membres une indication de leurs propres bons résultats par rapport aux autres, et d'autre part, ils pourraient leur donner de nouvelles idées sur la manière de conférer une plus grande efficacité au recours à des exercices en vue d'améliorer la qualité des dispositifs en cas d'urgence.

La réunion a mis en évidence le fait qu'une certaine expérience a maintenant été acquise dans le domaine des exercices bilatéraux : il a déjà été procédé à un certain nombre d'exercices de ce type, encore qu'ils aient, pour la plupart, été d'une portée très limitée. Il est donc prématuré de tirer

de cette expérience des conclusions très générales et il faut se contenter de constater que ces exercices se sont avérés utiles et qu'ils seront très probablement poursuivis.

Les exercices en tant qu'éléments clés du dispositif d'urgence

Les diverses communications ont clairement montré que les exercices d'application des plans d'urgence font partie intégrante des dispositifs d'urgence dans les pays Membres. A la suite des accidents de TMI-2 et de Tchernobyl, la plupart des pays ont révisé leurs plans d'urgence afin de prendre en compte l'expérience acquise et les enseignements tirés des interventions à l'occasion de ces accidents. En outre, de nouvelles directives et conventions, élaborées au plan international, ont eu une incidence sur les dispositifs nationaux. Globalement, il importe donc d'autant plus d'exécuter des exercices d'application des plans d'urgence, afin de tester régulièrement l'influence réciproque de ces plans et procédures et d'en déceler les imperfections.

Des simulations théoriques aux exercices sur le terrain

Les exercices sont menés à divers niveaux de participation : il peut s'agir aussi bien des exercices fréquents exécutés par la compagnie d'électricité pour tester le fonctionnement des dispositifs sur le site, que des exercices nationaux moins fréquents mettant en jeu toute la chaîne des organisations auxquelles des responsabilités sont dévolues dans une situation d'urgence.

Afin de tester différents aspects des dispositions en cas d'urgence, on a recours à divers types d'exercices. L'expérience montre que les exercices du

type simulation théorique (table-top exercises) permettent de bien mettre au point et tester les aspects liés à l'action des pouvoirs publics, les exercices aux postes de commande (command-post exercises) les procédures d'exécution, et les exercices complets sur le terrain (full field exercises) les opérations effectives. Enfin, des variantes et des combinaisons de ces types d'exercices sont utilisées et ont été décrites au cours de la réunion.

La planification de l'exercice

Les ressources et le temps consacrés à planifier l'exécution d'un exercice semblent très rentables et constituent l'une des dépenses les plus efficaces liées à l'exercice. Le processus de planification part en règle générale des décisions fondamentales sur le but, la portée et la durée de l'exercice. Il se poursuit par la sélection des objectifs et des participants, puis par la mise au point de scénarios et de listes d'incidents, et par l'établissement des données d'entrée destinées à l'exercice. Les préparatifs exigent un organisme de planification, un groupe témoin fournissant des données d'entrée aux intervenants, des évaluateurs, des dispositifs de communications et enfin un soutien logistique. Pour ce faire, il faut consacrer un laps de temps important au processus de planification, lequel doit, par conséquent, débiter bien avant l'exercice.

Objectifs de l'exercice

L'expérience générale semble aussi indiquer que les objectifs de l'exercice doivent être clairement définis et réalistes. Ces objectifs offrent à la fois la base permettant d'élaborer le scénario et un moyen pour évaluer la réaction de l'organisme d'intervention en cas d'urgence. Plus les objectifs sont spécifiques, plus il sera facile de déterminer s'ils sont bien atteints. Les objectifs de l'exercice doivent être réalistes et possibles à réaliser, afin d'éviter que les intervenants ne se débarassent de l'exercice comme d'un jeu.

Portée et durée des exercices

L'expérience montre, semble-t-il, qu'il est sage de limiter la portée des exercices, et de se concentrer sur les aspects soit hors site, soit sur le site. Il paraît difficile d'associer les deux, bien que cela se fasse de temps en temps afin d'accroître le réalisme des exercices. En ce qui concerne la durée des exercices, d'après l'expérience des participants, des exercices durant plusieurs jours sont utiles et assez courant, mais des exercices se poursuivant pendant la nuit ne sont normalement pas rentables.

Scénario

Le scénario doit contenir toutes les informations qui seraient disponibles dans une véritable situation d'urgence, pour que les intervenants réagissent de façon réaliste à un accident hypothétique, s'agissant par exemple des détails opérationnels, des niveaux de rayonnement dans la centrale et des mesures dans l'environnement, le cas échéant. Le scénario devrait présenter une situation réaliste et stimulante pour permettre aux participants de tester convenablement leurs procédures. Parfois, le scénario devrait inclure un rejet de substances radioactives dans l'environnement, et parfois pas, ne comportant qu'une menace de rejet. On a souligné qu'un scénario ne devrait jamais être modifié notablement au cours d'un exercice, car cela risque de créer beaucoup de confusion. Ce qu'il est possible de faire cependant, c'est de consacrer la première journée d'un exercice au réacteur ou aux affaires sur le site, et ensuite, la seconde journée, de s'axer sur les aspects hors-site, mais en suivant tout le temps le même scénario. On a aussi fait observer qu'il convient d'éviter plusieurs compressions de temps au cours du même exercice.

Soutien apporté par la direction

Le facteur à lui seul le plus important, qui détermine le succès d'un exercice, est peut-être le soutien et l'attention apportés par la direction. Cela s'applique au processus de planification, mais aussi à la participation de la direction à la conduite et à l'évaluation des exercices. Le soutien de la haute direction fournit une justification à l'exercice et pourrait être considéré comme révélateur de l'importance accordée aux exercices d'application des plans d'urgence, ou de l'optique dans laquelle elle les envisage. Il a aussi été fait état des difficultés pouvant être rencontrées pour obtenir la participation aux exercices des responsables politiques, en particulier à un niveau national. Dans certains pays, les responsables locaux sont impliqués, mais la participation des responsables nationaux est simulée.

Participation du public et des médias

La meilleure façon d'atteindre certains objectifs des exercices serait de s'assurer la participation de personnes du public. Néanmoins, le grand public n'est normalement pas impliqué. L'expérience de la plupart des participants semble indiquer que les problèmes suscités par une tentative en vue d'associer le public aux exercices, l'emportent sur les éventuels avantages qui en seraient tirés. Certains pays, cependant, font participer des enfants des écoles ou des volontaires qui représentent le public à des activités limitées, par exemple à la surveillance et au contrôle de la contamination et à l'évacuation. Il a aussi été

reconnu que l'expérience que l'on possède de la participation du public dans des situations d'urgence autres que nucléaires, vise dans une large mesure des incidents et accidents de type "classique". C'est pourquoi, d'utiles données d'expérience seraient obtenues de l'étude des enseignements tirés de ces événements. Aux Etats-Unis, par exemple, de l'ordre de 90 évacuations sont effectuées chaque année par suite d'accidents entraînant divers risques pour la santé. Certains participants ont recommandé qu'il y aurait lieu de resserrer les liens entre organismes en charge des urgences nucléaires et non nucléaires. En fait, de nombreux pays ont établi un organisme unique qui est chargé de tous les types d'urgences, y compris nucléaires.

Pour tester de façon efficace la fonction d'information en cas d'urgence, il faudrait s'assurer la participation des médias. Dans certains cas, des journalistes acceptent de participer, mais l'expérience semble montrer qu'il est en général difficile d'intéresser les médias pour les amener à jouer un rôle dans un exercice et, en second lieu, s'ils y participent, ils ont tendance à traiter l'exercice lui-même comme un "scoop", ce qui n'est pas le but recherché. La solution semble être plutôt d'obtenir la participation d'étudiants en journalisme ou de consultants des médias, pour représenter la présence des médias. Un pays a fait état de l'établissement de journaux en temps réel pendant les exercices, s'agissant d'un moyen d'accroître le réalisme de ces derniers.

S'ils ne sont pas directement impliqués, les médias et le public devraient être informés des exercices à venir, notamment du moment et de l'endroit où ils auront lieu. Si cela n'est pas fait, il pourrait en résulter des malentendus et des surprises déplaisantes. La presse locale et la radio devraient être considérées comme d'importants partenaires dans les exercices, car dans une situation d'urgence réelle, elles auront un rôle notable à jouer.

Les diverses phases d'une urgence

Les enjeux au cours de la phase initiale d'une urgence et ceux de la phase tardive, sont différents et il y a lieu d'en tenir compte dans les exercices. L'accent a jusqu'à présent été mis sur la phase initiale et sur les simulations des interventions à effectuer sous la pression des événements. La phase tardive, toutefois, impliquant la contamination du sol et/ou la contamination des denrées alimentaires, exige un autre type d'état de préparation et il semble que les pays privilégient maintenant davantage les exercices tenant compte de ces aspects.

Exercices à "coloration" internationale

Dans le cadre d'arrangements bilatéraux et multilatéraux en cas d'urgence, on a pris un certain nombre d'initiatives en vue d'utiliser les exercices

d'application des plans d'urgence comme instrument permettant d'améliorer la coordination des dispositifs d'urgence nationaux de pays voisins. Plusieurs exemples de tels exercices ont été mentionnés, par exemple ceux associant l'Allemagne, la Suisse et la France, la Suède et le Danemark, et les Etats-Unis et le Canada. En outre, l'AIEA a entrepris, il y a un certain temps, de procéder à des exercices en vue de tester son Système d'intervention en cas d'urgence, établi sur la base des Conventions sur la notification rapide et sur l'assistance en cas d'accident nucléaire ou de situation d'urgence radiologique adoptées à la suite de l'accident de Tchernobyl. Un programme d'exercices analogue a été établi par la Commission des Communautés Européennes dans le cadre de son Système d'échange d'informations radiologiques urgentes "ECURIE". L'AIEA, comme la CCE, font dans une certaine mesure participer des pays Membres à leurs exercices.

3. EXERCICES PATRONNÉS PAR L'AEN

L'initiative de l'AEN de proposer l'organisation d'exercices internationaux a été présentée et les participants en ont débattu. Les finalités de ce programme, telles qu'elles sont proposées par le Groupe d'experts de l'AEN sur les exercices d'application des plans d'urgence, consistent à contribuer à améliorer la coordination des plans d'intervention en cas d'urgence à l'échelle

régionale, et à aider à rechercher un consensus sur les démarches adoptées à l'égard de la gestion des urgences nucléaires au niveau international.

Le Groupe d'experts a proposé que, dans le premier exercice, les pays Membres aient à faire face à un scénario commun, auquel ils auraient à répondre en utilisant leurs propres plans et procédures d'urgence. Après avoir mis au point leurs interventions, ce qui est supposé être réalisé au cours de simulations théoriques à échelle réduite au plan national, ils se rendraient à une réunion internationale afin d'examiner les mesures respectivement prises.

Les participants à la réunion de travail ont jugé l'idée d'exercices internationaux intéressante et ont estimé que cela contribuerait à la coordination des systèmes d'intervention en cas d'urgence utilisés dans les divers pays. Ils sont convenus de recommander au Comité AEN de protection radiologique et de santé publique (CRPPH) :

- d'axer le premier exercice sur les aspects de politique internationale des arrangements en cas d'urgence puis, ultérieurement, d'organiser des exercices plus poussés mettant également en jeu des aspects opérationnels ;

- de veiller à ce que ce programme soit coordonné avec d'autres importants exercices actuellement projetés ;
- de donner aussi à des pays ne possédant pas d'installations nucléaires commerciales la possibilité d'y participer ;
- de charger un Comité d'organisation, comprenant tous les participants à l'exercice, de préparer, conjointement avec le Groupe d'experts, ce premier exercice ; et enfin
- d'envisager d'organiser le premier exercice au cours du printemps de 1993.

4. BONNE PRATIQUES

On trouvera ci-après une liste de certaines bonnes pratiques, qui se sont dégagées des exposés et des débats auxquels a donné lieu la réunion.

Planification, objectifs et soutien de la direction

- Bien planifier l'exercice, car une bonne planification est l'un des aspects les plus rentables et les plus importants de l'exercice ;
- S'assurer que les objectifs fixés sont réalistes et possibles à réaliser ;
- Rendre les exercices stimulants : une certaine souplesse devrait être ménagée permettant aux contrôleurs d'injecter des informations supplémentaires pendant le déroulement des exercices ;
- Faire participer la haute direction aux exercices de manière à accroître la motivation de tous les participants ;
- S'assurer que la prise de décision est convenablement déléguée et que les responsabilités sont clairement définies avant les exercices ;
- Programmer les exercices bien à l'avance, en particulier ceux impliquant la direction ou des décideurs ;

- Etre conscient du fait que les exercices portant sur les phases précoces et tardives sont différents, au cours de la phase précoce, chaque intervention devant être quasi automatique, alors que pendant la phase tardive, on dispose de plus de temps pour des improvisations ;
- Etre conscient du fait qu'il pourrait être difficile d'associer des exercices sur le site et hors du site.

Conduite des exercices

- Recourir à des simulations théoriques afin de tester des parties révisées ou nouvelles du plan d'urgence ;
- Utiliser des données météorologiques réelles "en boîte", si le scénario l'exige, sinon il est souvent préférable de recourir à la météorologie en temps réel ;
- Ne pas modifier un scénario en cours d'exercice, car cela peut être une cause de confusion risquant de compromettre tout l'exercice ;
- Eviter les exercices conçus pour se prolonger le jour suivant, car ils ne sont normalement pas rentables ; toutefois, des exercices sur plusieurs jours sont utiles;
- Evaluer immédiatement l'expérience acquise à la suite de l'exercice en associant à cette évaluation tous les participants ainsi que la direction ;
- Analyser les résultats et prendre des mesures correctives.

Participation de la presse et du public

- Signaler les exercices importants à la presse et au public ;
- Ne pas oublier qu'il peut être quelque peu "hasardeux" d'impliquer directement le public dans des exercices, l'informer qu'un exercice important va se dérouler, et recourir à certains groupes pour simuler le public ;

- Faire participer les médias locaux aux exercices, car il s'agit du meilleur soutien susceptible d'être obtenus dans une situation d'urgence réelle.

Autres bonnes pratiques

- Penser à faire tenir un journal en temps réel au cours des exercices, car cela confère davantage de réalisme et d'intérêt à l'exercice ;
- Tester périodiquement les systèmes de communications, en particulier avant un exercice ;
- Mettre à jour régulièrement les numéros de téléphone et de télécopie ;
- Se mettre d'accord sur les formulaires, les unités et la terminologie à utiliser pour rendre compte des mesures ;
- Envisager de recommencer le même exercice, car les gens ont besoin d'une formation périodique, et il y aura de nouvelles "têtes" ;
- Introduire des "points de normalisation" pour tous les intervenants dans de grands exercices, afin de faire en sorte qu'ils opèrent tous sur la base des mêmes hypothèses pendant le reste de l'exercice;
- Envisager des séances de formation pour les participants aux exercices préalablement à ces derniers.

Aspects internationaux

- Prendre conscience du fait que la terminologie utilisée dans divers pays n'est pas la même, par exemple, un exercice sur le terrain ne signifie par partout la même chose, le confinement dans des locaux étant une autre notion qui a des connotations différentes ;
- Bien étudier les dispositifs en cas d'urgence du pays voisin avant de mener des exercices bilatéraux ;

- Convenir de systèmes de communications, de formulaires pour l'échange d'informations, de procédures et d'unités de mesure, d'une terminologie, etc. préalablement aux exercices bilatéraux;
- Examiner la désignation d'agents de liaison en cas d'exercices bilatéraux.

On trouvera d'autres "bonnes pratiques" dans les diverses communications reproduites dans le présent compte rendu.

LIST OF PARTICIPANTS

AUSTRIA - AUTRICHE

KAUDEL, G., Division for the Coordination of the Federal Crisis Management, Austrian Federal Chancellery, Ballhausplatz 2, A - 1014 Vienna

ZECHNER, J.E., Federal Ministry of Health, Sports and Consumer Protection, Radetzkystr. 2, A-1031 Vienna

BELGIUM - BELGIQUE

GOVAERTS, P., S.C.K./C.E.N., Radiation Protection Research Unit, Boeretang 200, B-2400 Mol

VREYS, H., Min. Santé Publique et Environnement, S.P.R.I., Quartier Vésale 2/3, C.A.E., B-1010 Brussels

ZEEVAERT, T., S.C.K./C.E.N., Radiation Protection Research Unit, Boeretang 200, B-2400 Mol

CANADA

ALI, F.B., Nuclear Emergency Preparedness, Ministry of the Solicitor General, 27 Carlton Street, 5th Floor, Toronto, Ontario M5B 1L2

BOND, J.A., Radiation and Industrial Safety Branch, AECL Research, Chalk River Laboratories, Chalk River, Ontario

FOWLES, G.A., Ontario Hydro Emergency Preparedness, Nuclear Operations Branch, 700 University Ave. (A8-H3), Toronto, Ontario M5G 1X6

QUANCE, G.E., Ontario Hydro Emergency Preparedness, Exercise Design and Evaluation, Nuclear Operations Branch, 700 University Ave. (A8-H3), Toronto, Ontario M5G 1X6

FINLAND - FINLANDE

SINKKO, K.T.S., Finnish Centre for Radiation and Nuclear Safety, P.O. Box 268, SF-00101 Helsinki

FRANCE

GINOT, P., Commissariat à l'Énergie Atomique, Institut de Protection et de Sécurité Nucléaire, B.P. No. 6, 92265 Fontenay-aux-Roses Cedex

GERMANY - ALLEMAGNE

BAYER, A., Bundesamt für Strahlenschutz, Institut für Strahlenhygiene, Postfach 1108, D-8042 Neuherberg

LANGE, J., Bundesministerium für Umwelt, Naturschutz und Reaktorsicherheit, Postfach 12 06 29, 5300 Bonn 1

MISKA, H., Ministerium des Innern und für Sport Rheinland - Pfalz Schillerplatz 3-5, D6500 Mainz

ICELAND - ISLANDE

MAGNUSSON, S.M., National Institute of Radiation Protection (Geislavarnir-rikisins), Laugavegur 118D, Reykjavik

IRELAND - IRELANDE

CUNNINGHAM, J.D., Nuclear Energy Board, 3 Clonskeagh Square, Clonskeagh, Dublin 14

FLANAGAN, G., Department of Energy, 25 Clare Street, Dublin 2

POLLARD, D., Nuclear Energy Board, 3 Clonskeagh Square, Clonskeagh, Dublin 14

ITALY - ITALIE

ROBERTI, M., ENEA - DISP, Via Vitaliano Brancati 48, 00144 Rome

ROLLO, C., ENEA - DISP, Via Vitaliano Brancati 48, 00144 Rome

JAPAN - JAPON

FUKUYAMA, S., Section of Emergency Services, Division of Emergency Planning and Preparedness, Nuclear Safety and Technology Center, Tokyo Toyamakaikan 3F, S-1-3-101 Hakusan, Bunkyo-ku, Tokyo

OSHINO, M., Department of Health Physics, JAERI, Tokai Research Establishment, Tokai-mura, Naka-gun, Ibaraki-ken, 319-11

SUGIYMA, S., Fire Defence and Disaster Prevention, Disaster Prevention Bureau, Shizuoka Prefectural Government

URUSHIHARA, E., Science and Technology Agency, 2-2-1 Kasumigaseki, Chiyoda-ku, Tokyo 100

LUXEMBOURG

KAYSER, P., Ministère de la Santé et Direction de la Protection Civile, 1 avenue des Archiducs, L-1135 Luxembourg

THE NETHERLANDS - PAYS-BAS

BERGMAN, L.J., Ministry of Housing, Physical Planning and Environment, P.O. Box 450, 2260 MB Leidschendam

CORNET, J.P., Ministry of Housing, Physical Planning and Environment, P.O. Box 450, 2260 MB Leidschendam

DAL, A.H., Ministry of Housing, Physical Planning and Environment, P.O. Box 450, 2260 MB Leidschendam

FUNDTER, D.Q., Directorate Fire Brigades, Ministry of the Interior, Schedeldoekshaven 200, 2500 EA Den Haag

van PINXTEREN, Ministry of the Interior, Schedeldoekshaven 200, 2500 EA Den Haag

NORWAY - NORVEGE

STRANDEN, E., Norwegian Nuclear Energy Safety Authority, P.O. Box 750 Sentrum, N-0106 Oslo 1

POLAND - POLOGNE

MERTA, A.J., National Atomic Energy Agency, 00-921 Warszawa ul Krucza 36

ROMANIA - ROUMANIE

SANDRU, P., Institute of Atomic Physics, P.O. Box MG-6, Bucharest - Magurele

SLOVENIA - SLOVENIE

SKRABAN, A., Republican Administration for Nuclear Safety, Kardeljeva Ploščad 24, 61000 Ljubljana Slovenia

SPAIN - ESPAGNE

ROMAN, S., Civil Protection Directorate, Plaza Imperial Tanaco,
3 Tarragona 43005

VERA, I., Civil Protection Directorate, Evaristo San Miguel 8, Madrid 28008

SWEDEN - SUEDE

PERSSON, B.Å., Swedish Radiation Protection Institute, Box 60204,
S-10401 Stockholm

SNIHS, J.O., Swedish Radiation Protection Institute, Box 60204, S-10401
Stockholm

WALLIN, M., Swedish Radiation Protection Institute, Box 60204, S-10401 Stockholm

SWITZERLAND - SUISSE

BAGGENSTOS, M., Swiss Nuclear Safety Inspectorate, 5232 Villigen - HSK

KNAUS, H.J., Federal Department of Interior, Secretariat General, National
Emergency and Operation Centre, Postfach CH-8044, Zurich

UNITED KINGDOM - ROYAUME-UNI

JACKSON, R.L., Department of the Environment, Room A534, Romney House,
43 Marsham Street, London SW1P 3PY

LINDLEY, A.J., HM Nuclear Installations Inspectorate, St. Peter's House,
Balliol Road, Bootle Merseyside, L20 3LZ

MEHEW, R.D., HM Nuclear Installations Inspectorate, St. Peter's House,
Balliol Road, Bootle Merseyside, L20 3LZ

UNITED STATES - ETATS-UNIS

CARNES, W.E., Office of Nuclear Safety, Department of Energy,
19901 Germantown Rd., Germantown, Maryland 20847

FAIROBENT, J., Emergency Management Division (DP 9.3), Department of Energy,
1000 Independence Ave., Washington, D.C. 20588

HIMMELSBACH, L., Emergency Management Division, Department of Energy,
1000 Independence Ave., Washington, D.C. 20585

ROHRER, D.M., Program Performance Assessment Division (EH-413), Office of
Health, US Department of Energy, Washington, D.C. 20545

COMMISSION OF THE EUROPEAN COMMUNITIES - COMMISSION DES COMMUNANTES EUROPEENNES

FRASER, G., Directorate-General, Environment, Nuclear Safety & Civil Protection,
XI-A-1 Radiation Protection, Commission of the European Communities,
Centre Wagner C.353, Plateau du Kirchberg, L-2920 Luxembourg

INTERNATIONAL ATOMIC ENERGY AGENCY -
AGENCE INTERNATIONALE DE L'ENERGIE ATOMIQUE

WEISS, B.H., Emergency Assistance Services, Division of Nuclear Safety,
International Atomic Energy Agency, Wagramerstrasse 5, P.O. Box 100,
A-1400 Vienna

INTERNATIONAL RADIATION PROTECTION ASSOCIATION -
ASSOCIATION INTERNATIONALE DE RADIOPROTECTION

HUYSKENS, C.J., International Radiation Protection Association, Eindhoven
University of Technology, P.O. Box 662, 5600 AR Eindhoven

LAKEY, J.R.A., International Radiation Protection Association, c/o John Lakey
Associates, 5 Pine Rise, Meopham, Gravesend, Kent DA13 0JA

NUCLEAR ENERGY AGENCY - AGENCE POUR L'ENERGIE NUCLEAIRE

VIKTORSSON, C., Radiation Protection and Waste Management Division, OECD Nuclear
Energy Agency, 38 boulevard Suchet, 75016 Paris